

# CEL 774 CONSTRUCTION PRACTISES

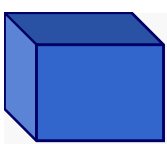

*Concrete: Production  
(Pre-stressing )*

*B. Bhattacharjee*

**CIVIL ENGINEERING DEPARTMENT  
IIT DELHI**



DEPARTMENT OF CIVIL ENGINEERING, IIT DELHI

# *General Outline*

- **Examples**
- **Mass Concrete**
- **Cold weather problem**
- **Concreting in cold weather**



B. Bhattacharjee

DEPARTMENT OF CIVIL ENGINEERING, IIT DELHI

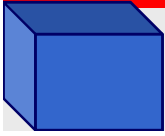

# EXAMPLES

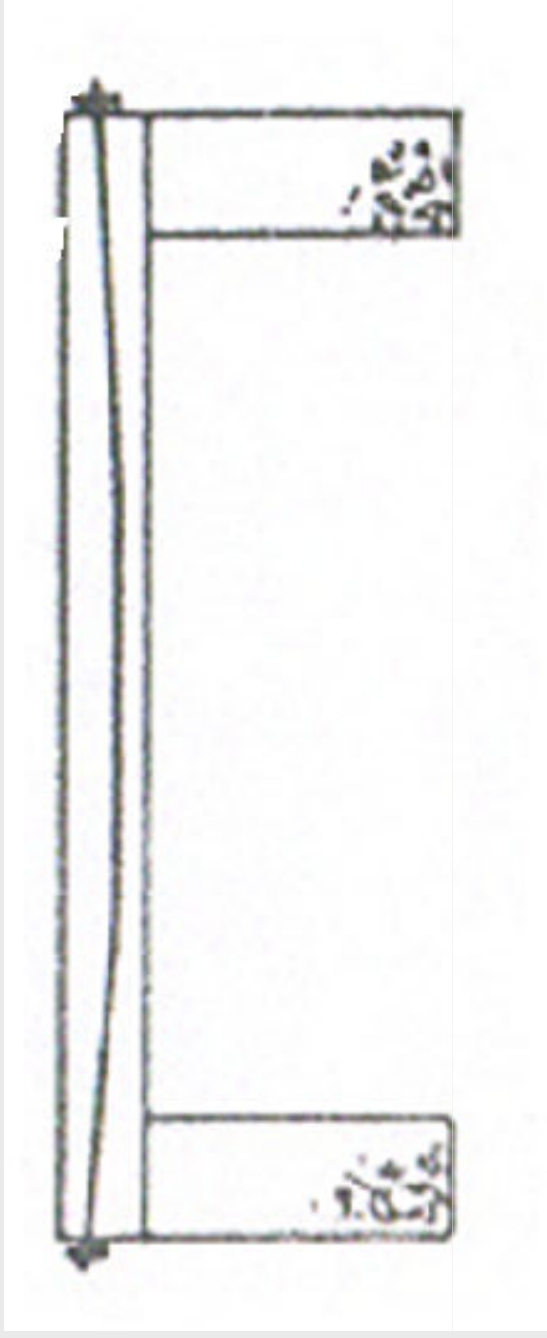
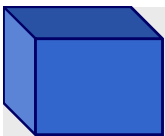

B. Bhattacharjee  
DEPARTMENT OF CIVIL ENGINEERING, IIT DELHI

# EXAMPLES

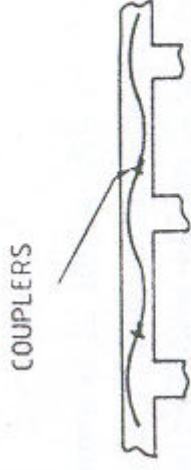

**Figure 30.2(a)**  
Continuous deck with  
tendon coupling

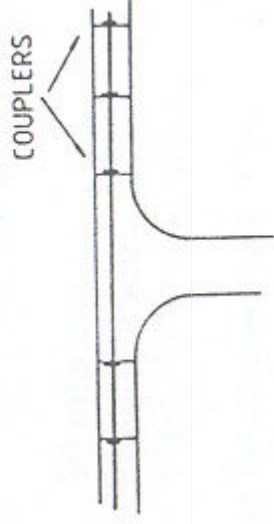

**Figure 30.2(b)** Bridge  
deck with tendon  
couplings

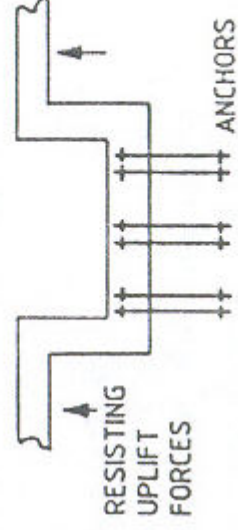
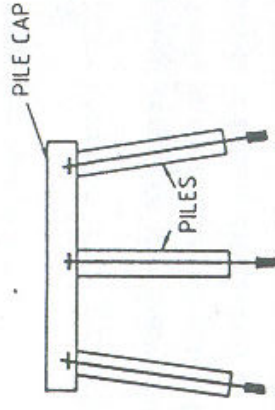

**Figure 30.3(a)**  
Basement anchors



# EXAMPLES

**Figure 30.3(b)**  
Foundation anchors



**Figure 30.4** Cables  
anchorage

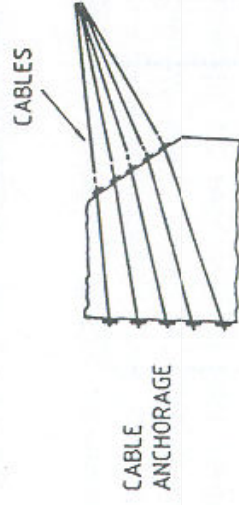

**Figure 30.5** Rock  
bolting

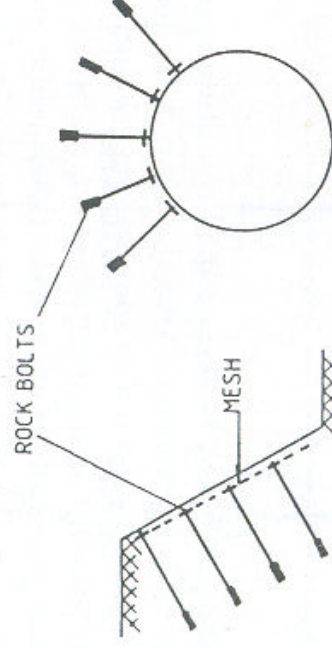

# EXAMPLES

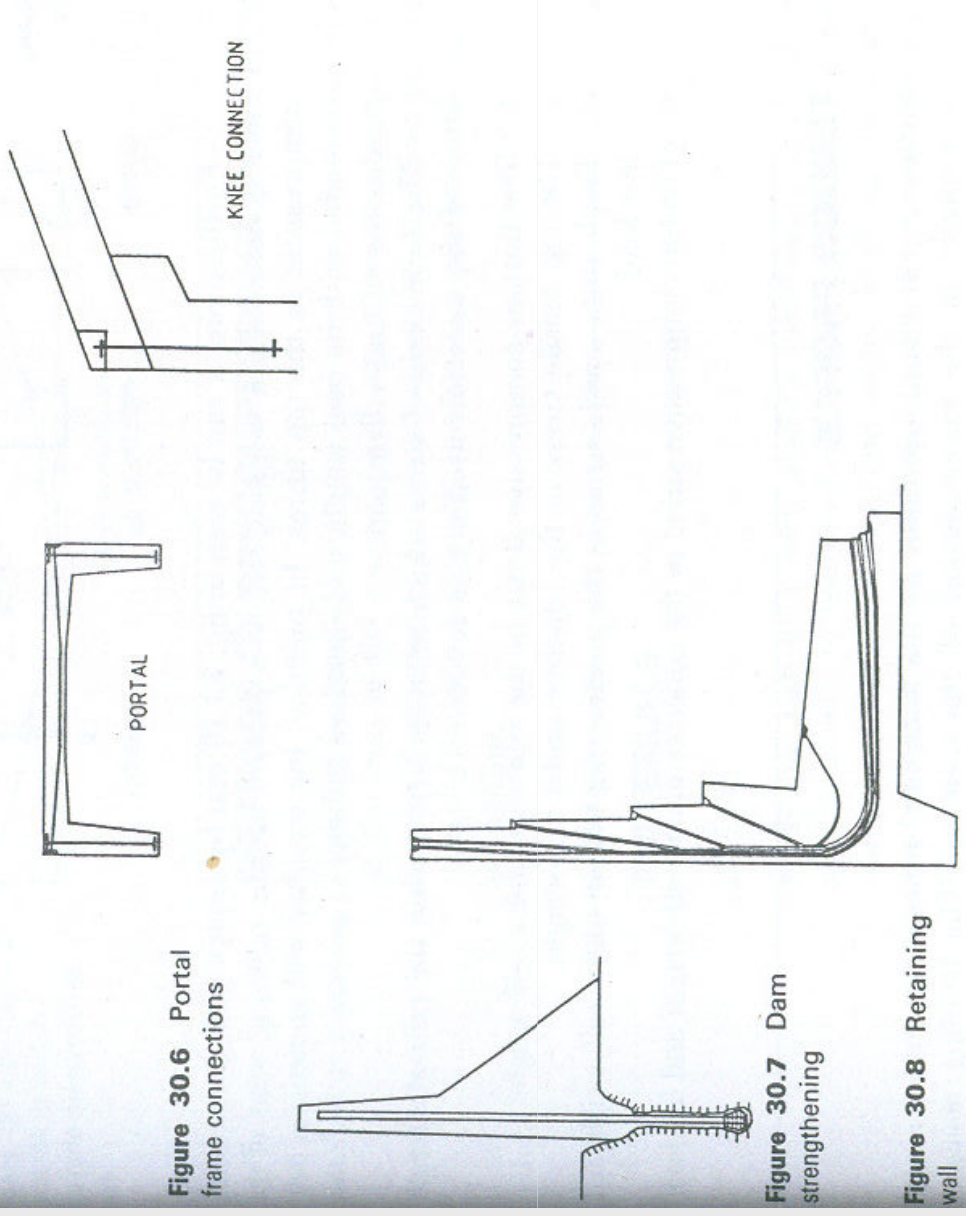

B. Bhattacharjee  
DEPARTMENT OF CIVIL ENGINEERING, IIT DELHI

# PROFILE

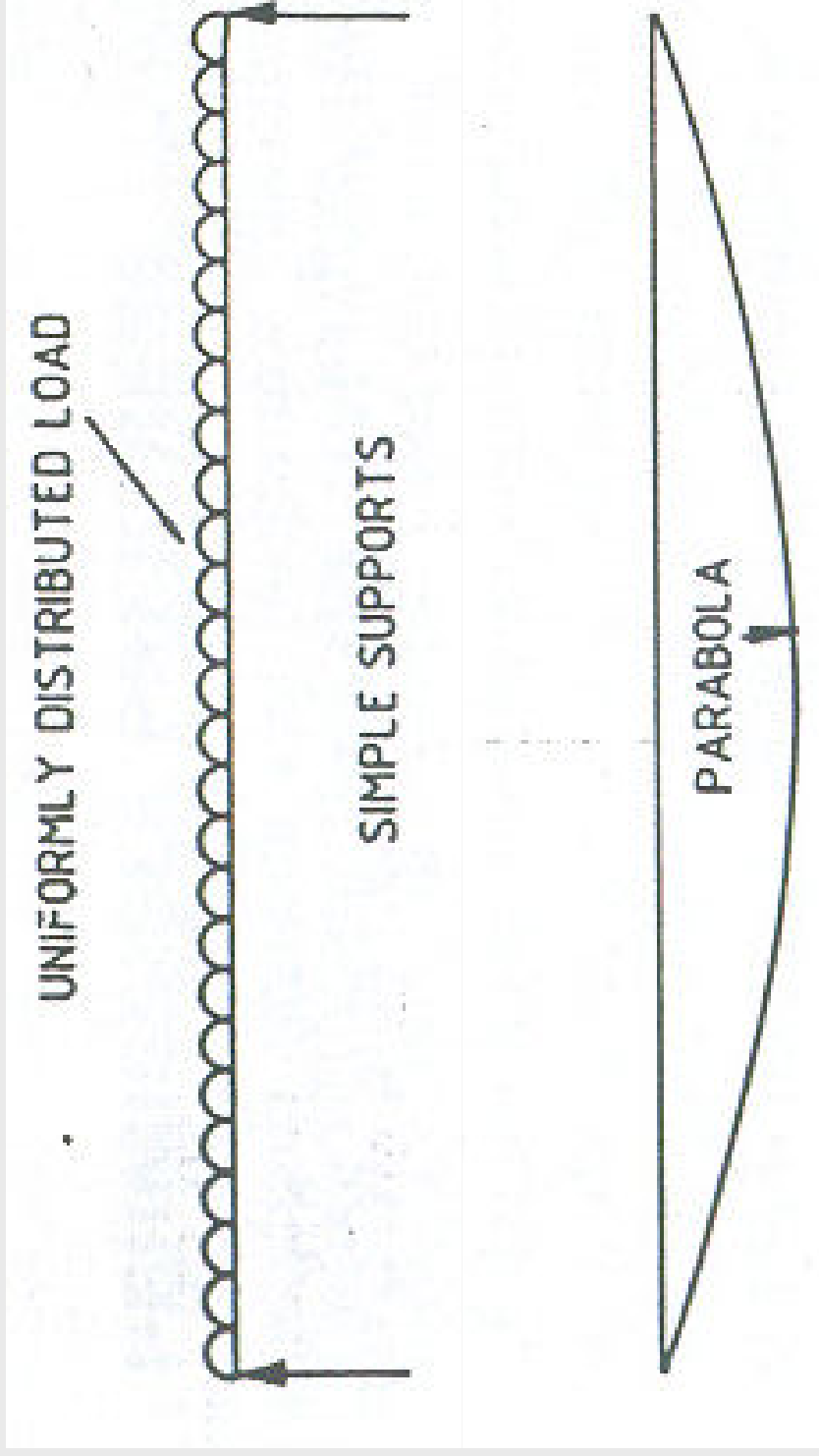

# PROFILE

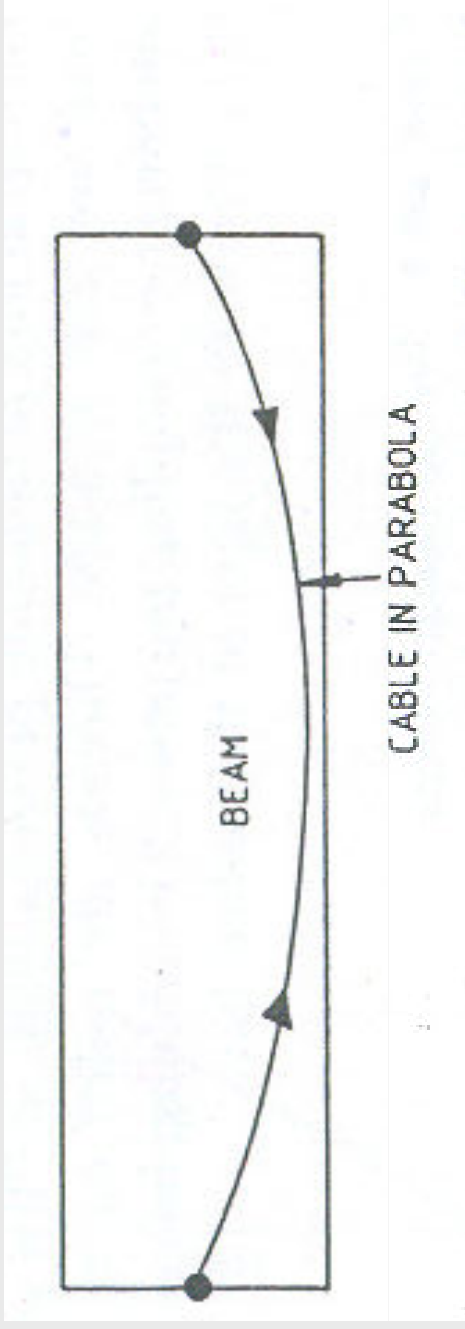

B. Bhattacharjee  
DEPARTMENT OF CIVIL ENGINEERING, IIT DELHI



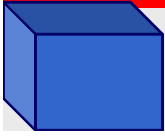

# STRAND

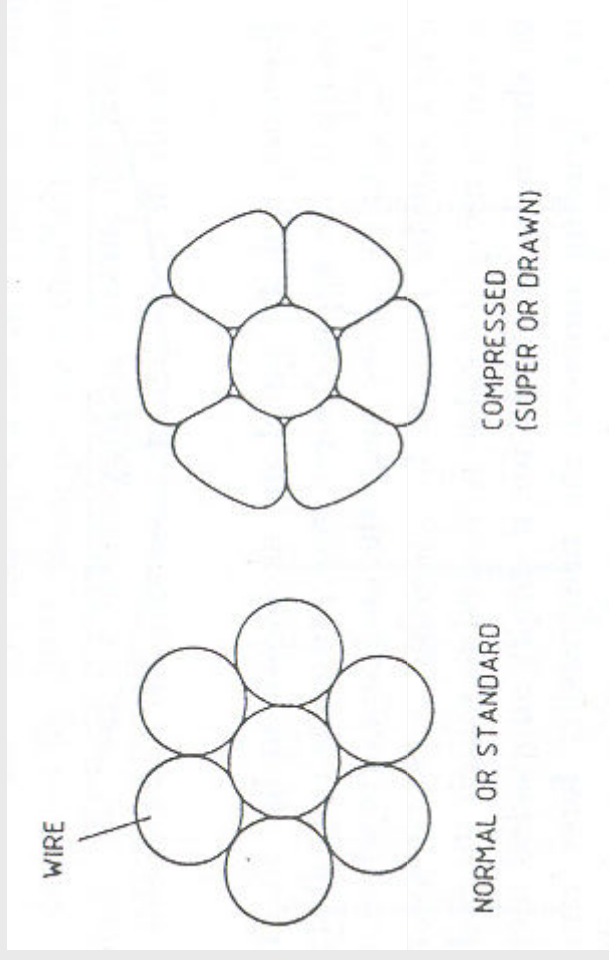
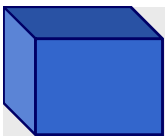

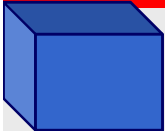

# LONGLINE METHOD

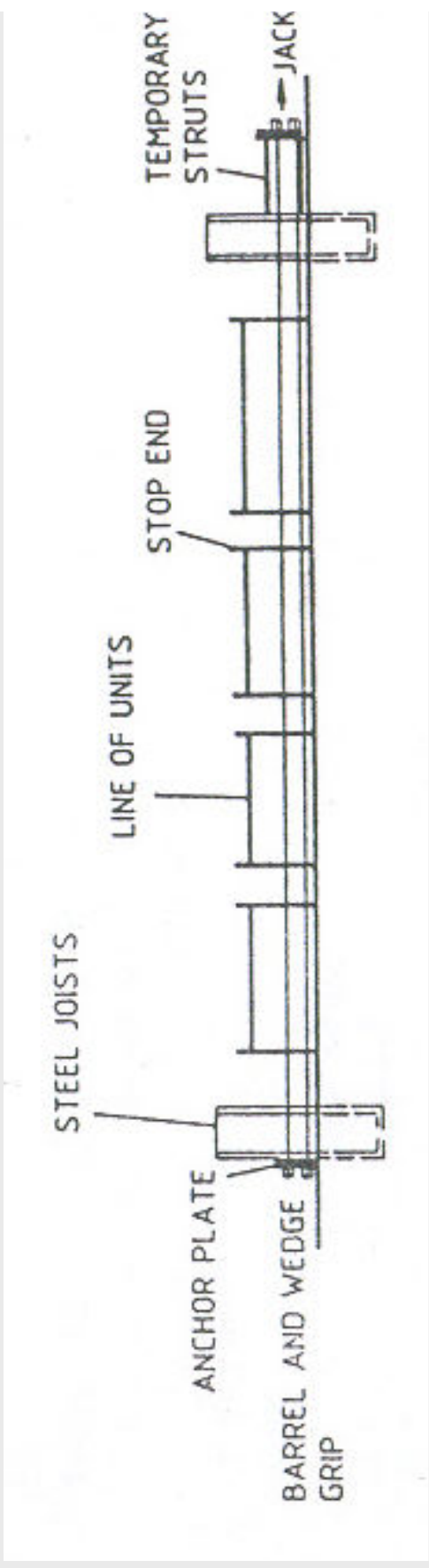
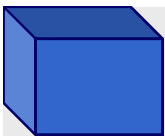

B. Bhattacharjee  
DEPARTMENT OF CIVIL ENGINEERING, IIT DELHI

# DUCT PROFILE

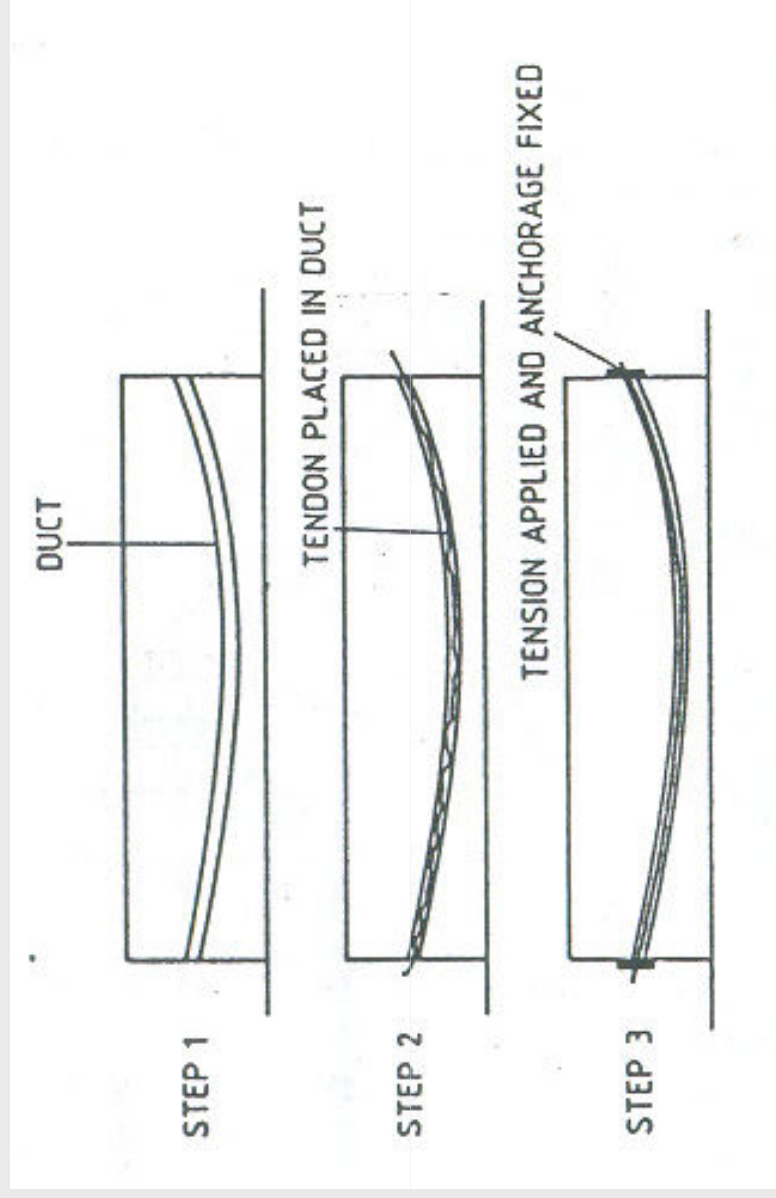

B. Bhattacharjee  
DEPARTMENT OF CIVIL ENGINEERING, IIT DELHI

# THREADED BAR & NUT SYSTEM

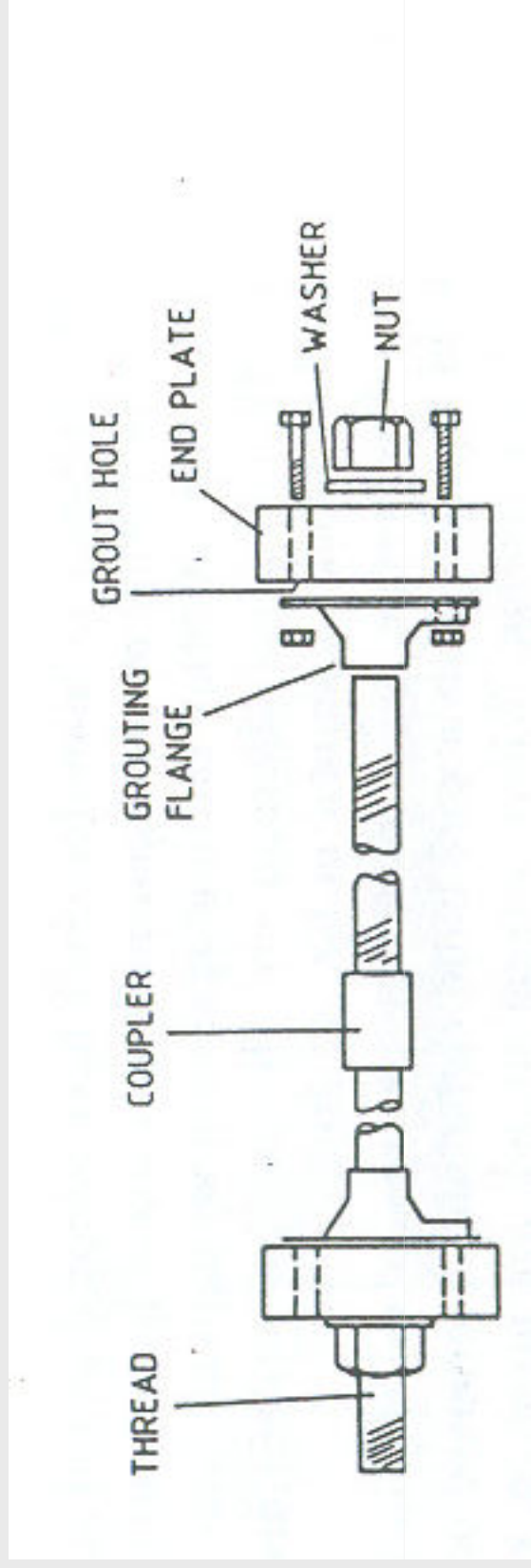

**TRANSFER OF TENSION THROUGH NUT & WASHER TO A SOLID PLATE, BEARING AGAINST CONCRETE**



B. Bhattacharjee

DEPARTMENT OF CIVIL ENGINEERING, IIT DELHI

# JACK

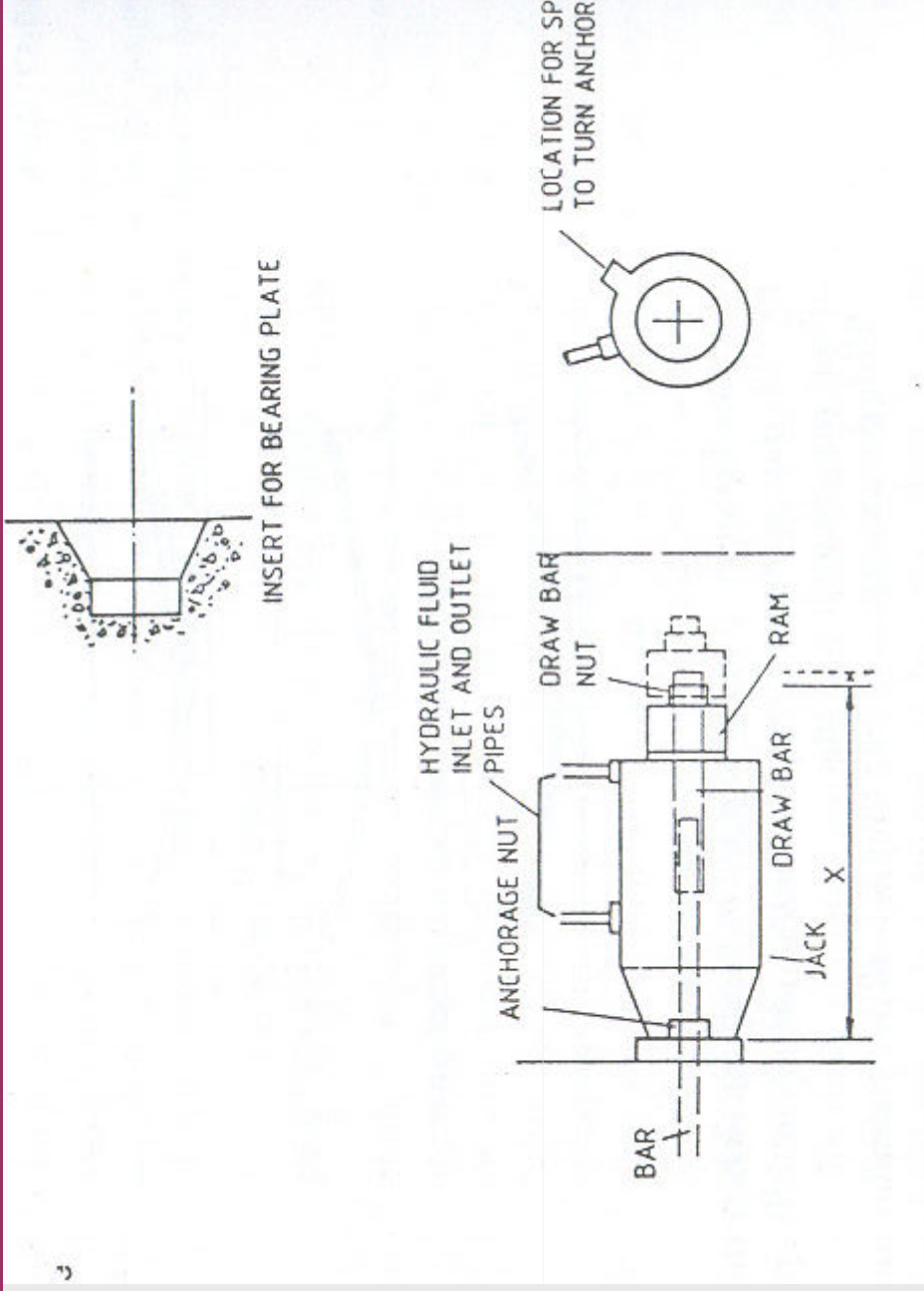

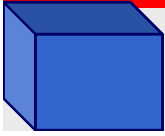

# BARREL & WEDGE SYSTEM

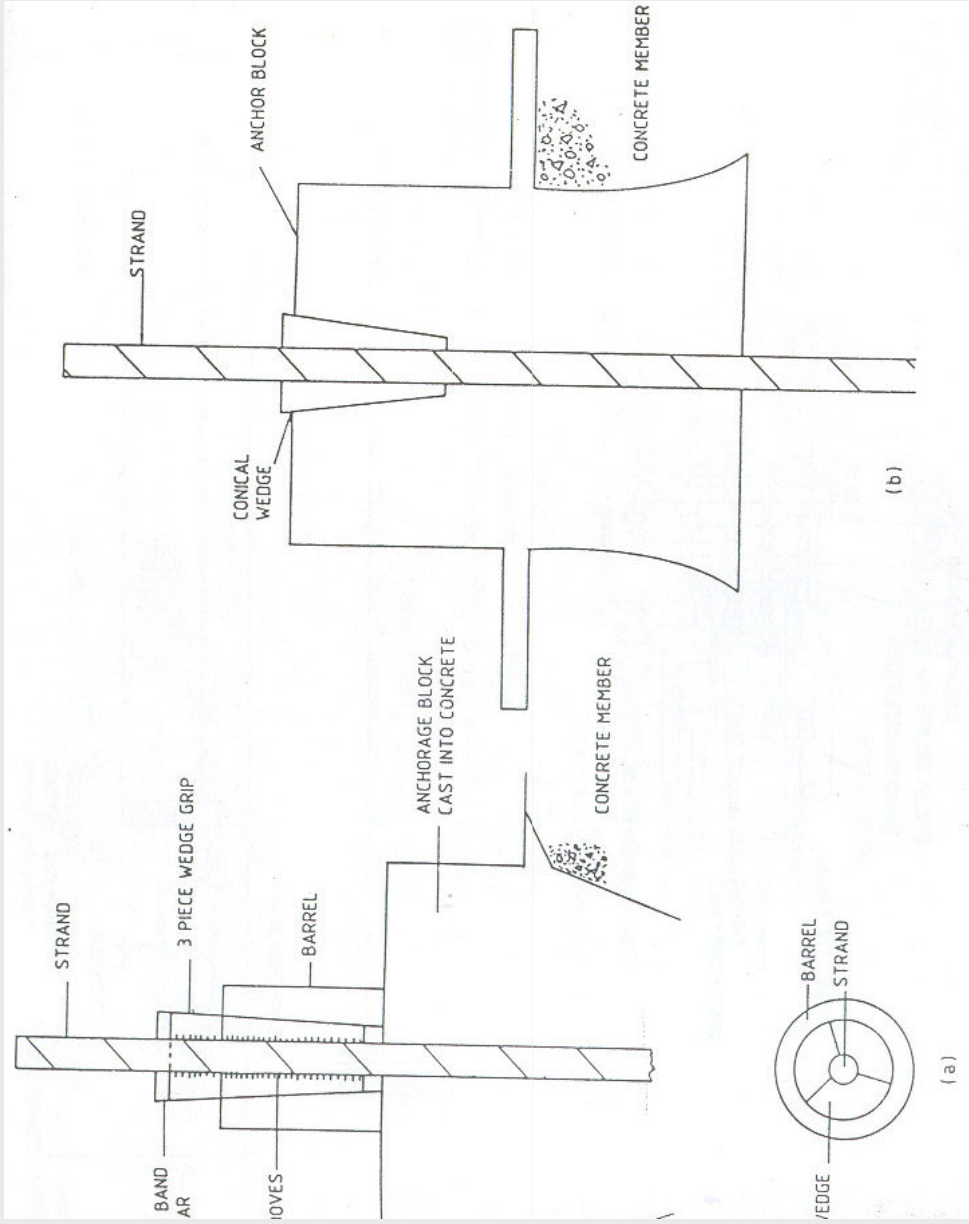
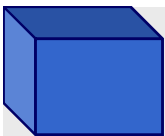

**B. Bhattacharjee**  
DEPARTMENT OF CIVIL ENGINEERING, IIT DELHI



# TENSIONING

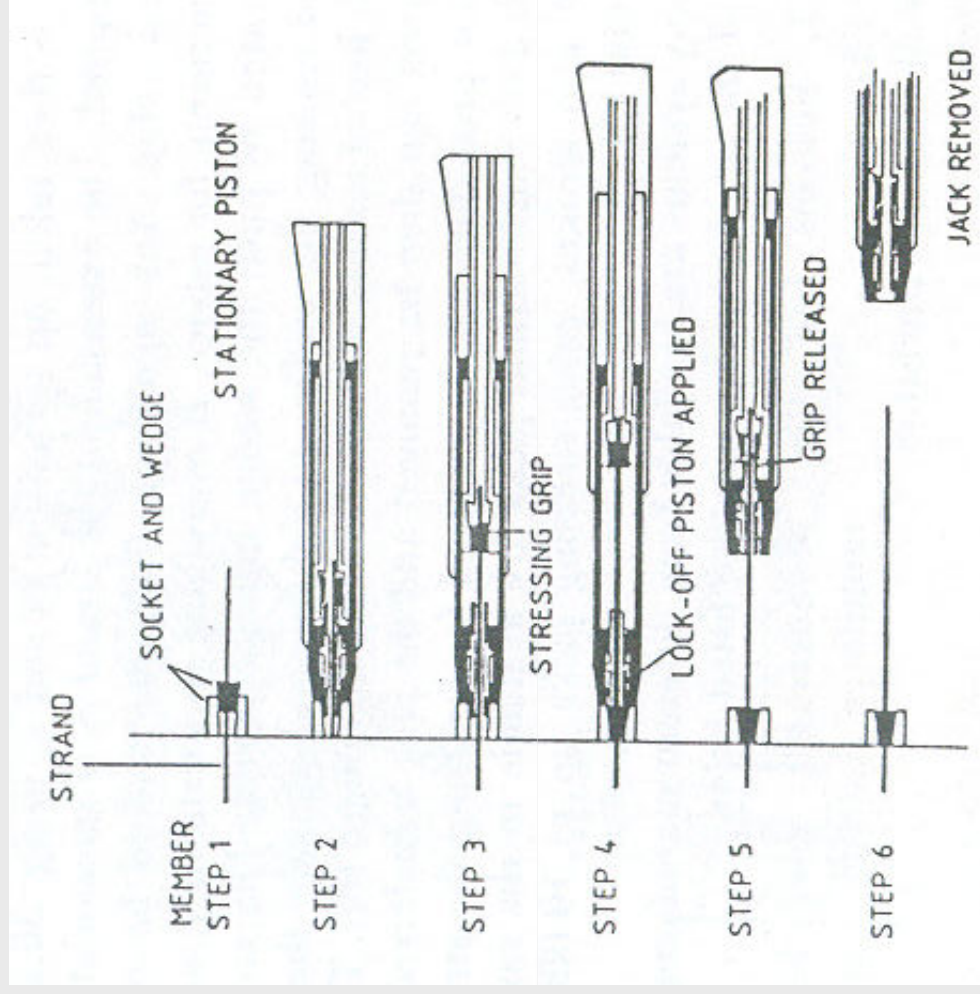

B. Bhattacharjee

DEPARTMENT OF CIVIL ENGINEERING, IIT DELHI

# TENSIONING

## CONCRETE PRODUCTION AND EQUIPMENT

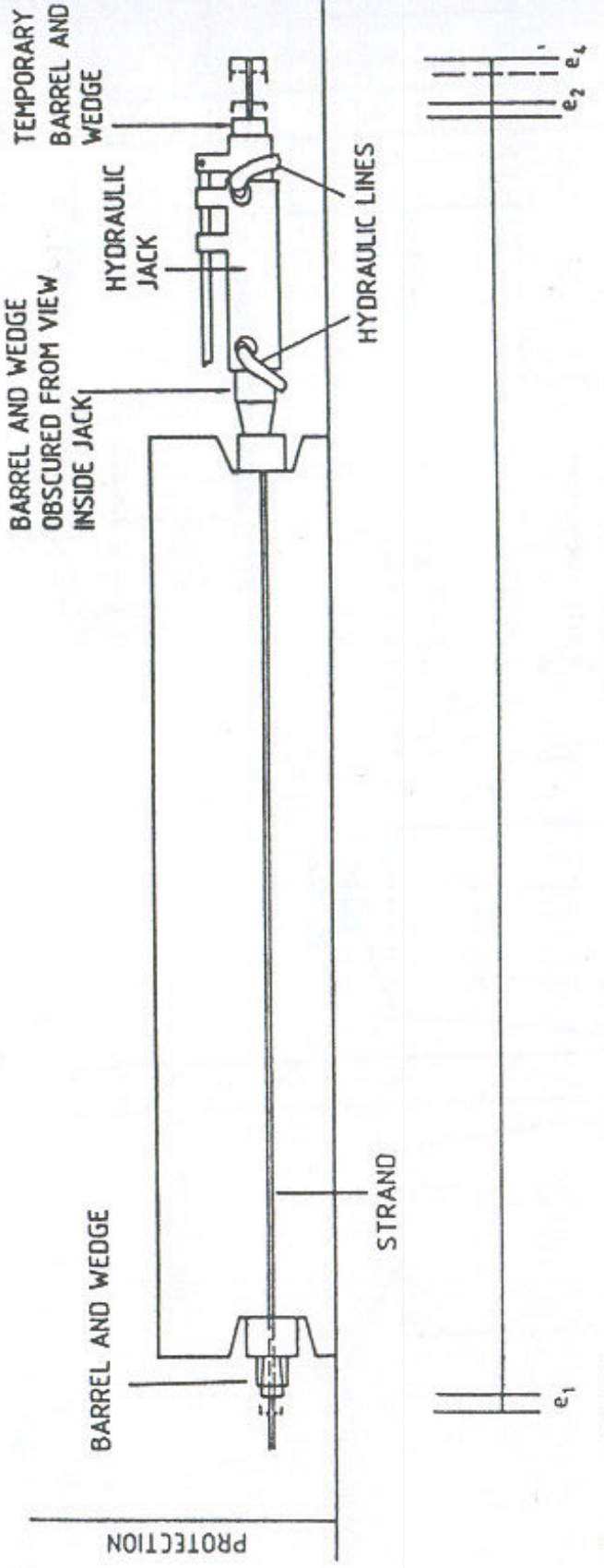

## REQUIRED EXTENSION $e_3$ IS APPLIED THROUGH LOAD



B. Bhattacharjee  
DEPARTMENT OF CIVIL ENGINEERING, IIT DELHI



# SYSTEMS

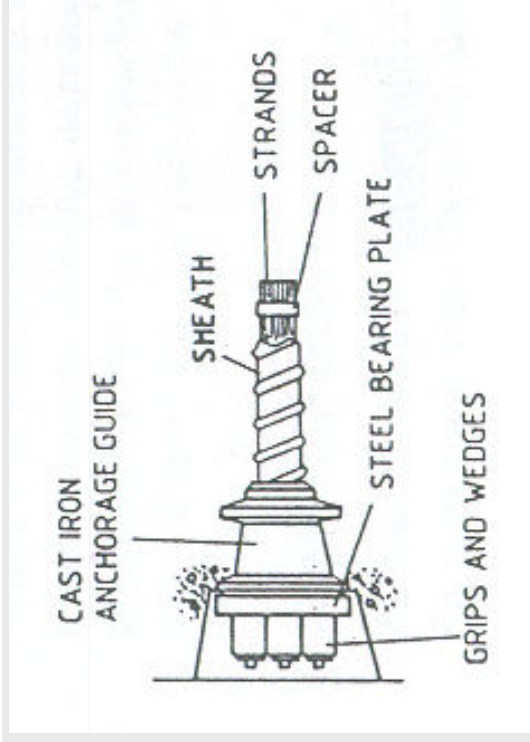
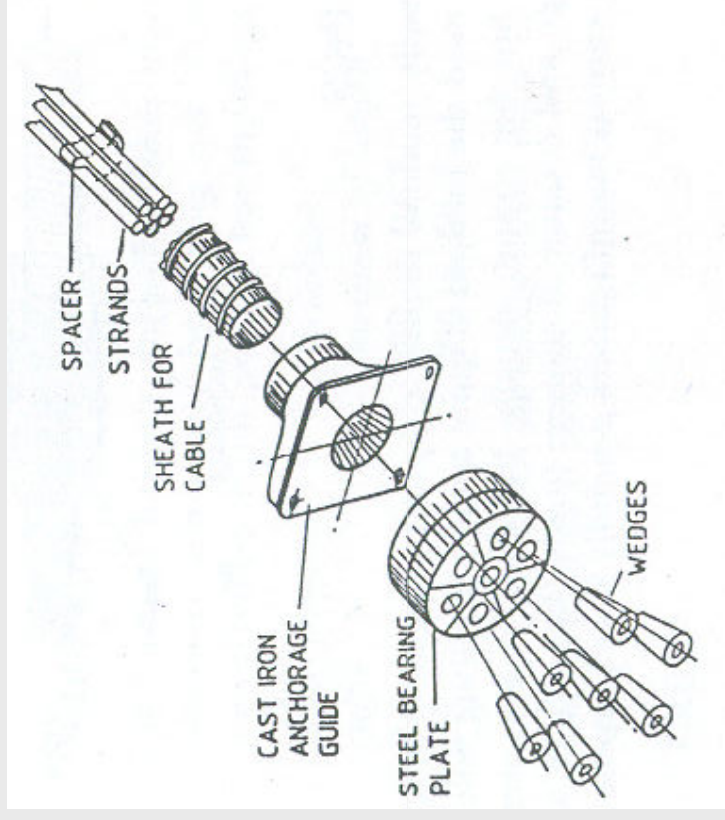
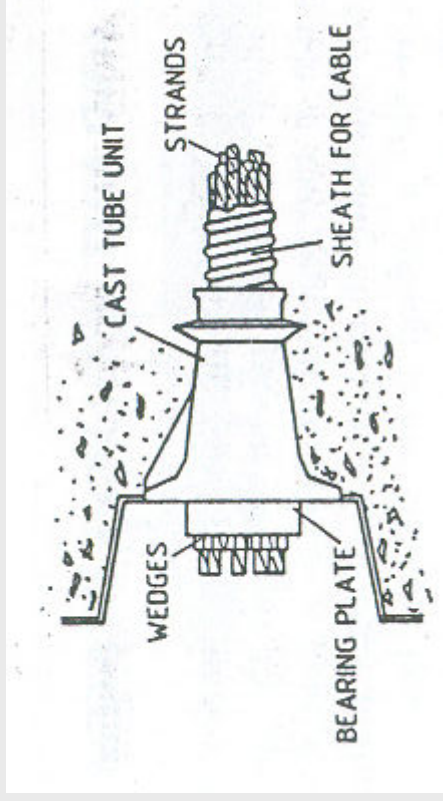

# THREAD & NUT SYSTEMS

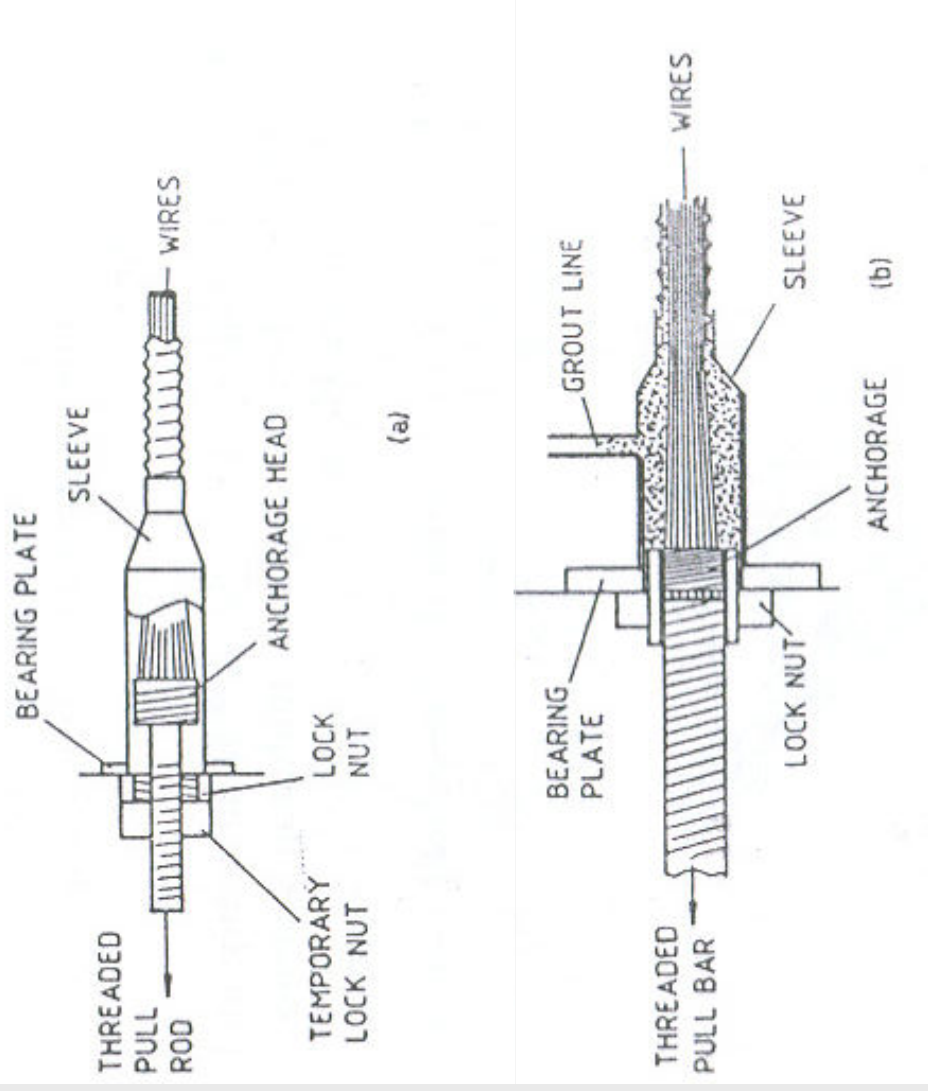

B. Bhattacharjee  
DEPARTMENT OF CIVIL ENGINEERING, IIT DELHI

# COUPLINGS



WEDGES

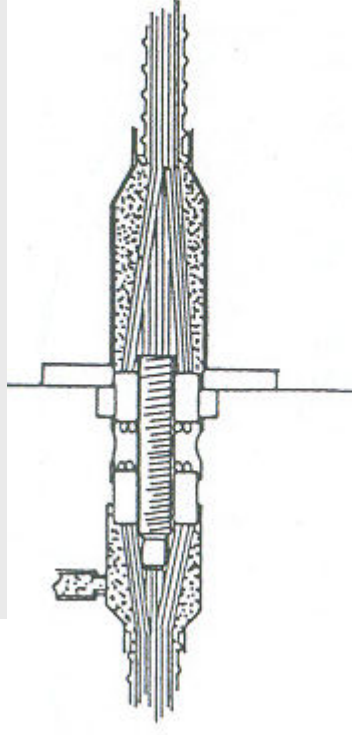
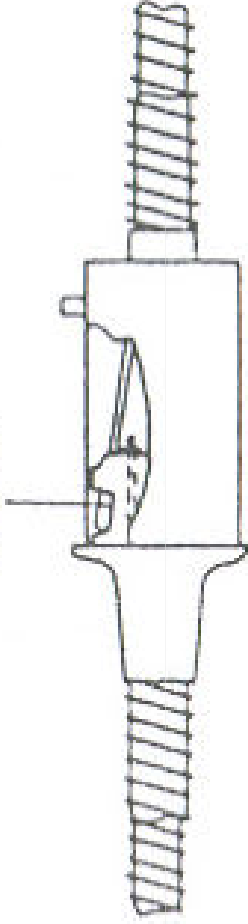

B. Bhattacharjee  
DEPARTMENT OF CIVIL ENGINEERING, IIT DELHI

# LOSS OF PRE-STRESS

- SHRINKAGE OF CONCRETE UP TO 5%.
  - CREEP OF CONCRETE UP TO 10%
  - ELASTIC STRAIN IN CONCRETE UP TO 5%
  - CREEP & RELAXATION IN STEEL UP TO 5%
  - LOSSES DURING TENSIONING & ANCHORING
- TOTAL 20-30 %**



# LOSS & MOVEMENTS

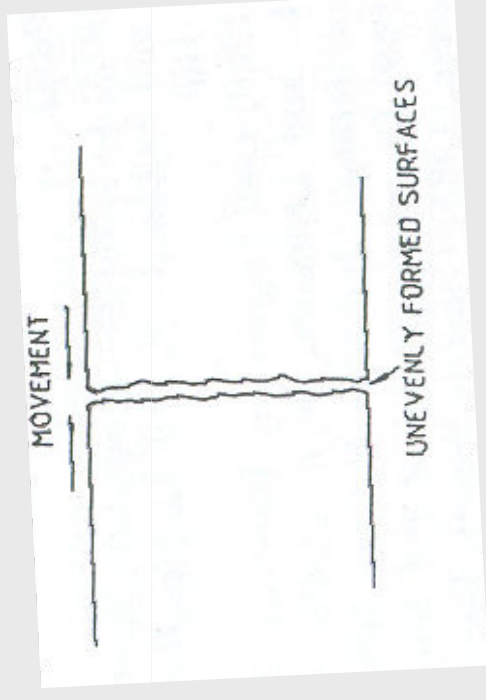
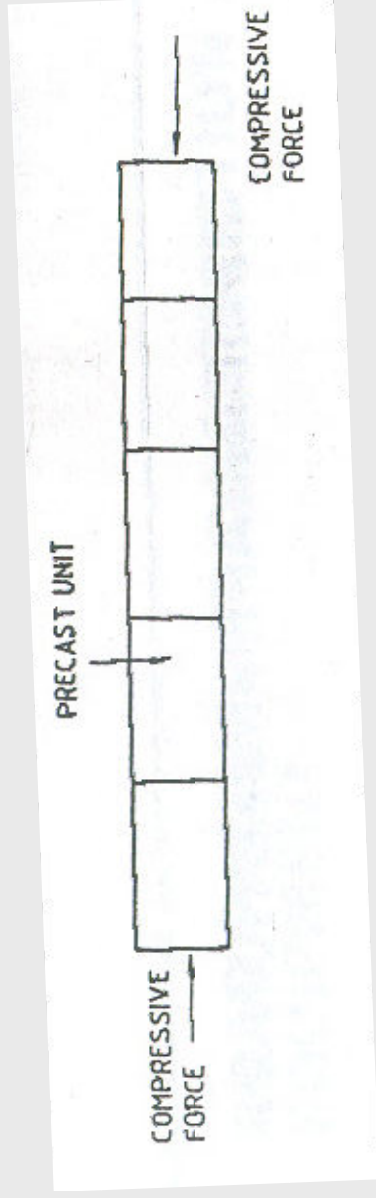

B. Bhattacharjee  
DEPARTMENT OF CIVIL ENGINEERING, IIT DELHI

**THANK YOU FOR  
HEARING**



DEPARTMENT OF CIVIL ENGINEERING, IIT DELHI