



# EPILOG LASER

Fusion M2 32 / 40 Laser System Manual

Model 13000 / 14000



Technical Support: +1 (303) 215-9171

Knowledge Base: [support.epiloglaser.com](http://support.epiloglaser.com)

System Registration: [epiloglaser.com/register](http://epiloglaser.com/register)

Driver/Firmware Download: [epiloglaser.com/tech-support/fusion-drivers.htm](http://epiloglaser.com/tech-support/fusion-drivers.htm)

English



# TABLE OF CONTENTS

<b>Fire Warning</b>	<b>1</b>
<b>Introduction</b>	<b>2</b>
How to Use This Owner's Manual.....	2
Icons Used in this Manual.....	2
<b>Section 1: Safety</b>	<b>3</b>
Laser Safety .....	3
Electrical Safety.....	4
Fire Warning.....	5
Safety Features and Regulatory Compliance .....	6
Do's and Don'ts.....	10
<b>Section 2: Getting Started</b>	<b>11</b>
1. Unpacking the Laser System.....	11
2. Choose Where to Locate the System.....	12
3. Connecting the Exhaust.....	13
4. Connecting Electrical Power.....	15
5. Setting Vector Cutting Table Default.....	15
6. Connect the Laser to Your Computer .....	15
7. Set the Fusion's IP Address.....	16
9. Sign Up for Driver Updates and Register Your System .....	18
<b>Section 3: Driver Installation</b>	<b>19</b>
Windows 7: Ethernet Installation.....	19
Windows 7: USB Installation .....	22
Windows 8 and 10: Ethernet Installation.....	25
Windows 8 and 10: USB Installation .....	28
Setting Up CorelDRAW Beziers Setting .....	31
Mac Driver Installation .....	32
<b>Section 4: The Epilog Job Manager</b>	<b>37</b>
Epilog Job Manager Instructions.....	37
How to Install the Epilog Job Manager.....	37
Trouble Shooting Job Manager Installation.....	39
Important Epilog Job Manager Notes.....	40
Using the Epilog Job Manager .....	40
<b>Section 5: Using The Laser Dashboard™</b>	<b>49</b>
Changing Laser Dashboard Defaults .....	49
General Tab .....	50
Advanced Tab.....	54
Color Mapping Tab.....	56
Additional CorelDRAW Laser Dashboard Features .....	57
<b>Section 6: Using The Epilog Mac Driver</b>	<b>59</b>
Mac Driver Settings.....	59
Project Setup.....	62
Vector Cutting Lines.....	63

# TABLE OF CONTENTS

<b>Section 7: Fusion Control Panel</b>	<b>65</b>
Display .....	65
Joystick.....	74
Job Storage: Temporary Memory.....	75
<b>Section 8: Quick Start Guide</b>	<b>77</b>
Artwork Setup .....	77
Setting a Vector Cutting Line.....	78
Resolution.....	79
Piece and Page Size .....	83
<b>Section 9: Cleaning &amp; Maintenance</b>	<b>85</b>
Reduce Fire Risk with a Clean Laser.....	85
Cleaning the Optics .....	85
Cleaning and Lubricating the Bearing Rails.....	87
Cleaning the Exhaust Plenum.....	88
Laser Tube.....	91
Laser Tube Air Filter .....	91
<b>Section 10: System Features</b>	<b>93</b>
Air Assist.....	93
Auto Focus vs. Manual Focus.....	93
Crash Bar .....	95
Image Dithering.....	96
Color Mapping.....	97
Reset Home Position.....	103
Red Dot Pointer.....	103
Movable Home Position .....	104
Center Engraving.....	105
Emergency Stop Button .....	107
Front Access Door.....	108
Task Plate/Vacuum Hold-Down Table .....	108
Exhaust Plenum .....	109
Safety Interlock / Laser Status Indicators.....	110
Rulers.....	111
<b>Section 11: Optional Features</b>	<b>113</b>
Vector Cutting Table/Vacuum Hold-Down Table .....	113
Pin Table .....	114
Fusion Rim-Drive Rotary Attachment.....	117
3-Jaw Chuck Rotary Attachment .....	125
eView Camera Module.....	135
Dual Source Option .....	146
PhotoLaser Plus.....	148
<b>Section 12: Upgrading the Operational Firmware</b>	<b>155</b>
How to Upgrade Your Firmware .....	155
<b>Section 13: Printing From AutoCAD</b>	<b>159</b>
How to Print from AutoCAD to the Laser.....	159

# TABLE OF CONTENTS

<b>Section 14: Material Engraving Techniques</b>	<b>161</b>
CO2 Laser Materials/Techniques .....	161
3D Engraving .....	161
Acrylic .....	162
Anodized Aluminum .....	163
Brass - Painted .....	164
Glass .....	165
Notary Seals: Delrin .....	166
Plastic Engraving/Cutting .....	167
Rubber Stamps .....	168
Wood .....	172
Fiber Laser Materials/Techniques .....	175
Metal Annealing .....	175
Metal Etching .....	175
Metal Polishing .....	176
Plastic Marking .....	176
<b>Section 15: Specifications</b>	<b>179</b>
Fusion Laser Technical Specifications .....	179
Compatibility .....	180
Recommended PC .....	180
About The CO2 Laser Source .....	181
About the Fiber Laser Source .....	182
Federal Communications Commission (FCC) Notice .....	182
<b>Section 16: Technical Support</b>	<b>183</b>
Contacting Technical Support .....	183
Frequently Asked Questions .....	184
<b>Section 17: Material Suppliers</b>	<b>187</b>
Industry Material Supplier List .....	187
<b>Appendix A: Warranty Statement</b>	<b>191</b>
Warranty Statement for the Fusion Laser .....	191
<b>Appendix B: Material Settings</b>	<b>193</b>
Fusion Series Suggested Material Settings (CO2) .....	193
Fusion Series Suggested Material Settings (Fiber) .....	196
<b>Index</b>	<b>199</b>



# FIRE WARNING



## Fire Warning

Your laser system uses a high intensity beam of light that can generate extremely high temperatures when it comes into contact with the material being engraved, marked or cut. Some materials are extremely flammable and can easily ignite and burst into open flame setting the machine afire. This open flame is very dangerous and has the potential to destroy not only the machine, but the building in which it is housed.

Experience shows that vector cutting with the laser has the most potential to create an open flame. Many materials are susceptible to igniting, but acrylic, in all its different forms, has been shown to be especially flammable when vector cutting with the laser.

Please read the following warnings and recommendations and follow them closely at all times!

- **Stay with the laser.** Never operate the laser system while unattended.
- **Keep the area clear.** Clean around the machine and keep the area free of clutter, combustible materials, explosives, or volatile solvents such as acetone, alcohol, or gasoline.
- **Be prepared with a fire extinguisher.** Always keep a properly maintained and inspected fire extinguisher on hand. Epilog recommends a Halotron fire extinguisher or a multi-purpose dry chemical fire extinguisher. The Halotron extinguishers are more expensive than a dry chemical, but offer certain advantages should you ever need to use an extinguisher. The Halotron extinguisher discharges a clean, easily removable substance that is not harmful to the mechanics or wiring of the laser system. The dry chemical extinguisher discharges a sticky, corrosive powder that is very difficult to clean up.
- **Use Air Assist.** Always use the system's Air Assist feature when vector cutting.
- **Use caution when vector cutting.** Many materials have the potential to suddenly burst into flames when cut with a laser – even materials that may be very familiar to the user. Always monitor the machine when it is operating.
- **Clean the laser.** A buildup of cutting and engraving residue and debris is dangerous and can create a fire hazard in its own right. Keep your laser system clean and free of debris. Regularly remove the Vector Cutting Table to clean any small pieces that have fallen through the grid.

## How to Use This Owner's Manual

Thank you for purchasing an Epilog Fusion Laser system. Your Epilog system has been designed to be easy to operate, but you will utilize it to its fullest potential by taking some time to read this owner's manual prior to use. You will be ready to use the Epilog Laser system as soon as you read the first few sections. Then you can refer to topics in the remaining sections, as you work.

## Icons Used in this Manual

Look for these symbols to help you find valuable information throughout the text:



Helpful notes to keep in mind when running the laser!



This icon signifies advice you can try that will save you significant time.



This icon highlights current contact information for receiving help.



Warnings and cautions to keep in mind when running the laser.



This icon indicates the potential for fire damage when operating the laser.



# SECTION 1: SAFETY

## Laser Safety

The Epilog Model 13000/14000 Laser System is a Class 2 laser product, as defined in International Standard IEC 60825-1.

The Epilog Model 13000/14000 complies with 21 CFR 1040.10 and 1040.11, the Federal Performance Standards for Light-Emitting Products, except for deviations pursuant to Laser Notice No. 50, dated July 16, 2001. The Center for Devices and Radiological Health, of the US FDA, issued Laser Notice No. 50 to permit manufacturers to classify and manufacture their products in accordance with the International Standard.

The output of the embedded laser is fully contained. The laser cabinet has safety interlocks that turn the laser off if any access door is opened during operation, and no special precautions are necessary to operate the laser safely. Access doors are interlocked and can be opened without the use of a tool. Any interlocked door that is opened while the machine is operating will immediately stop the laser from firing.

Access panels are not interlocked and require a tool for opening or removal. Access panels should always be installed when the laser is operating. Never operate the laser system with an access panel removed.

The visible output beam of the Laser Diode Pointer (Red Dot Pointer) is accessible to the operator. While this device employs the same technology as the familiar laser pen-pointers, like them it is potentially hazardous if its beam is directed into the eye.

We have made every effort to make the Laser Diode Pointer (Red Dot Pointer) as safe as possible. Its beam path is located well inside the cabinet, and under normal conditions, no hazardous levels of laser radiation can escape.

**The operator of the Epilog Model 13000/14000 should observe the following general precautions:**

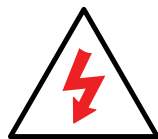

- **DO NOT** disassemble the machine or remove any of its protective covers while the unit is plugged in.
- **DO NOT** attempt to defeat the door interlocks.
- **DO NOT** view directly into the beam of the Laser Diode Pointer (Red Dot Pointer).
- **DO NOT** operate the Laser Diode Pointer (Red Dot Pointer) without the machine's focus lens in place. If the unfocused beam strikes a reflective surface, it could be directed out of the cabinet.
- **Caution** – Use of controls or adjustments or performance of procedures other than those specified herein may result in hazardous radiation exposure.

# SECTION 1: SAFETY

The standard reference for laser safety is the American Standard for the Safe Use of Lasers, Z136.1-2000, developed by the American National Standards Institute (ANSI). This reference is the basis for many of the federal regulations for laser and laser system manufacturers, and for the Occupational Safety and Health Administration (OSHA) laser safety guidelines. It contains detailed information concerning proper installation and use of laser systems.

While the ANSI standard itself does not have the force of law, its recommendations, including warning signage, training, and the designation of a laser safety officer, may be compulsory under local workplace regulations when operating laser systems above Class I. It is the operator's responsibility to ensure that the installation and operation of the Epilog Model 13000/14000 Laser System is performed in accordance with all applicable laws.

Copies of ANSI Standard Z136.1-2000 are available from Epilog Corporation or from:



Laser Institute of America  
12424 Research Parkway, Suite 125  
Orlando, FL 32826  
(407) 380-1553

## Electrical Safety

The AC input power to the Epilog Model 13000/14000 Laser System is potentially lethal and is fully contained within the cabinet.

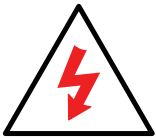

- **DO NOT** open any of the machine's access panels while the unit is plugged in. Opening a panel may expose the operator to the unit's AC input power.
- **DO NOT** make or break any electrical connections to the system while the unit is turned on.



## Fire Warning

**Didn't you see this already? Yes! That's how important we think it is for you to read this information.**

Your laser system uses a high intensity beam of light that can generate extremely high temperatures when it comes into contact with the material being engraved, marked or cut. Some materials are extremely flammable and can easily ignite and burst into open flame setting the machine afire. This open flame is very dangerous and has the potential to destroy not only the machine, but the building in which it is housed.

Experience shows that vector cutting with the laser has the most potential to create an open flame. Many materials are susceptible to igniting, but acrylic, in all its different forms, has been shown to be especially flammable when vector cutting with the laser.

Please read the following warnings and recommendations and follow them closely at all times!

- **Stay with the laser.** Never operate the laser system while unattended.
- **Keep the area clear.** Clean around the machine and keep the area free of clutter, combustible materials, explosives, or volatile solvents such as acetone, alcohol, or gasoline.
- **Be prepared with a fire extinguisher.** Always keep a properly maintained and inspected fire extinguisher on hand. Epilog recommends a Halotron fire extinguisher or a multi-purpose dry chemical fire extinguisher. The Halotron extinguishers are more expensive than a dry chemical, but offer certain advantages should you ever need to use an extinguisher. The Halotron extinguisher discharges a clean, easily removable substance that is not harmful to the mechanics or wiring of the laser system. The dry chemical extinguisher discharges a sticky, corrosive powder that is very difficult to clean up.
- **Use Air Assist.** Always use the system's Air Assist feature when vector cutting.
- **Use caution when vector cutting.** Many materials have the potential to suddenly burst into flames when cut with a laser – even materials that may be very familiar to the user. Always monitor the machine when it is operating.
- **Clean the laser.** A buildup of cutting and engraving residue and debris is dangerous and can create a fire hazard in its own right. Keep your laser system clean and free of debris. Regularly remove the Vector Cutting Table to clean any small pieces that have fallen through the grid.

### Safety Features and Regulatory Compliance

Epilog has incorporated specific safety features into the Model 13000/14000 Laser System in order to meet the requirements of 21 CFR 1040 and the International Standard IEC 60825-1. These safety features include:

- A safety enclosure (cabinet), which fully encloses the engraving laser and its beam path.
- Dual redundant interlock systems that turn off the engraving laser when the window is opened.
- A visible emission indication when the Laser Diode Pointer (Red Dot Pointer) is operating. There is an LED indicator on the machine's front panel.

21 CFR 1040 and IEC 60825-1 require that certification, identification, and warning labels be placed on laser products. Reproductions of labels on the Epilog Model 13000/14000 Laser System follow, with their locations specified:

1. **Certification/Identification Plate:** This engraved plate is located on the left rear of the machine's cabinet.

Epilog Corporation 16371 Table Mountain Pkwy. Golden, CO 80403 USA Model Number: 14000 Laser System Serial Number: 14060- 1512383220 Date of Manufacture: May, 2015	Authorized Representative: cameo Laser Franz Hagemann Gmbh Stuhrbaum14 28816 Stuhr Deutschland Tel: 0421 80 95 60-0 Fax: 0421 80 95 60-25 E-Mail: info@cameolaser.de
<input type="radio"/> <b>Class 2 Laser Product</b>	
This product complies with 21 CFR 1040.10 and 1040.11 except for deviations pursuant to Laser Notice No. 50, dated July 26, 2001.	
This product complies with IEC 60825-1: 2007.	
Mass: 35 kg max	Patents Pending
Made in USA	
	

2. **Warning Logotype:** This label is located on the left rear of the machine's cabinet, above the Certification/Identification plate.



# SECTION 1: SAFETY

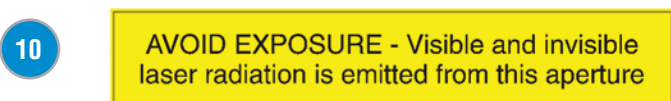
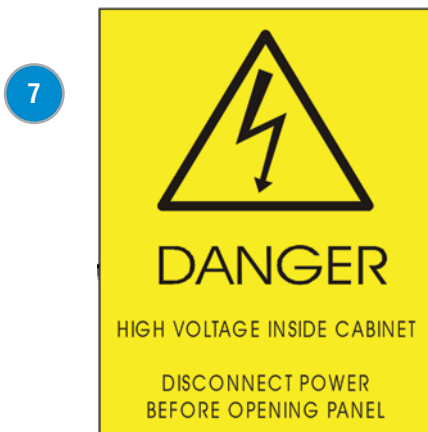

3. **Descriptive Label:** This label identifies the classification of the Model 13000/14000 in accordance with 21 CFR 1040.10 and IEC 60825-1. It is located on the left rear of the machine's cabinet, below the Warning Logotype.
4. **Non-interlocked Protective Housing Safety Labels:** These labels are located on, or adjacent to, removable access covers on the machine's cabinet as shown in the diagrams to follow. Where a label is located on a removable cover, there is an additional label under the cover so that it will be visible when the cover has been removed.
5. **Defeatably-interlocked Protective Housing Safety Labels:** There is one label on each of the machine's cabinet doors; one on the front door and one on the top door.
6. **Emergency Stop Label:** This label is located above the red Emergency Stop switch on the right front of the machine's cabinet.
7. **Electrical Safety Label:** This label is located on the power supply module, inside the bay at the lower right-hand side of the machine.
8. **Main Breaker Label:** This label is located on or below the power module panel at the left rear of the machine's cabinet.
9. **Air Assist Label:** This label is located on the laser bay cover, at the left rear of the machine's cabinet.
10. **Aperture Safety Label:** This label is located above the aperture, inside the cabinet, where laser beams enter the machine's engraving area.
11. **Power Labels:** The appropriate label for the machine is located on or above the power module panel at the left rear of the machine's cabinet.
12. **Fire Warning Label:** There are two labels on top of the machine's cabinet; one to the left and one to the right of the top cabinet door.



# SECTION 1: SAFETY

The following diagrams show the location of each specific label.

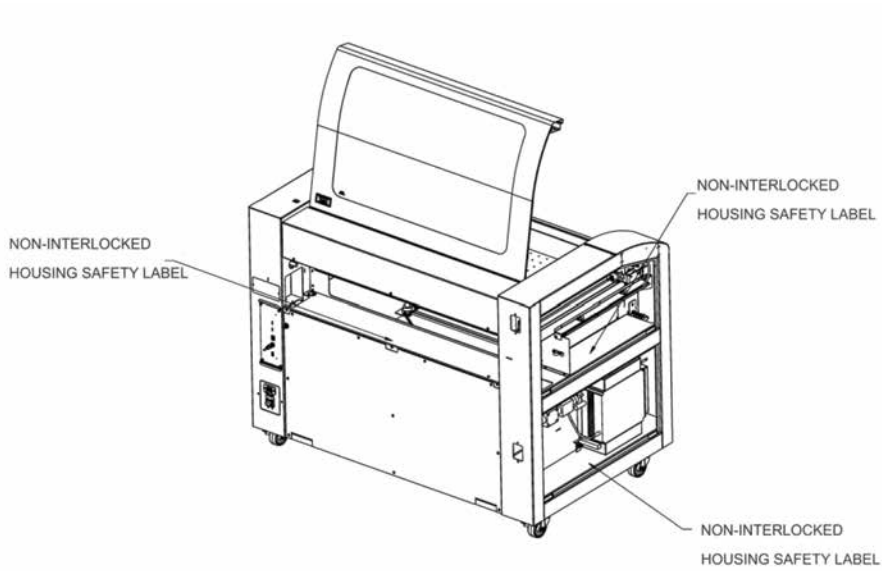
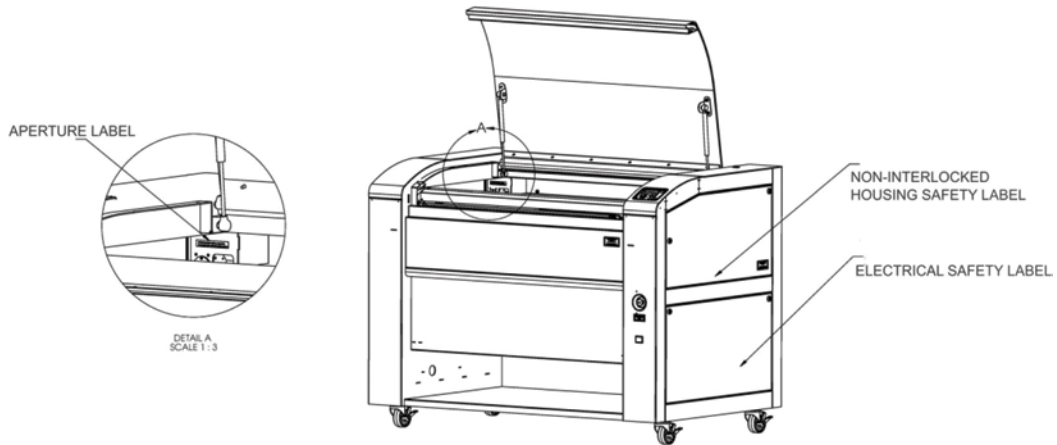

# SECTION 1: SAFETY

## Safety Features and Regulatory Compliance

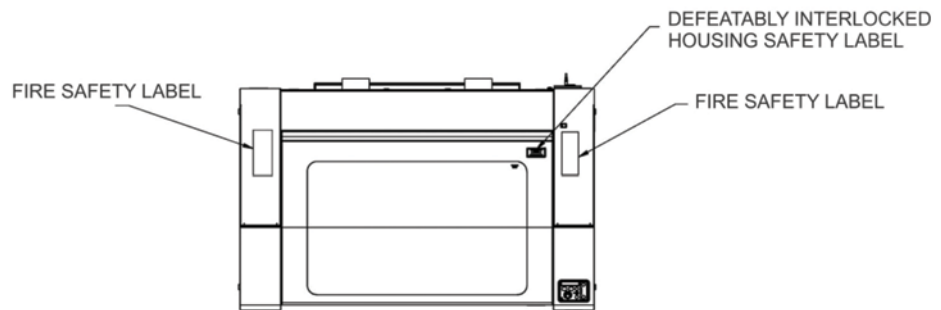
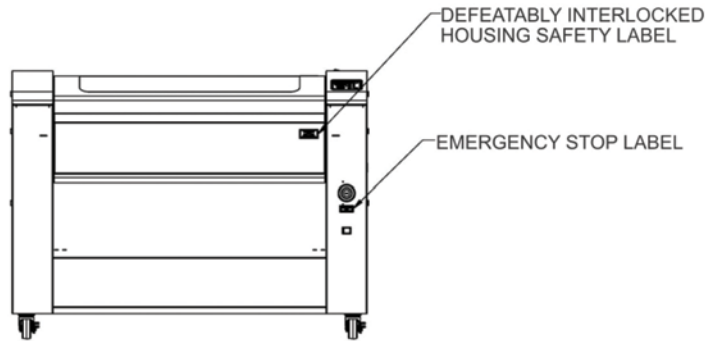
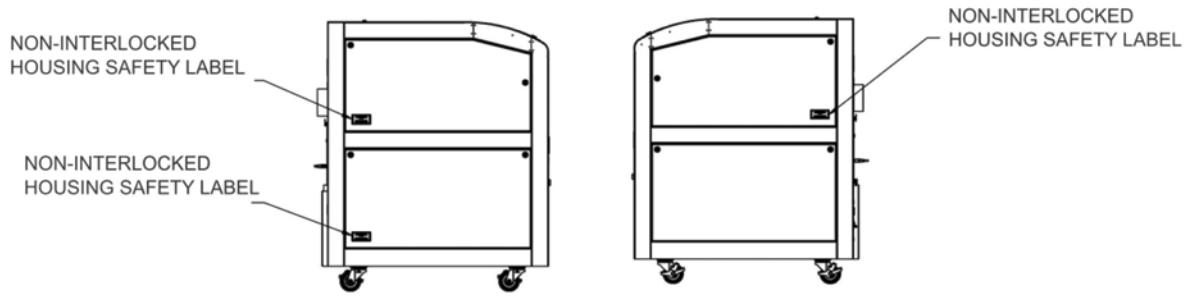
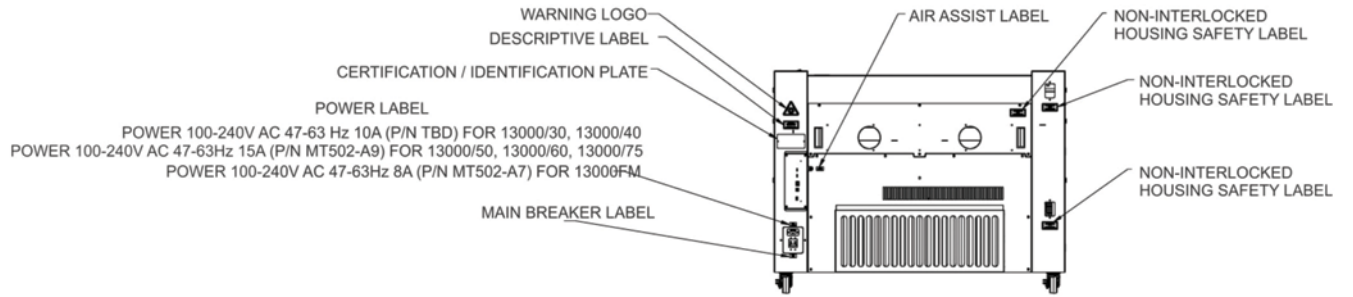

## Do's and Don'ts



### Don'ts

**Do Not Run the Laser Unvented:** Never operate the machine without a properly operating vent to the outside or to a filtration unit! Most material will only produce an irritating smoke when engraved. Some materials, including but not limited to paint, varnish, composition board and plastics, produce compounds that can be harmful if concentrated. A properly installed vent is the only way to ensure that problems do not occur.

**Do Not Engrave or Cut PVC:** Never engrave or cut **any material** containing PVC or vinyl. When engraved, a corrosive agent is produced that will destroy your machine. Your warranty will be void if your machine is damaged by corrosion from engraving or cutting PVC or Vinyl.

**Do Not Operate Machine While Unattended:** Never operate your machine without someone watching the system. There is a significant risk of fire if the machine is set improperly, or if the machine should experience a mechanical or electrical failure while operating.

**Do Not Vector Cut While Machine is Unattended:** Never laser cut any material with the laser without someone watching the system. Because vector cutting moves relatively slowly compared to raster engraving, a tremendous amount of heat is applied to the material being cut. This buildup of heat can cause significant fire risk and the machine should always be monitored. Additionally, the Air Assist should always be turned on when vector cutting to reduce the risk of fire.

**Do Not Operate The System While Doors are Open:** Never operate with any of the covers or enclosures removed, and never modify the enclosure. The laser beam is invisible and is very dangerous!



### Do's

**Clean the System:** Please allow a few minutes a week for cleaning your machine. Just a small amount of effort at the end of the week will pay off with years of trouble free operation of your machine.

See the “**Section : Cleaning & Maintenance**” on page 85 for specifics.



# SECTION 2: GETTING STARTED

## 1. Unpacking the Laser System

Setting up your Epilog Laser System is easy to do! If you've ever installed a paper printer, this is only slightly more difficult. The following information will help you understand the entire system and how it works.

### Your Fusion laser system consists of the following components:

1. Fusion Laser System
2. Epilog Driver Disc
3. USB and Ethernet Cables
4. A Preprogrammed Router (eView Camera Module only)

### You will also need:

1. A computer or laptop.
2. An exhaust fan: The exhaust fan is mandatory and is used to remove smoke and debris from the Fusion work area. The exhaust air can be ported to the outside or into a filter box.

### Follow these steps to setup your Fusion Laser system:

1. Unpack the laser system.
2. Choose where to locate the system.
3. Connect the exhaust system to your laser.
4. Connect the electrical power.
5. Connect the laser to your computer through USB or Ethernet.
6. Sign up for driver update and register your system at [www.epiloglaser.com/register](http://www.epiloglaser.com/register).

## 1. Unpacking the Laser System



Unpack the laser system from the crate provided by Epilog. **Please be sure to hold on to all packing materials and crating in case you need to move the system in the future.**

## 2. Choose Where to Locate the System

### Cooling Requirements and Operating Temperatures

All Epilog Laser systems use air-cooled laser tubes. Laser technology is such that the laser tubes generate a lot of excess heat and the tubes must be cooled for proper operation. There are cooling fans located at the back of the laser. The fans and vents should always be clear of restrictions and should never be covered.

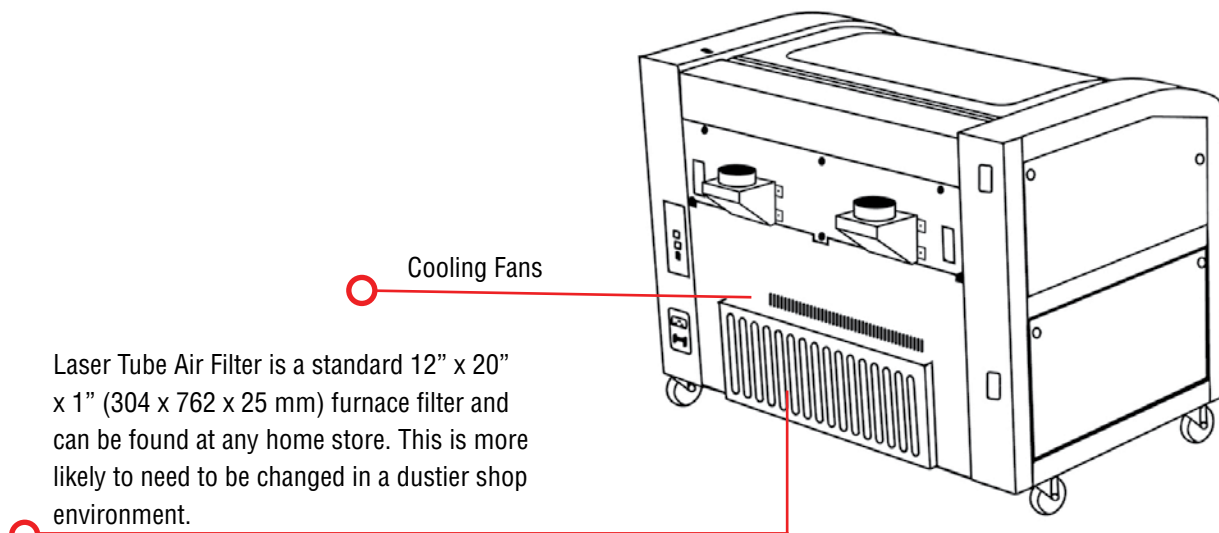

**Warning:** The cooling fans and vents are located at the back of the Fusion and should never be covered or blocked in any way. Lasers that overheat will not operate properly and may begin to produce erratic laser output or possibly complete failure.

Ambient air temperature where the laser system is operating should not exceed 90 degrees F (32 C). Operating in an environment where the ambient air temperature is above 90 degrees F (32 C) will void the Epilog warranty.

### 3. Connecting the Exhaust

In this manual, the term “exhaust” refers to either an exhaust fan or a filter unit and the term “exhaust” is used for simplicity. The important point is that it is mandatory that an exhaust unit or filter system is incorporated as part of your laser system. Never operate your laser system without a properly functioning exhaust. The exhaust removes the dust, debris and smell from the engraving cavity and exhausts it to the outside of the building or to the filter unit. Prior to the installation of the laser system, you may need a contractor to install the exhaust system. The blower should be mounted outside your building for noise considerations. Ideally, the blower should not be more than twenty feet (6 meters) from the laser. You should provide a metal duct (flexible aluminum or galvanized sheet metal) from the blower to the laser. All Epilog model 13000/14000 laser systems require an exhaust fan that is rated at a minimum of 650 CFM for external exhaust.

Epilog provides recommended exhaust flow rates (CFM) only for direct ventilation exhaust systems that are ported to the outside. Please note that this is also a recommendation and not a requirement because factors such as length and type of tubing from the Epilog laser to the exhaust fan and from the exhaust fan to the outside of the building can produce significant losses on the true amount of air that is drawn from the Epilog laser.

Exhaust flow rates (CFM) for filter systems are not specified in this document. However, exhaust flow rates for filtration units will be lower than a direct ventilation exhaust systems because filters are designed to be placed directly adjacent to the laser system and do not exhibit the air-flow losses that are typically found with direct exhaust fans. Epilog has worked with most major filter manufacturers to recommend a specific filter system for each model of Epilog laser. Please contact your Epilog distributor to match a filter to the Epilog laser system you are using.



**Note:** Remember to put the blower switch for the laser system in an obvious and accessible place so it can be routinely switched on prior to using the engraver. Please connect the exhaust blower to the laser as shown below and on the following pages.

Remember, you may need a contractor to install the exhaust. This must be done PRIOR to installation of the laser system.



**Warning:** It's important that either rigid or flexible metal ducting be used for all connections leading to and from the laser system and the exhaust fan. Vinyl, plastic, or any type of “soft” ducting is potentially flammable and should not be used unless provided by the filtration system manufacturer and made from fire-proof materials.

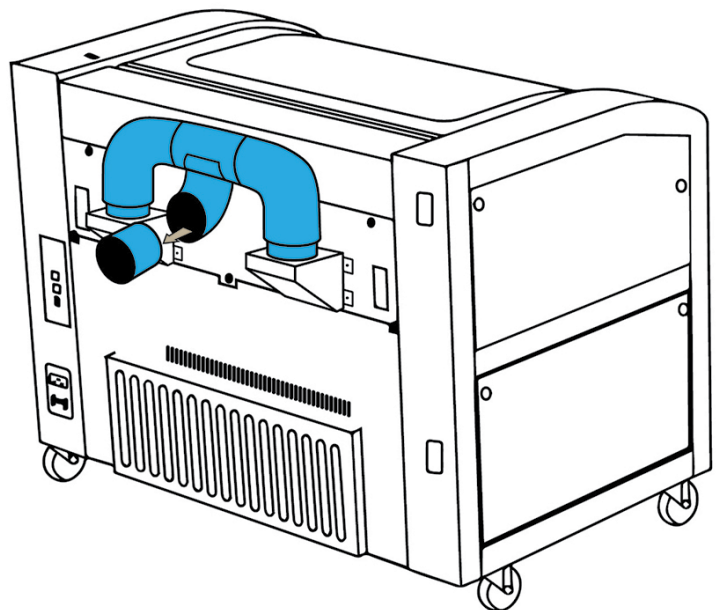

## SECTION 2: GETTING STARTED

### 3. Connecting the Exhaust

#### Epilog Exhaust/Filter Connections

There are two 4" (102 mm) ports attached to the back of the laser system. Attach your ducting to the machine as shown

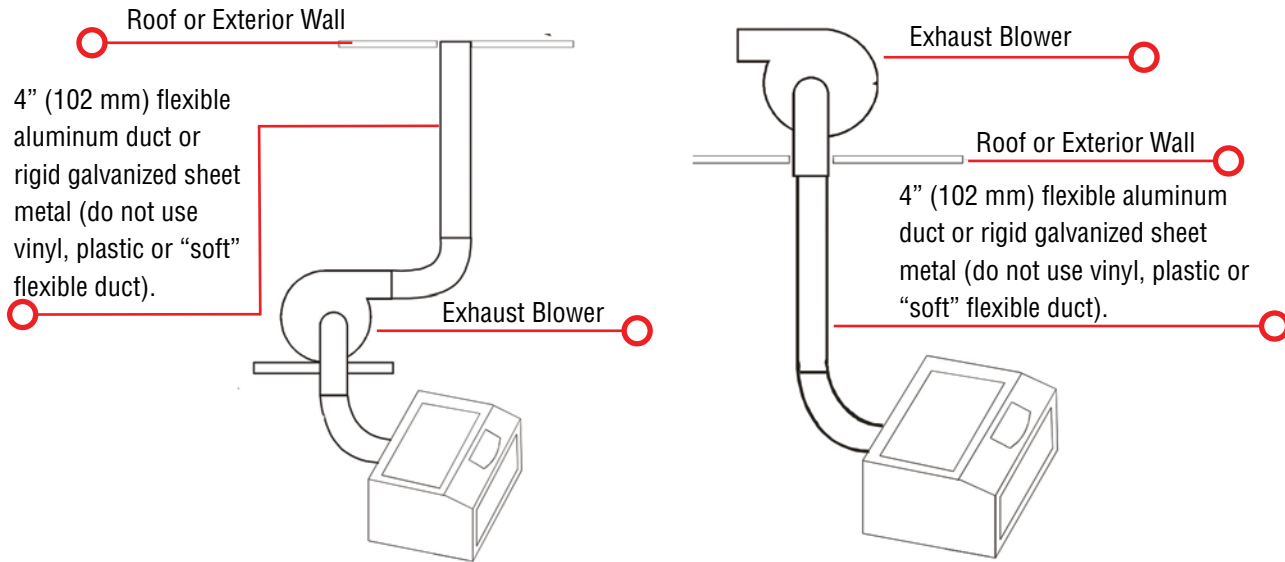

in the diagram.



Check your exhaust system for leaks. Most small leaks can be remedied with duct tape. **DO NOT OPERATE** your laser with inadequate or leaking exhaust.

## SECTION 2: GETTING STARTED

### 4. Connecting Electrical Power

The drawings below show the typical exhaust setup. The left drawing shows the exhaust near the machine and the right drawing shows the exhaust fan on the roof. Where the exhaust fan is placed is a choice of personal preference. Some users like the exhaust fan outside because of noise considerations.

## 4. Connecting Electrical Power

All Epilog laser systems have an auto-switching power supply that detects the incoming voltage and automatically switches itself to operate properly at any single phase voltage between 100 and 240 VAC. The power supply will also automatically compensate for either 50 or 60 Hz. Epilog supplies the appropriate power cord for the system you ordered. The power cord is found in the accessory package with your machine. The power cord for the laser plugs into the power receptacle located on the left side of the machine in the rear corner. It is recommended that a dedicated 15 amp circuit be used if available, but it is not required.

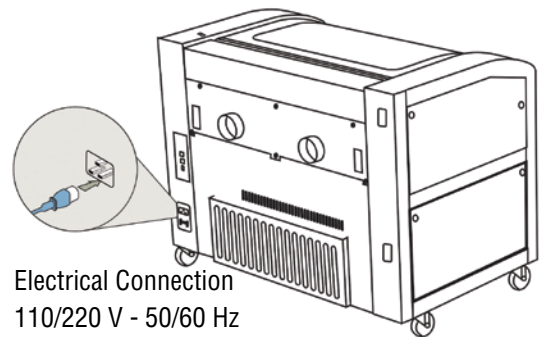

Electrical Connection  
110/220 V - 50/60 Hz

The Fusion 120 watt laser system requires 208/220/240 volt electrical power. This system will not operate on 120 volt power. The Fusion 120 watt power cord comes with a male plug type NEMA L6-15R (which is a Hubble HBL4570C equivalent).

While the 60 and 75 watt Fusion models can operate on 110 volts, we recommended using 208/220/240 volt electrical power to achieve maximum performance. If you would like a 220V cord for your 60 or 75Watt Fusion, please request it at time of ordering.

## 5. Setting Vector Cutting Table Default

If you have ordered the optional Vector Cutting Table, install it into your system (see “**Installation of the Vector Cutting Table**” on page 113). On the Fusion Control Panel, use the **Joystick** to scroll down until **Settings** is highlighted. Use the **Joystick** to scroll through the options until you see **Vector Grid In**. This indicates if the Vector Cutting Table is installed. **Center click** to gain access, **tilt** the Joystick up or down to toggle to **Yes** if the Vector Cutting Table is installed. Press the **Go** key to make your change permanent.

## 6. Connect the Laser to Your Computer

You are now ready to connect your computer to the laser. The following connections can be used:

1. **USB only connection:** You can use the USB port for the print driver and Epilog Job Manager. Multiple laser systems cannot be operated from a single computer through the USB connections. If you are using the USB connection, you

## SECTION 2: GETTING STARTED

### 7. Set the Fusion's IP Address

will need one computer for each laser system.

2. **Ethernet only connection:** With an Ethernet connection you can print from the Laser Dashboard and use the Epilog Job Manager.
3. If you are using the optional eView Camera Module, you will need to use both USB and Ethernet connection. For this connection, please see “**Attaching the eView Camera System to Your Computer**” on page 135.

## USB Connection

A USB cable is included in the accessory kit. The USB port is located at the rear of the machine. USB cables have different connectors on each end. **Before plugging in the USB cable, turn the laser OFF**, then connect one end to the laser and connect the other end into any available USB port on your computer. **After** connecting the USB cable, turn the laser back on.

The computer will recognize a new USB device and walk you through the print driver installation. For detailed instructions, see “**Windows 8 and 10: USB Installation**” on page 28.

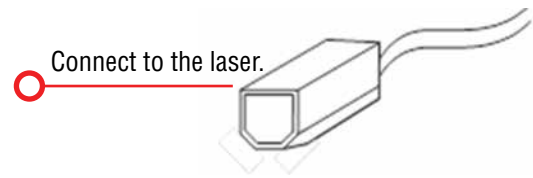

## Ethernet Connection

The Ethernet Port is a standard 10BaseT connection. Your Epilog Laser has all of the versatility of a network capable peripheral. As such, there are many different ways that the laser can be connected to a computer or a network. A direct connection using a crossover cable is the only method that will be described in this manual. Connect the crossover cable (included in the accessories kit) to the Ethernet port, located at the back of the machine. Plug the cable into the Ethernet port on the laser, then plug the other end into the Ethernet port on your computer.

The Epilog Dashboard is the print driver that allows your computer to talk to your Epilog Laser system when either the USB or Ethernet Crossover cables are connected. The driver is included in the accessories kit on a CD-ROM or on our website at [www.epiloglaser.com](http://www.epiloglaser.com). To see detailed instructions on installing the print driver, see “**Windows 8 and 10: Ethernet Installation**” on page 25.

## 7. Set the Fusion's IP Address

1. To set the IP Address from the Fusion's control panel, press the down arrow until **Settings/Config** is selected. It'll vary depending if you have the symbolic or text keypad.
2. Tilt the joystick down until IP Address appears.
3. **Center click** to gain access, **tilt the Joystick** up or down to increment or decrement. **Tilt left or right** to move to the different sets of three numbers. Press the **Go** key to make your change permanent.

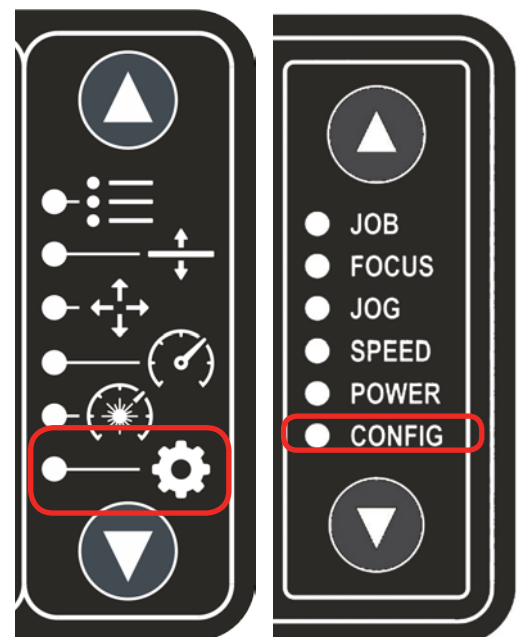

## SECTION 2: GETTING STARTED

7. Set the Fusion's IP Address

Most Epilog users will use the IP Address of 192.168.003.004, which is what we use in this manual.



IP Address  
192.168.003.004

4. With CONFIG still selected, tilt the Joystick down until **Subnet Mask** appears.
5. **Center click** to gain access, **tilt the Joystick** up or down to increment or decrement. **Tilt left or right** to move to the different sets of three numbers. Set the Subnet Mask to 255.255.255.0. Press the **Go** key to make your change permanent.

Subnet Mask  
255.255.255.0

## 8. Set Up TCP/IP Address in the Computer

Go to your Network and Sharing Center in your computer's Control Panel.

1. Click **Change Adapter Settings**.

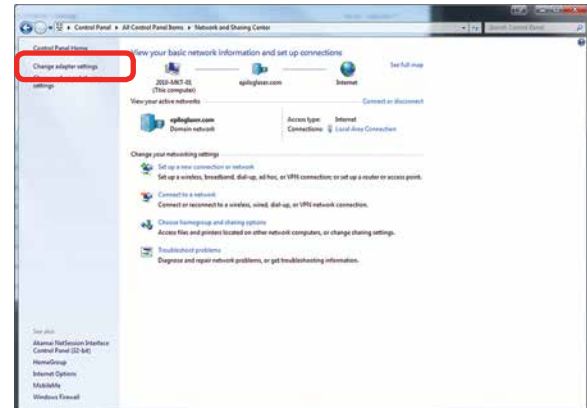

2. Right click **Local Area Connection**, then click **Properties**.

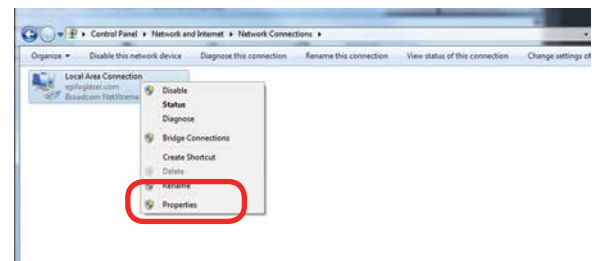

3. Select **Internet Protocol Version 4 (TCP/IP)**. Make sure you do not select Version 6.

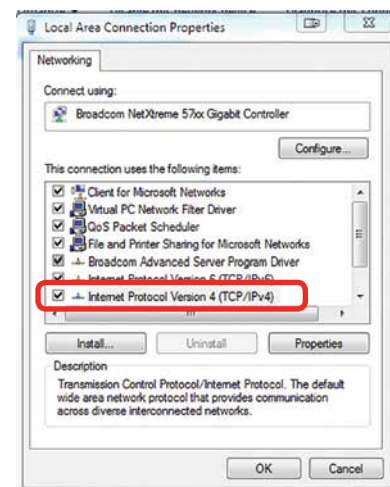

## SECTION 2: GETTING STARTED

### 9. Sign Up for Driver Updates and Register Your System

4. **If you do not have an eView Camera Module installed**, select **Use the following IP Address**. Type in the following IP Address: **192.168.3.3**.



This number is not an error; the last digit of the IP address in **this window must be different than the IP address you set in the laser**.

Type in a Subnet Mask of **255.255.255.0**, then click **OK**.

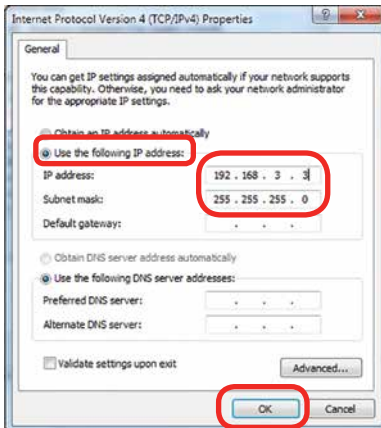

5. **If you do have an eView Camera Module installed**, choose **Obtain an IP address automatically**. Then click the **OK** key.

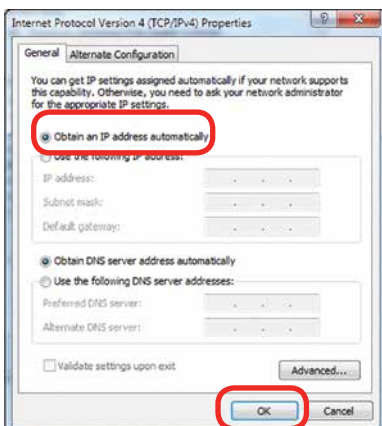

## 9. Sign Up for Driver Updates and Register Your System

Go to [www.epiloglaser.com/register](http://www.epiloglaser.com/register) and register your system. You can also sign up for our monthly e-newsletter, quarterly customer printed newsletter, and sign up for driver update notifications.



# SECTION 3: DRIVER INSTALLATION

Next we'll be installing the print driver. Choose your operating system. We demonstrate Windows 7, 8, and 10 installations.

## Windows 7: Ethernet Installation

1. Insert the Driver CD in the computer and select your laser system.



2. Select the Dashboard Driver.

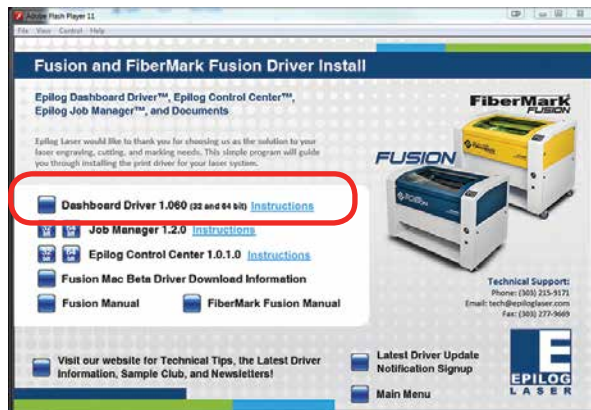

You can also download the latest driver from [epiloglaser.com/tech-support/epilog-drivers.htm](http://epiloglaser.com/tech-support/epilog-drivers.htm). Go to **Devices and Printers** on your computer and click **Add a Printer** to start the process.

3. Click **Add a local printer**.

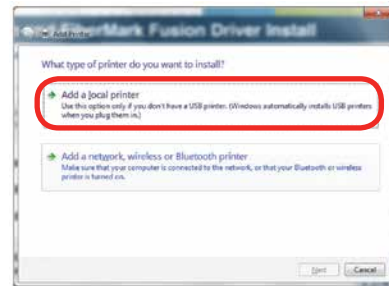

4. Click **Create New Port**, then click on the drop-down menu and select **Standard TCP/IP Port**, then click **Next**.

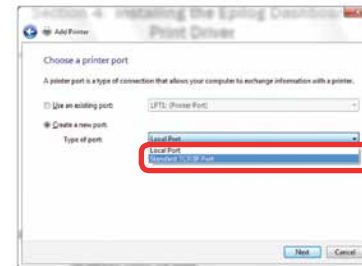

5. Enter the IP Address to match the IP Address you set at the Fusion laser in "**Setting the IP Address**" on page 16. Most Epilog users will use the IP Address of 192.168.3.4, which is what we use in this document. After typing in the IP Address, click **Next**. Wait while the computer identifies the port.

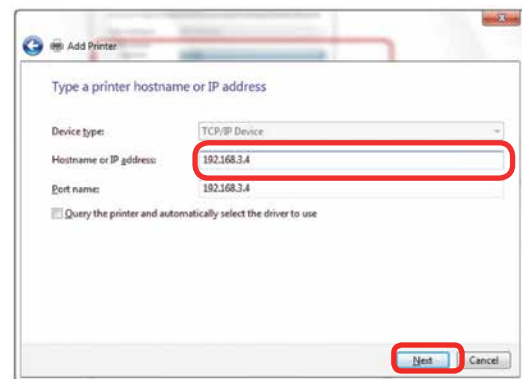

# SECTION 3: DRIVER INSTALLATION

6. Select **Custom** and then **Settings**.

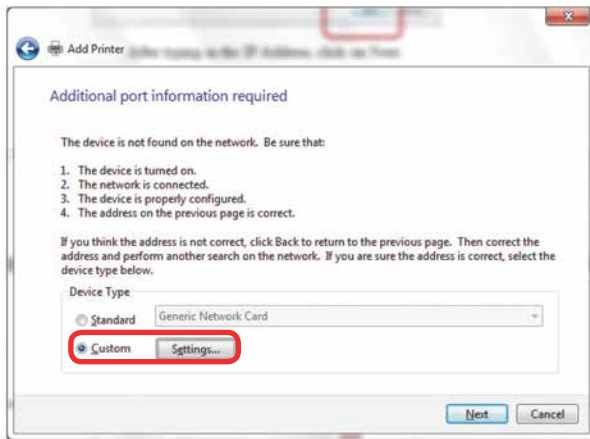

7. **Set Protocol to LPR.** This is a very important step. Your download time will increase significantly if LPR is not selected. Type **Laser** into the Queue Name, then click **OK**.

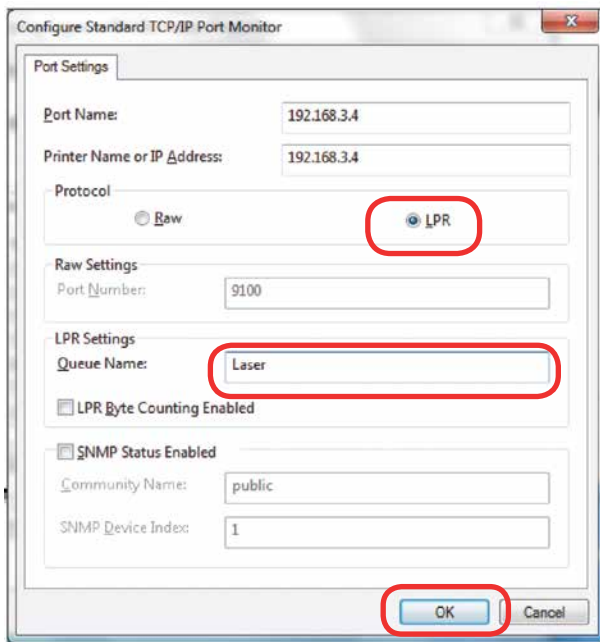

8. Click **Next**.

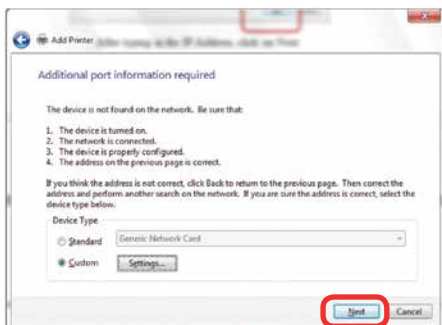

9. Click **Have Disk**.

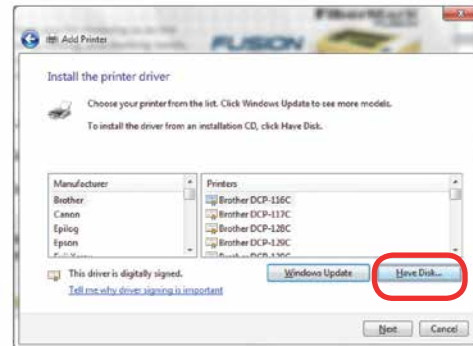

10. Click **Browse** and go to the folder where you saved the driver and click **Open**. (The default location is C:/fusion\_drivers.)

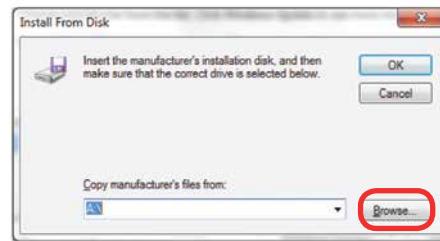

11. Click **EpilogWinALLFusion** file and click **Open**.

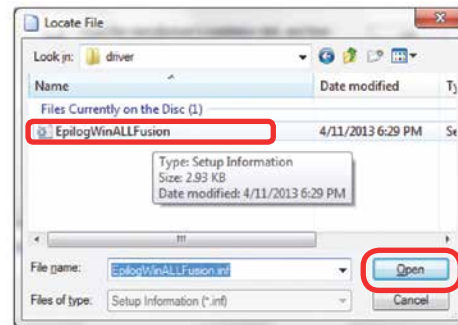

12. Click **OK**.



# SECTION 3: DRIVER INSTALLATION

13. Click **Next**.

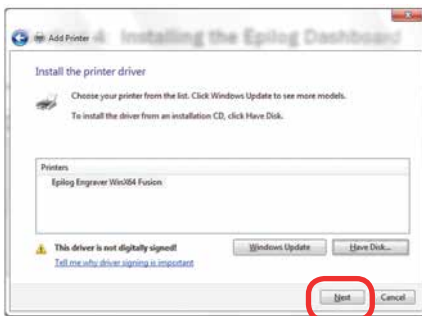

14. Click **Replace the current driver** if requested, then click **Next**.

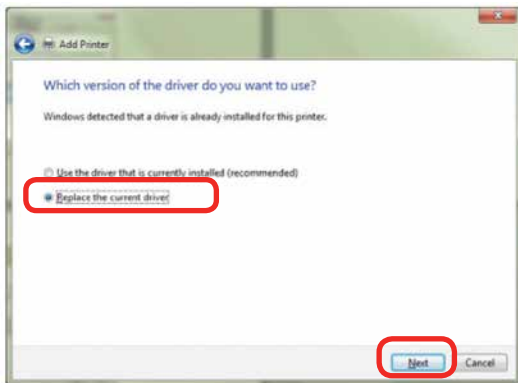

15. You can rename your printer here. We have not changed it for this document, but many users like to associate the driver name with the IP Address they are using, for example Fusion 192.168.3.4. This is especially helpful if there is more than one laser connected to a single computer. Click **Next**.

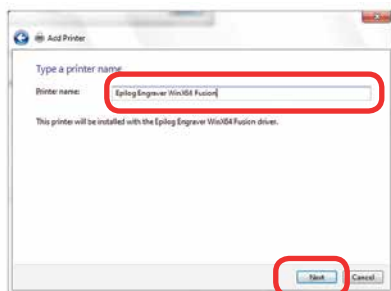

16. If you see this screen, click **Install**.

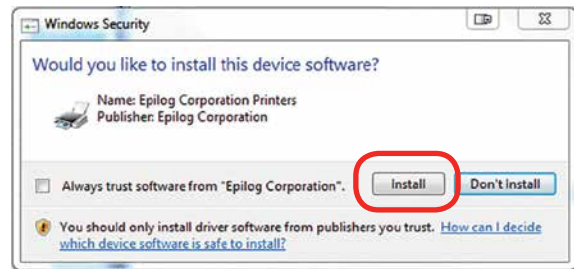

17. Click **Next**.

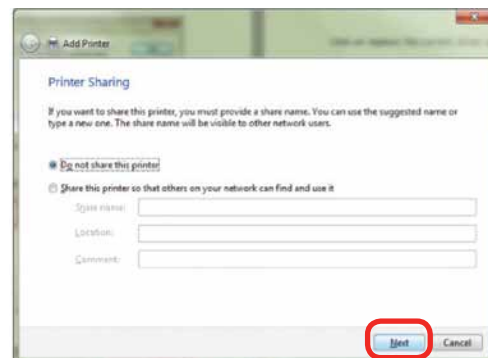

18. Click **Finish** and your driver is installed.

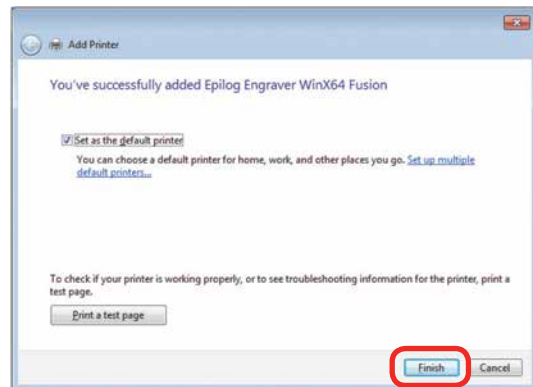

19. **You must now restart your computer** before you continue.

20. If you will be printing from CoreIDRAW, go to **“Setting Up CoreIDRAW Beziers Setting”** on page 31.

# SECTION 3: DRIVER INSTALLATION

## Windows 7: USB Installation

Please follow these instructions closely! Using a different process to install the Dashboard driver is likely to fail if you are using Windows 7.

1. Insert the Epilog driver install disc into your computer (or download the files from the website). One of the following screens will appear. For the USB installation, you will want to close them. We do not want the computer to automatically try to install the driver.

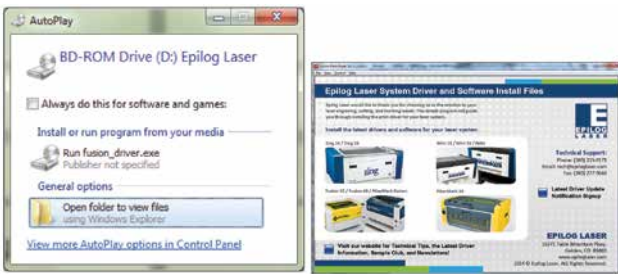

2. With the power of your laser turned off, **connect the USB cable** to your computer and your Fusion.
3. **Power on your laser system.** It will take about a minute for the laser to initialize. After it initializes it will start the process of installing the driver. You will see activity on the USB icon in your system tray (lower right corner of your computer screen).



4. A small window will appear in the lower right corner of your computer screen that indicates installation was successful. This is only partially true.
5. After a short wait you will see another small window

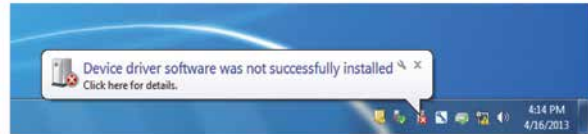

that indicates the installation was not successful. This is what we hope to see and will lead us to the next step in the process. If your computer is connected to the Internet, it will take a few minutes for your computer to display these windows. Please be patient during this process and let the computer finish trying to install the drivers. Interrupting the computer at this point will require you to restart the process.

6. After the failure notification, go to the Windows start key (lower left corner of your computer screen). Click **Devices and Printers**.

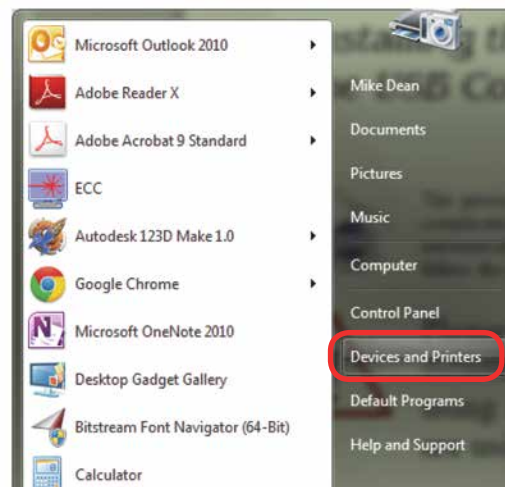

# SECTION 3: DRIVER INSTALLATION

7. Right click on the **Fusion, Zing, Mini/Helix, or FiberMark icon**. Then click **Properties**.

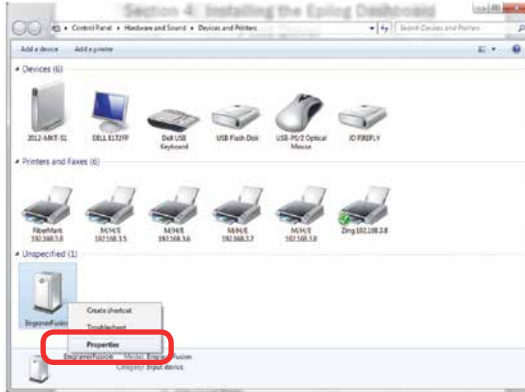

8. Select the **Hardware** tab.

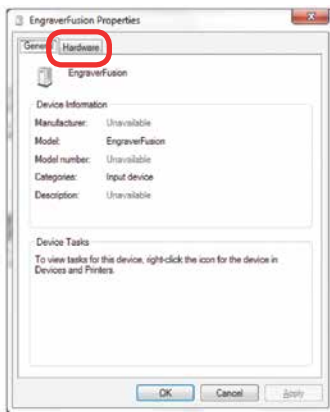

9. Select the device **EpilogEngraver** then click **Properties**.

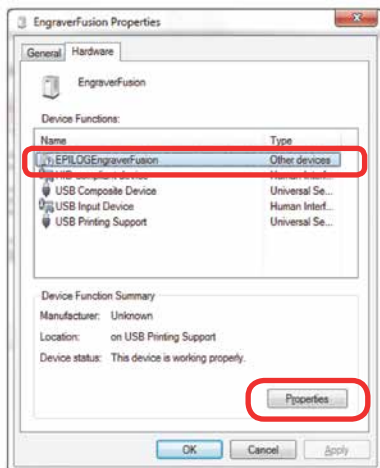

10. Click **Change Settings**.

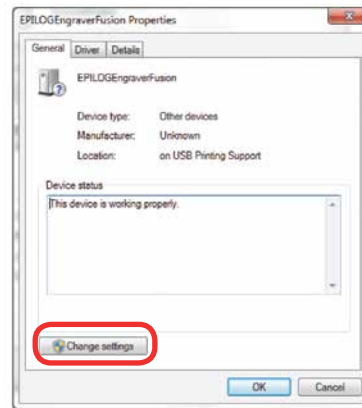

11. Click the **Driver** tab.

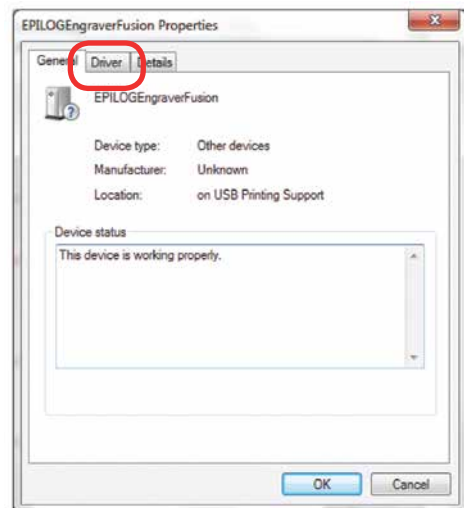

12. Click **Update Driver**.

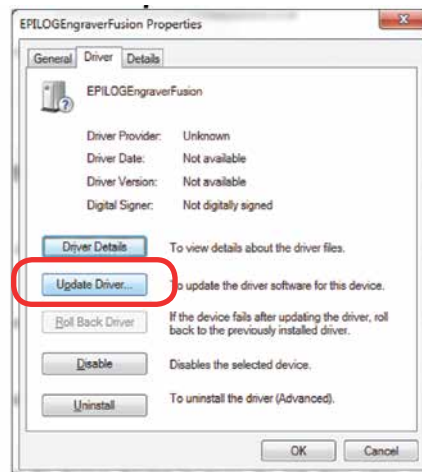

# SECTION 3: DRIVER INSTALLATION

13. Click **Browse my Computer for driver software**.

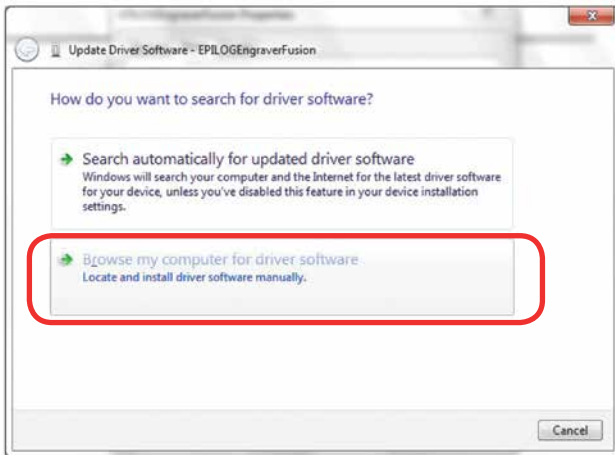

14. Use the **Browse** key to direct your computer to your disc drive that contains the Epilog driver disc that you inserted earlier in this process. (You can also download the latest driver from [epiloglaser.com/tech-support/epilog-drivers.htm](http://epiloglaser.com/tech-support/epilog-drivers.htm).)

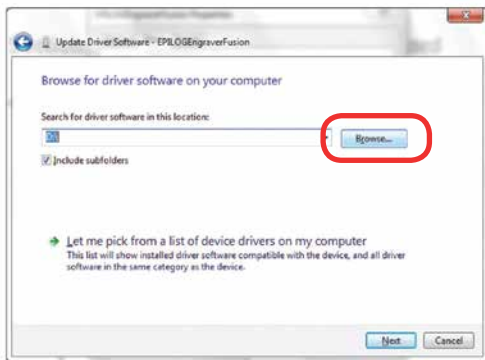

15. For this document we show the DVD RW drive as the drive where the disc is located.

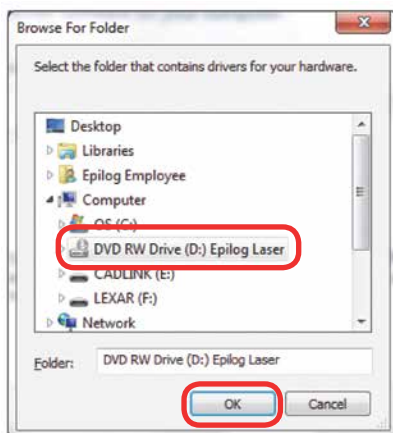

16. Once you have the proper disc drive showing click on the **Next** key.



17. The progress window will appear.

18. If you see this screen, click **Install**.

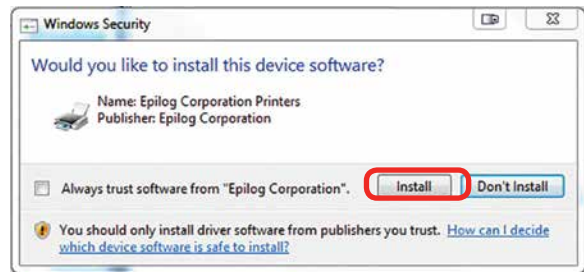

19. Your Epilog Laser Dashboard print driver has been successfully installed on the USB port. Click **Close**.

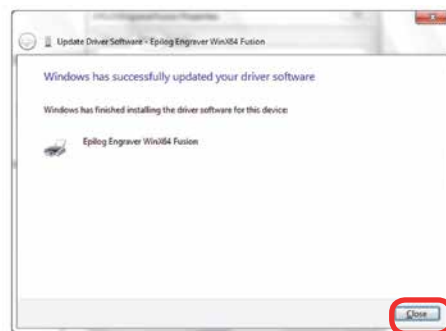

20. Click **Close** in the next window and then **Close** again. You will then see your laser driver in the Devices and Printers page. Click on the red X in the upper right corner of this page. That's it! You are ready to print to your laser.

21. If you will be printing from CorelDRAW, go to **“Setting Up CorelDRAW Beziers Setting” on page 31**.

# SECTION 3: DRIVER INSTALLATION

Windows 7: USB Installation

## Windows 8 and 10: Ethernet Installation

1. Insert the Driver CD in the computer and select your laser system.



2. Select the Dashboard Driver.



You can also download the latest driver from [epiloglaser.com/tech-support/epilog-drivers.htm](http://epiloglaser.com/tech-support/epilog-drivers.htm). Go to **Devices and Printers** on your computer and click **Add a Printer** to start the process.

3. **Windows 8 and 8.1/10 have different paths.** Choose your operating system:

### In Windows 8:

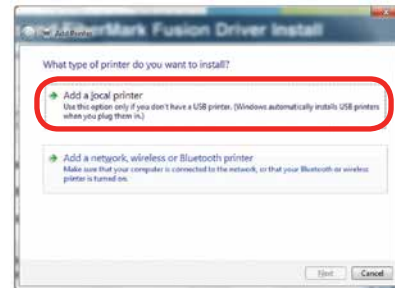

4. **In Windows 8.1/10:** Select **The printer that I want isn't listed.**

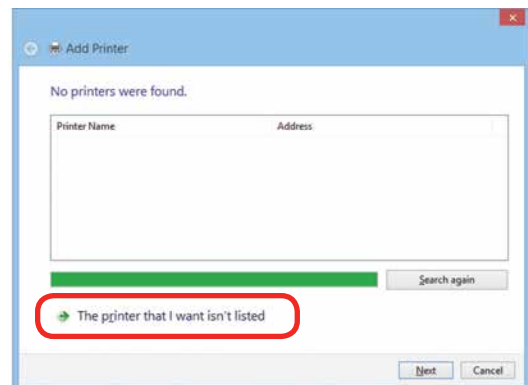

Click **Add a local printer or network printer with manual settings.** Click **Next.**

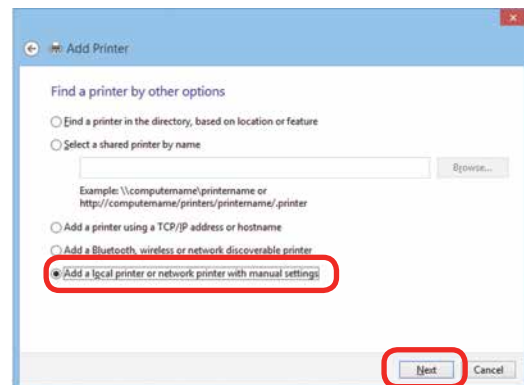

# SECTION 3: DRIVER INSTALLATION

Windows 8 and 10: Ethernet Installation

5. Select **Create a new port**, then **Standard TCP/IP Port**. Click **Next**.

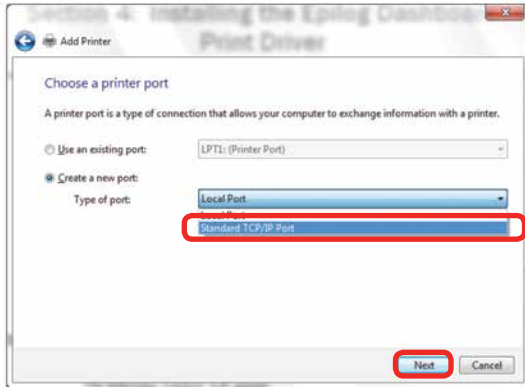

6. Enter the IP Address to match the IP Address you set at the Fusion laser in **“Setting the IP Address” on page 16**. Most Epilog users will use the IP Address of 192.168.3.4, which is what we use in this document. After typing in the IP Address, click **Next**. Wait while the computer identifies the port.

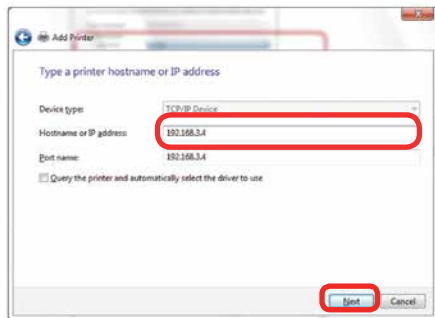

7. Select **Custom**, then **Settings**.

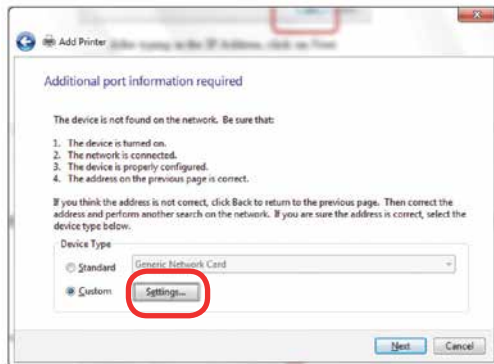

8. **Set Protocol to LPR**. This is a very important step. Your download time will be greatly increased if LPR is not selected. Type **Laser** into the Queue Name and click **OK**.

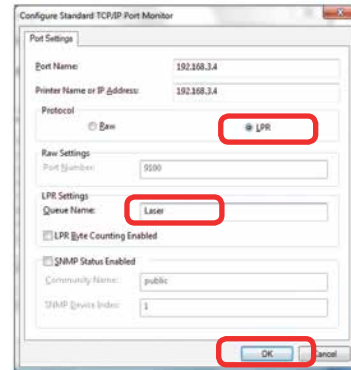

9. Click **Next**.

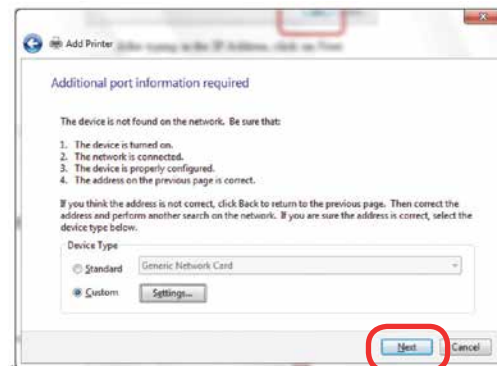

10. Click **Have Disk**.

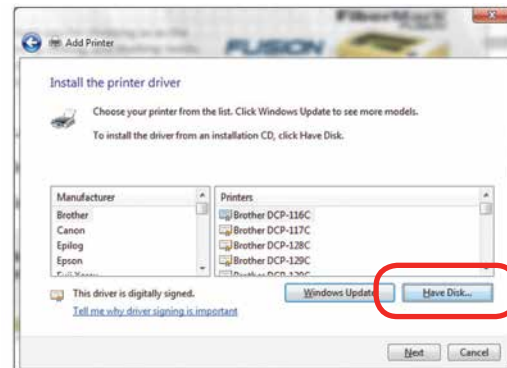



# SECTION 3: DRIVER INSTALLATION

Windows 8 and 10: Ethernet Installation

11. Click **Browse**, browse to the folder where you saved the download. The default location is c:/fusion\_driver.

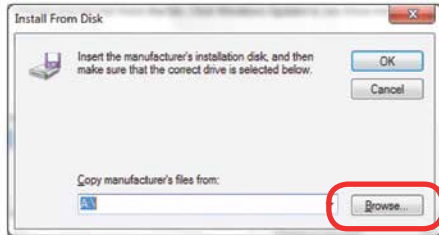

12. Click **EpilogWinALLFusion** file and click **Open**.

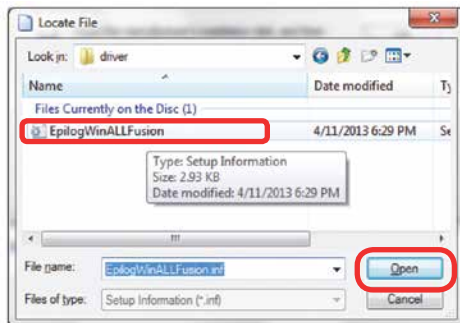

13. Click **OK**.



14. Click **Next**.

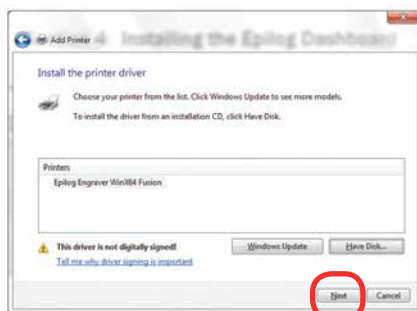

15. Click **Replace the current driver** if requested and click **Next**.

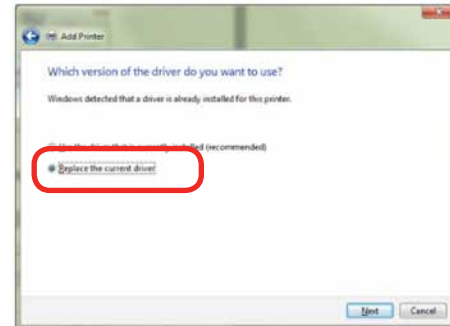

16. You can rename your printer here. We have not changed it for this document, but many users like to associate the driver name with the IP Address they are using, especially if there is more than one laser connected to a single computer. For example, we might rename the driver **Fusion 192.168.3.4**. Click **Next**.

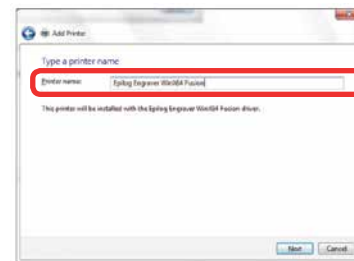

17. If you see this page, click **Always trust software from "Epilog Corporation"** then **Install**.

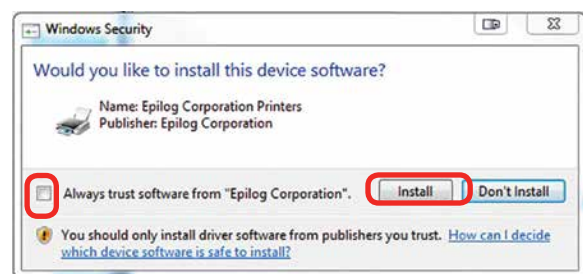

18. Click **Next**.

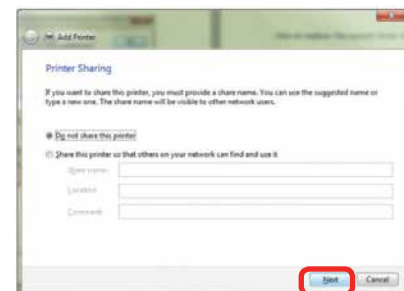

# SECTION 3: DRIVER INSTALLATION

Windows 8 and 10: USB Installation

19. Click **Finish** and your driver is installed.

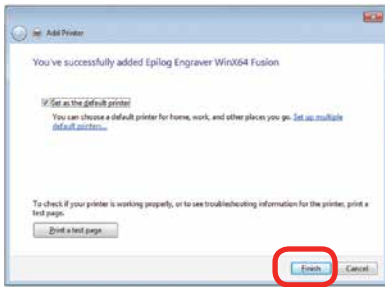

20. **You must now restart your computer** before you print to the laser.

21. If you will be printing from CorelDRAW, go to **“Setting Up CorelDRAW Bezier Setting”** on page 31.

## Windows 8 and 10: USB Installation

Windows 8 will not automatically walk you through the installation process so it is important to follow the instructions below.

1. Insert the Epilog driver install disc into your computer (or download the files from the website). One of the following screens will appear. For the USB installation, you will want to close them. We do not want the computer to automatically try to install the driver.

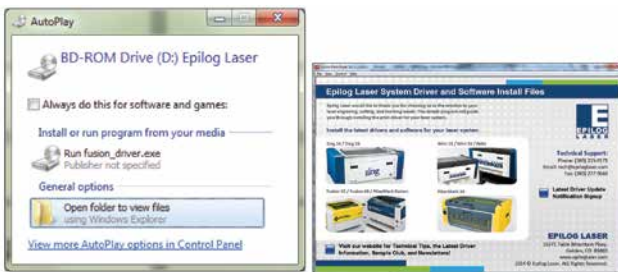

2. With the power of your laser turned off, **connect the USB cable** to your computer and your Fusion.  
3. **Power on** your laser system. It will take about a

minute for the laser to initialize.

- 4. Once your laser has initialized, there will not be any real indication on your computer that it is ready to install the Epilog driver, but it is ready.
- 5. **In Windows 8**, open the Charms Bar and click on the **Search** charm. To access the Charms Bar move your mouse into the lower right corner of your display.



- 6. Type the word **Control** into the search bar. Click on the Control Panel box under Apps in the upper left of this window. **In Windows 10**, you can search for this from the desktop.

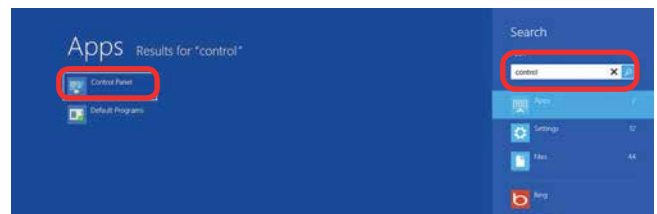

7. Click **Devices and Printers**.

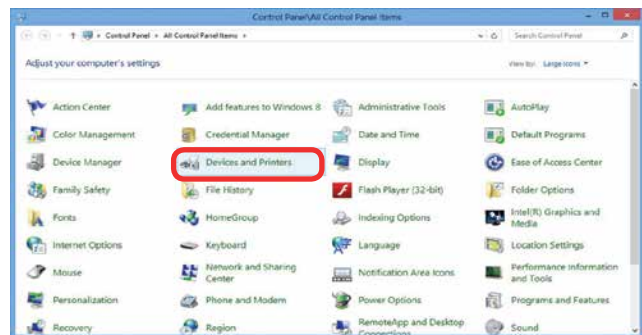

# SECTION 3: DRIVER INSTALLATION

Windows 8 and 10: USB Installation

8. In the Unspecified section of Devices and Printers, right click on the Fusion icon, then click **Properties**.

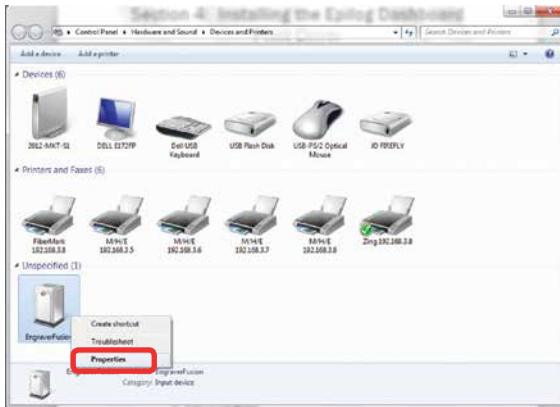

9. Select the **Hardware** tab.

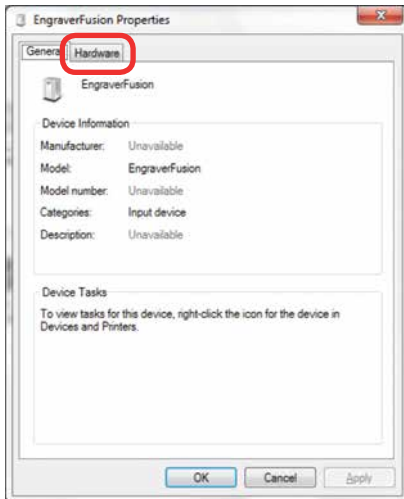

10. Select the device **EpilogEngraver**. Then click **Properties**.

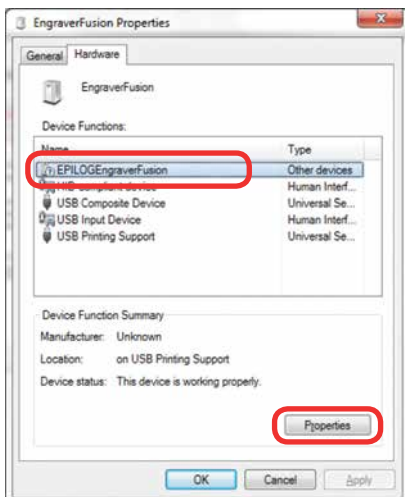

11. Click **Change Settings**.

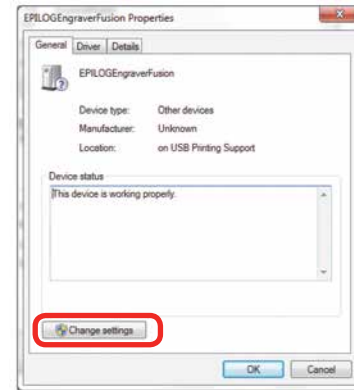

12. Click the **Driver** tab.

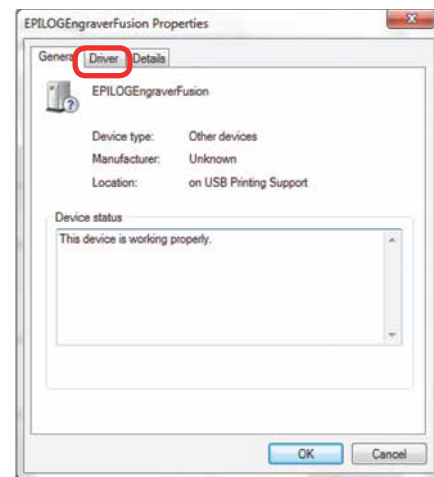

13. Click **Update Driver**.

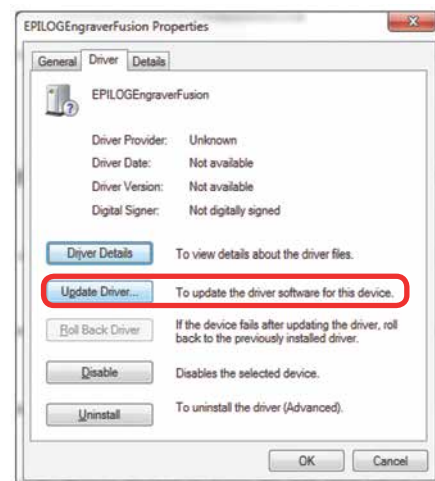

# SECTION 3: DRIVER INSTALLATION

Windows 8 and 10: USB Installation

14. Click **Browse my Computer for driver software**.

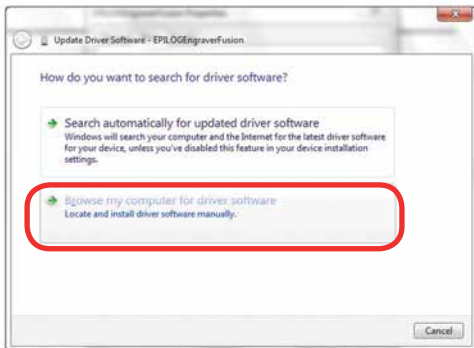

15. Use the **Browse** key to direct your computer to your disc drive that contains the Epilog driver disc that you inserted earlier in this process.

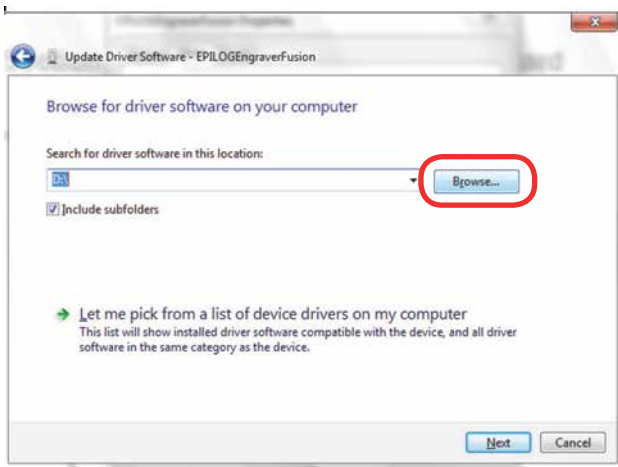

16. Find the disc drive with the Epilog install disc and click **OK**.

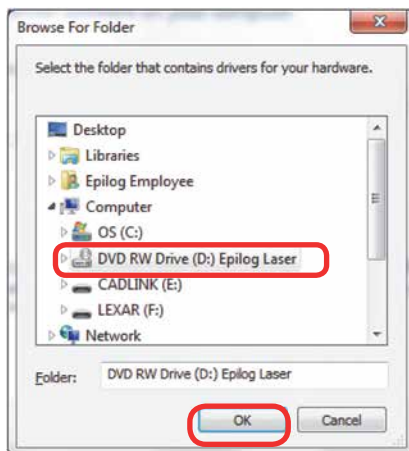

17. Once you have the proper disc drive showing click the **Next** key.

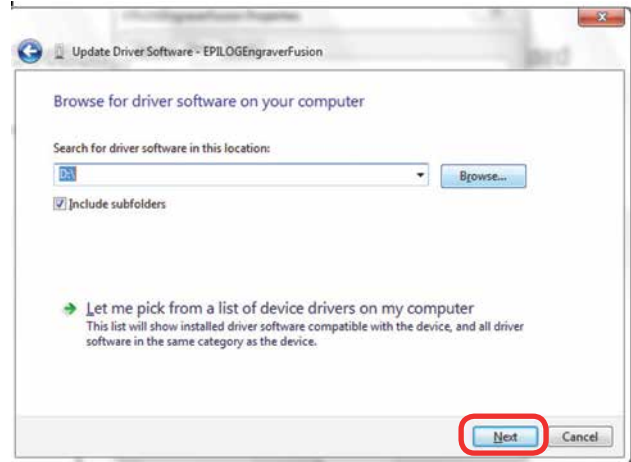

18. Wait while until the progress window disappears, then you may be asked if you want to install this driver. Click **Always trust software from "Epilog Corporation"** then **Install**.

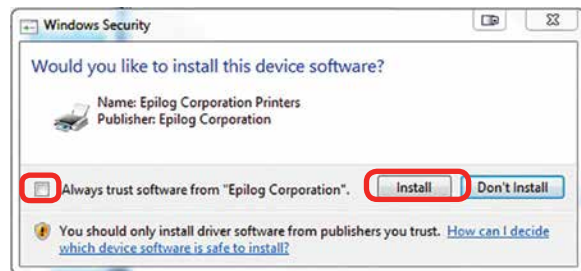

19. Your Epilog Laser Print Dashboard has been successfully installed on the USB port. Click **Close**.

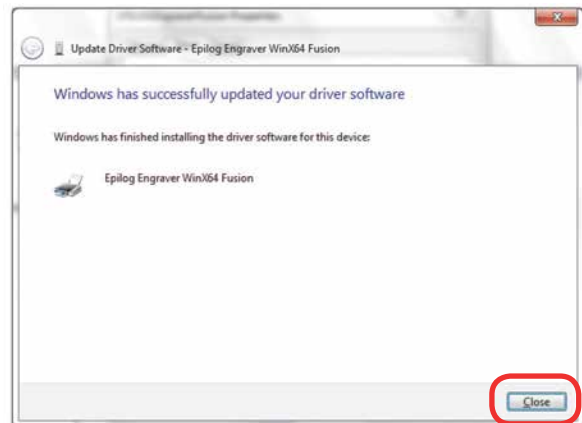

# SECTION 3: DRIVER INSTALLATION

20. In the next window, click **Cancel**.

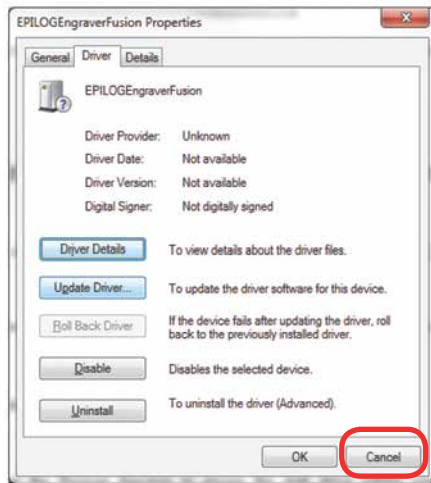

21. You will see your driver in the Devices and Printers page. Click on the **red X** in the upper right corner of this window and you are ready to print!

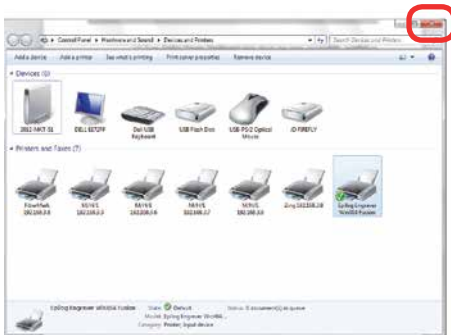

22. If you will be printing from CoreDRAW, follow the next steps for **Setting CoreDRAW's Beziers**.

## Setting Up CoreDRAW Beziers Setting

Due to the way that the Fusion series handles vector lines, there is a setting in CoreDRAW that needs to be changed for vector cutting to work properly. This only affects CoreDRAW and is not necessary if you are using other graphic software.

1. In CoreDRAW, go to **Tools > Options**.

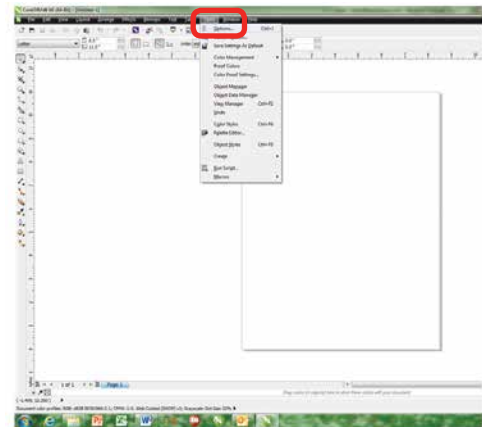

2. Under **Global > Printing**, choose **Driver Compatibilities**. Next to Printer choose the **Fusion Laser you just installed**. Check the box **Send beziers and paths to driver** and click **OK**.

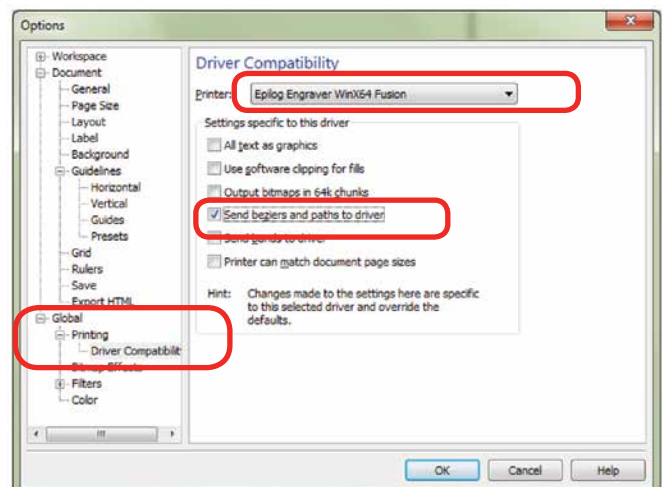

## Mac Driver Installation

### Installing the Epilog Mac Driver for the First Time



If you already have the Mac Driver installed and just want to add the ability to work on Sierra OS, go to “**Installing the Mac Driver on Sierra OS**” on page 33.

- Go to [epilogfiles.com/epilog-test/EpilogApps.dmg](http://epilogfiles.com/epilog-test/EpilogApps.dmg) and double click to load the file.
- The following screen will appear. First double click the **GhostscriptInstaller.mpkg** file.

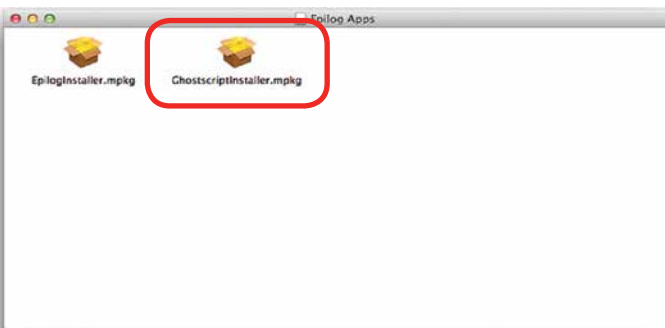

- A welcome screen appears. Click **Continue**.

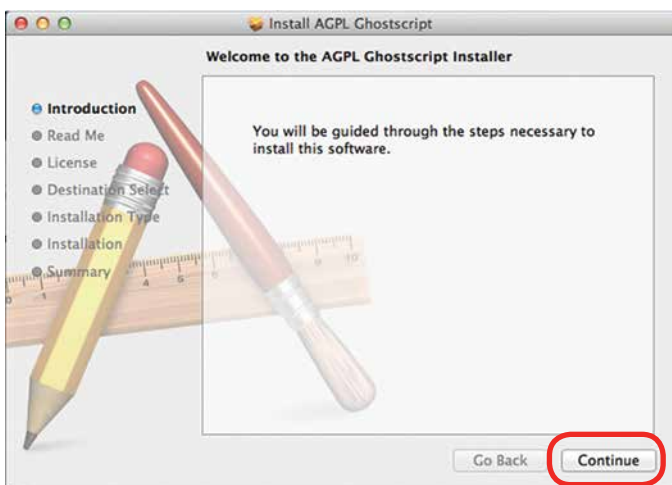

- Click **Continue**.

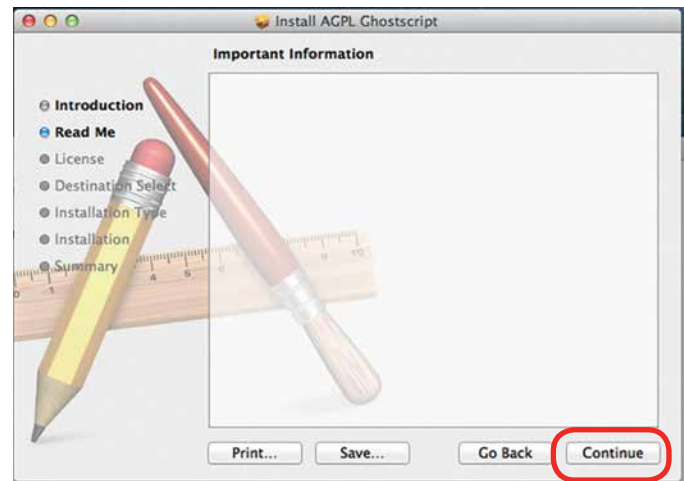

- The software license agreement will appear. Click **Continue**.

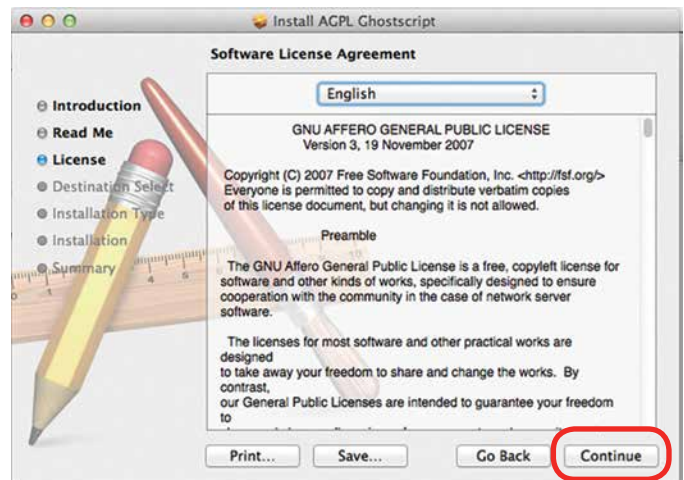

- Choose to **Read License** then click **Agree**.



# SECTION 3: DRIVER INSTALLATION

9. Select **Install**.

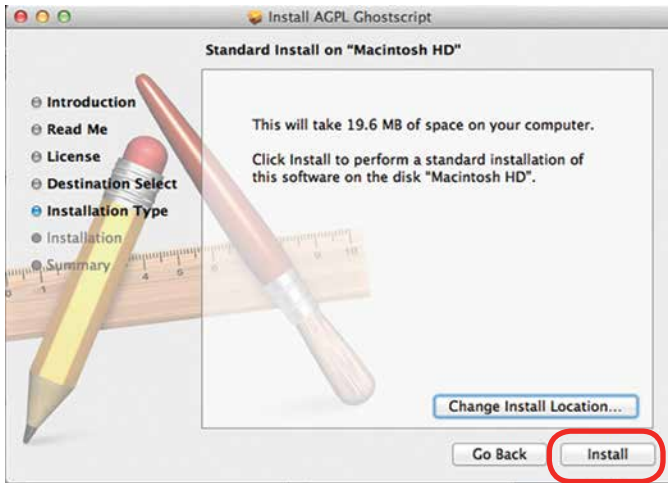

10. Type in the password **epilog** (lower case) as the password then click **Install Software**.

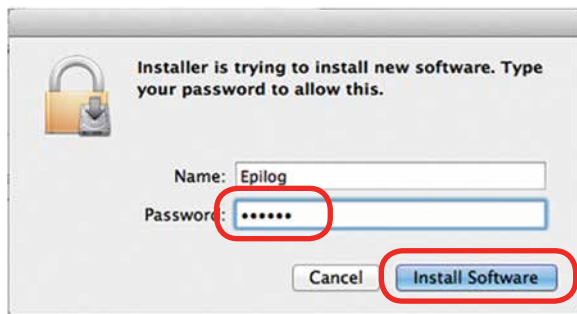

11. Press **Close** to finish the first part of the install.

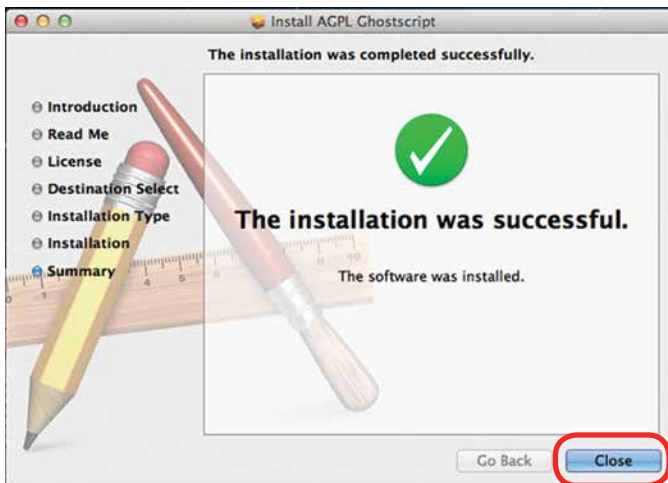

12. Go back to the installer and double click **EpilogInstall.mpkg**.



13. The installation process for the EpilogInstaller is the same as for the Ghostscript file. At the end of the installation you will be asked to reboot. **Reboot to complete the driver installation.**

## Installing the Mac Driver on Sierra OS

To install the Mac Driver on Sierra OS there are a few additional steps.

1. Go to **Settings**.



# SECTION 3: DRIVER INSTALLATION

## 2. Select **Printers and Scanners**.

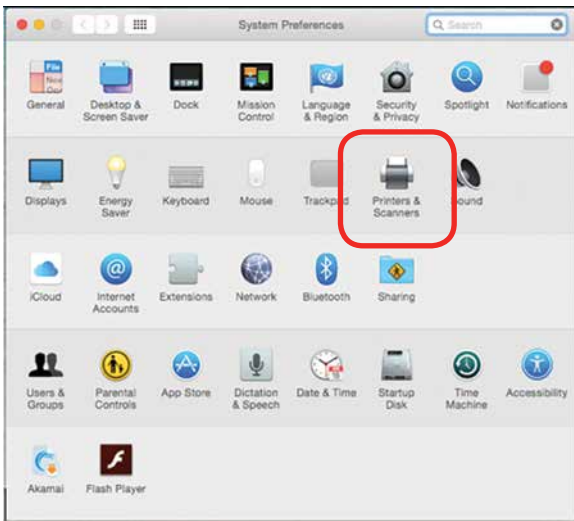

## 3. **Highlight and delete** any existing Epilog drivers by selecting the **minus symbol**.

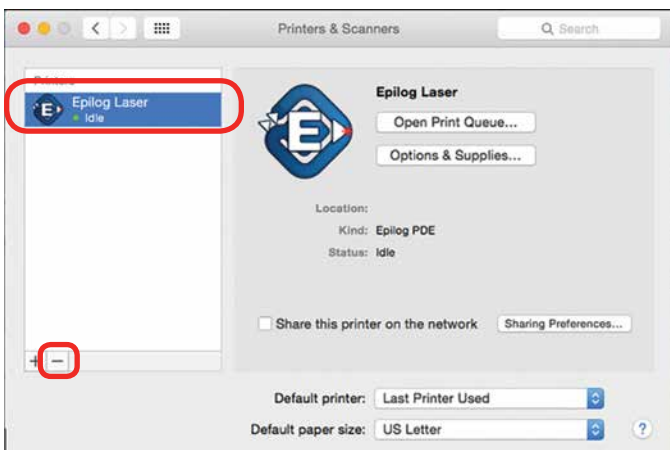

## 4. Add a new driver by clicking the **plus symbol**.

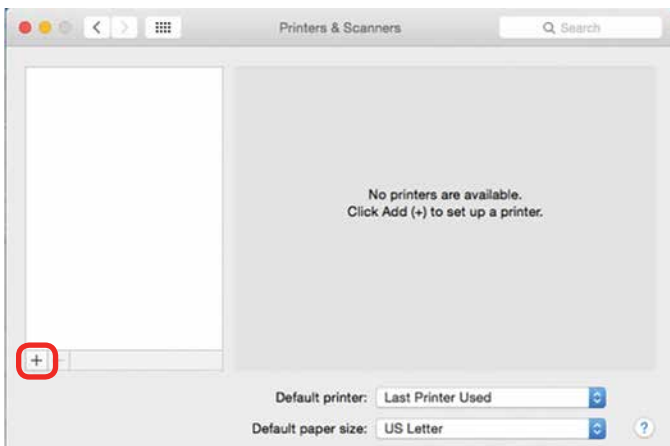

## 5. Click the **IP icon**.

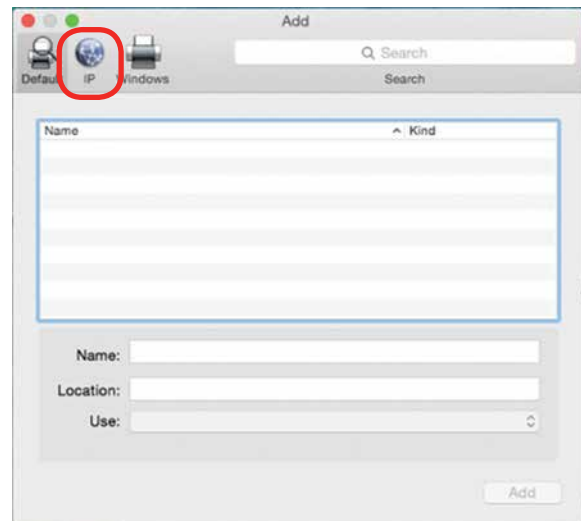

## 6. Fill out the following information:

- a Type **127.0.0.1:55000** next to address.

 Important! Notice that a colon separates the 1 and 55000.

- b Set Protocol to **HP Jetdirect - Socket**.

- c Provide a name for the printer. We have named the printer **Epilog**.

- d In the Use drop-down menu, click on **Select Software**.

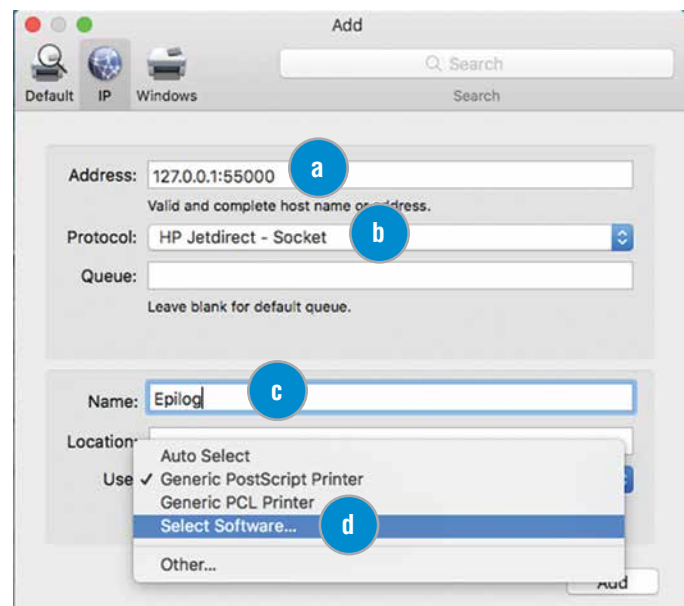



# SECTION 3: DRIVER INSTALLATION

7. Select **Epilog Corporation Epilog PDE**, then click **OK**.

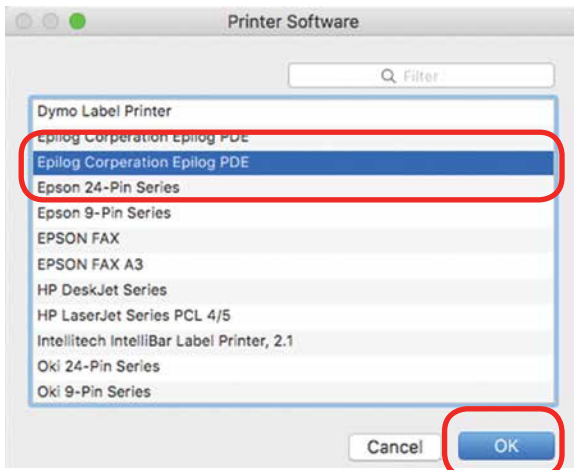

8. Click **Add**.

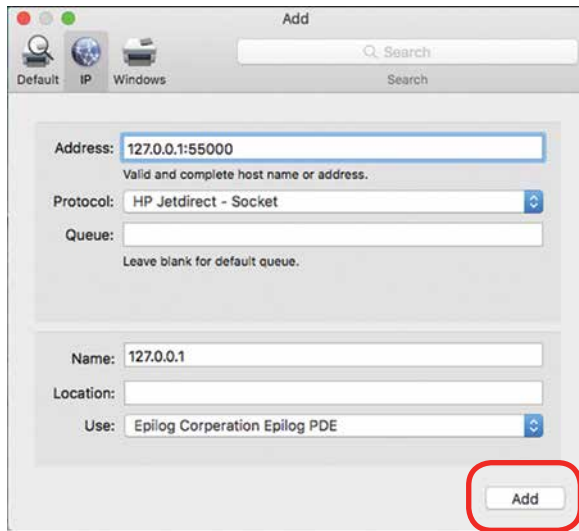

9. And you're done! The Mac driver has been installed.



11. Go to the **Finder/Applications**.

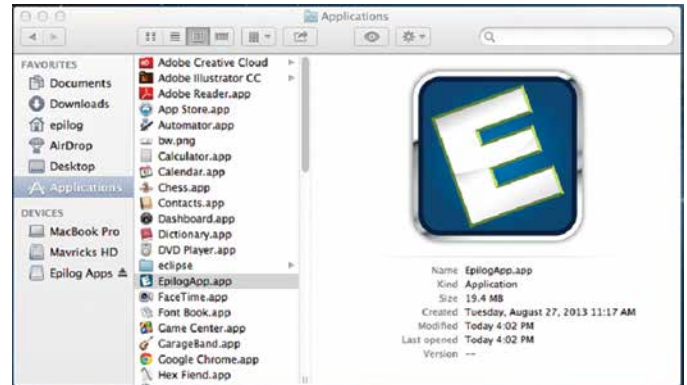

12. Finally, drag the **Epilog icon** into the dock.





# SECTION 4: THE EPILOG JOB MANAGER

## Epilog Job Manager Instructions

The Epilog Job Manager is a powerful new tool that will quickly become one of your favorite features on your laser system. From one piece of software, you can access any job you have sent to the laser, view the settings you used on any past job, re-run projects, access your material database, and much more. It's a great addition to the Epilog Laser product features, and we look forward to seeing how our customers use this software!

- **Windows 7/8/10 is required** to use the Epilog Job Manager.

## How to Install the Epilog Job Manager

1. If you have a previous version of the Epilog Job Manager installed, **you must uninstall it** before you continue.
2. On your driver CD, select the Job Manager.

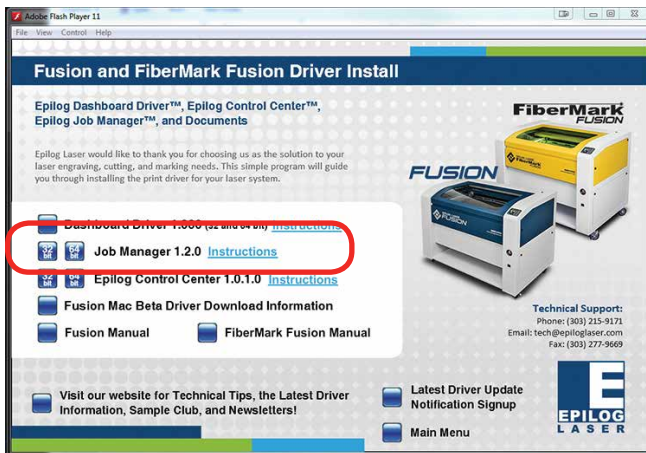

You can also download the Job Manager from [epiloglaser.com/tech-support/drivers.htm](http://epiloglaser.com/tech-support/drivers.htm).

3. In Windows 8 or 8.1 you **may** see this message. Click **More Info**.

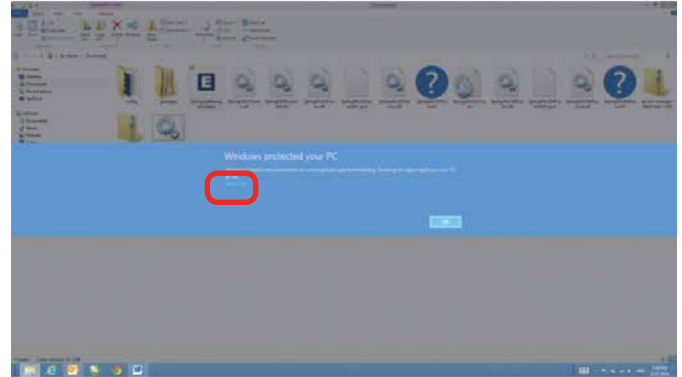

4. Click **Run Anyway**.

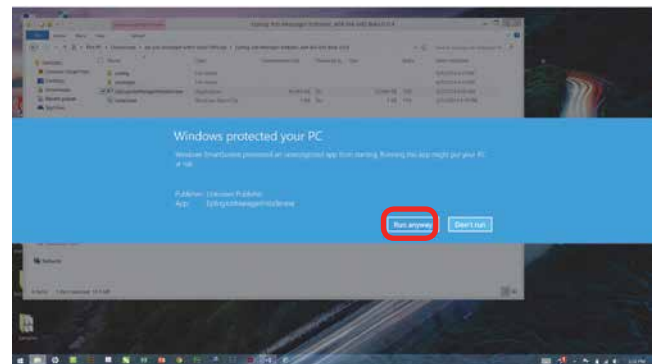

5. Click **Next**.

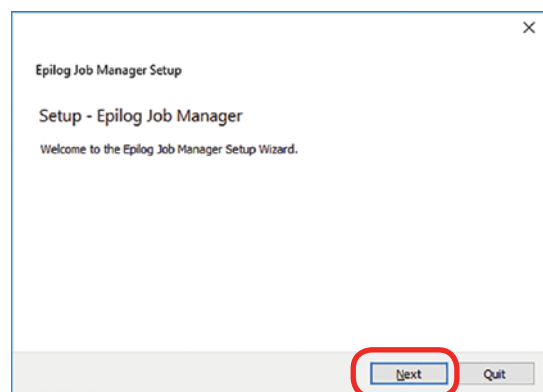

# SECTION 4: THE EPILOG JOB MANAGER

How to Install the Epilog Job Manager

6. Click **Next**.

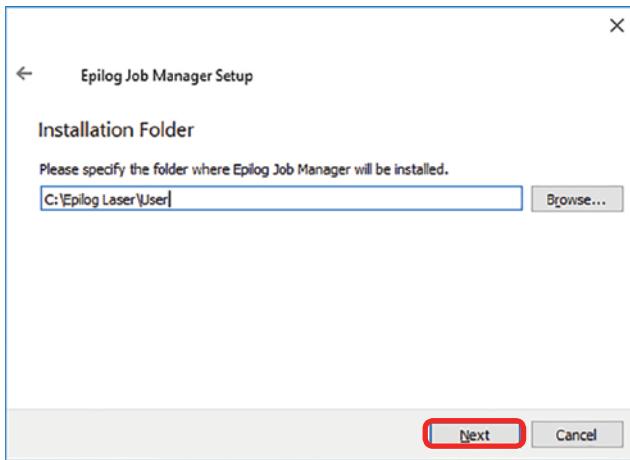

9. Click **Next**.

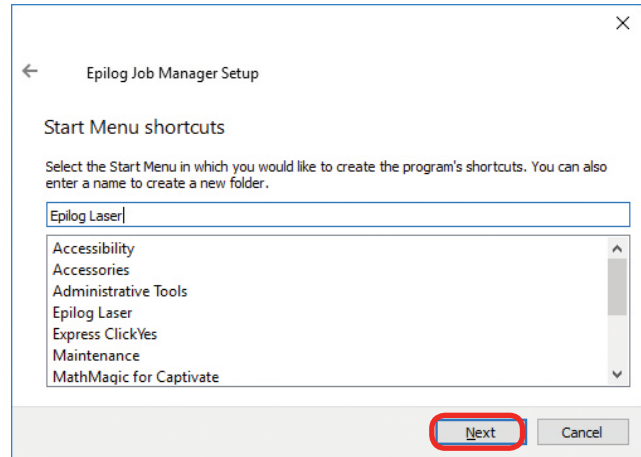

7. Click **Next**.

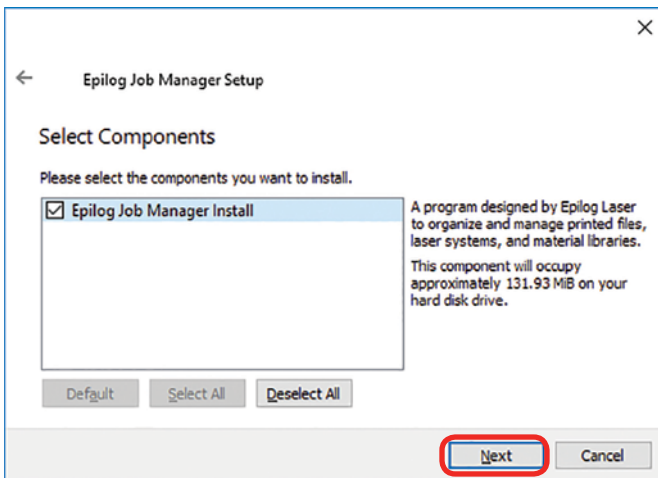

10. Click **Install**.

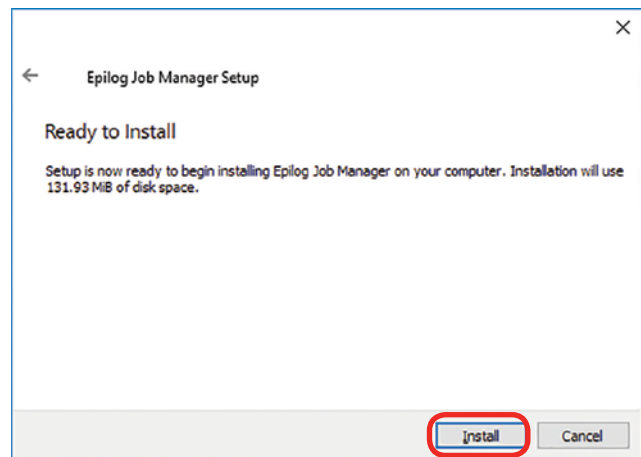

8. **Accept the license**, then click **Next**.

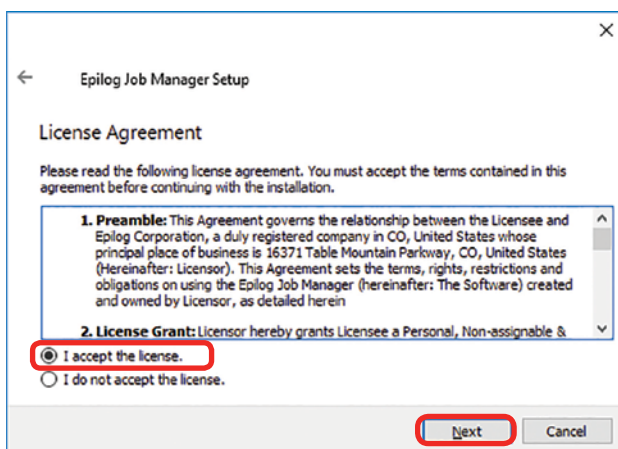

11. The installation will take a few moments.

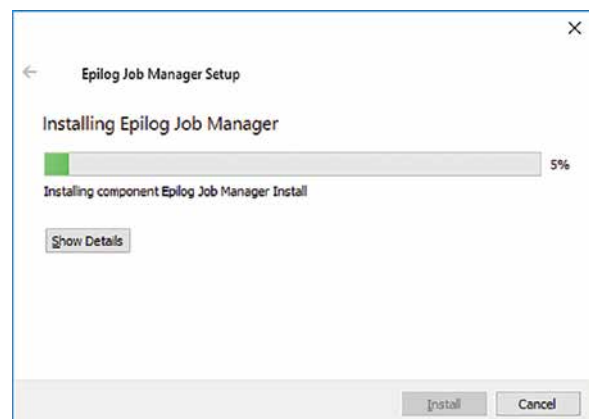

# SECTION 4: THE EPILOG JOB MANAGER

Trouble Shooting Job Manager Installation

12. Click **Finish** and the Job Manager is installed.

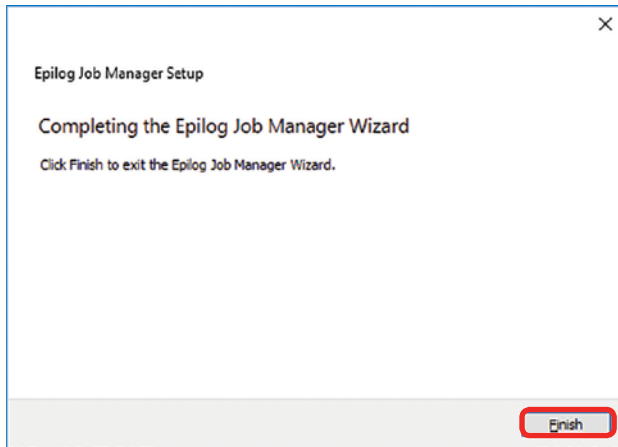

13. A Job Manager icon will be automatically added to your Desktop. You are now ready to use the Job Manager.



## Trouble Shooting Job Manager Installation

If you were unable to install the Job Manager, it's possible that your Anti-Virus software is blocking installation.

To disable Symantec Anti-Virus software, choose **Options**. Other anti-virus packages should have something similar to Symantec.



Disable all Virus and Spyware Protection Features. After the Job Manager has been installed go back into your Anti-Virus software and re-enable the setting that was disabled.

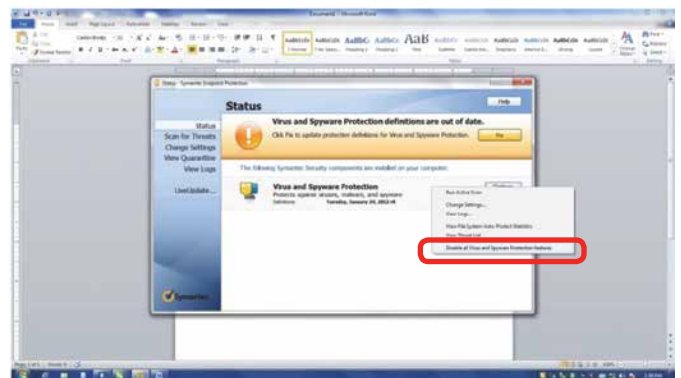

# SECTION 4: THE EPILOG JOB MANAGER

Important Epilog Job Manager Notes

## Important Epilog Job Manager Notes

-  **Warning:** Before activating your laser, install the newest version of the driver to properly associate the correct machine with the Job Manager.
- We suggest a **minimum of 1 GB of free RAM** space when managing very large raster and vector jobs.

## Using the Epilog Job Manager

### Activate a Laser

1. The first time you open the Job Manager you'll see a tab for each of the models. You will need to activate your laser system to get started. **Click the correct tab, then your system.** You can activate multiple machines if you have more than one laser.

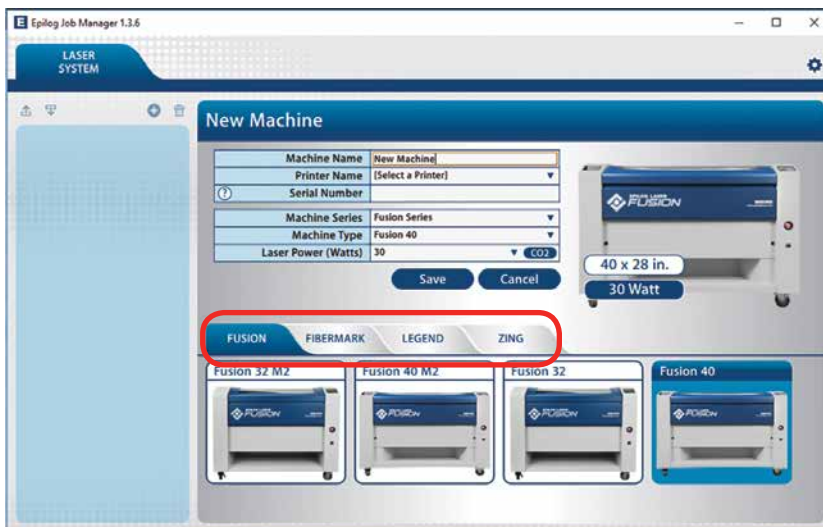

2. To activate your machine:

- **Machine Name:** Give your machine a name (Fusion M2 32).
- **Printer Name:** Select your installed laser from the drop-down list. Important - if you do not choose the correct printer you will not be able to print from the Epilog Job Manager!
- **Serial Number:** This is not your machine serial number, but the USB serial number that can be found in your system's Settings menu. On the laser's control panel, arrow down to **Settings**, then move the **Joystick down** until you see **Serial #**.
- Select the correct machine series, wattage, etc. The Laser Power is very important because it will automatically load the proper material setting files for your specific wattage of laser.

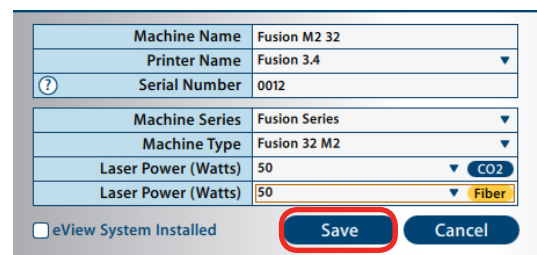

# SECTION 4: THE EPILOG JOB MANAGER

Using the Epilog Job Manager

- Select **eView System Installed** if you have the optional eView Camera Module installed.
  - Click **Save**.
3. Your new laser has been activated in the Job Manager and appears in the left panel. The Job Manager is now ready to accept jobs from the print driver. Use the **Add or Delete** keys to add additional machines or to remove a laser. Below you can see we have installed an additional Helix laser system to the Job Manager.



## Setting Up the eView Camera Module

If you have the eView Camera installed on your Fusion laser system, associate your eView Camera with the correct laser. Follow the following steps:

1. Click on the Gear icon in the top left corner to open the Program Settings.



2. Select the Camera tab, then select the system you activated from the drop-down list if you have more than one laser activated. Click **Save** to finish.

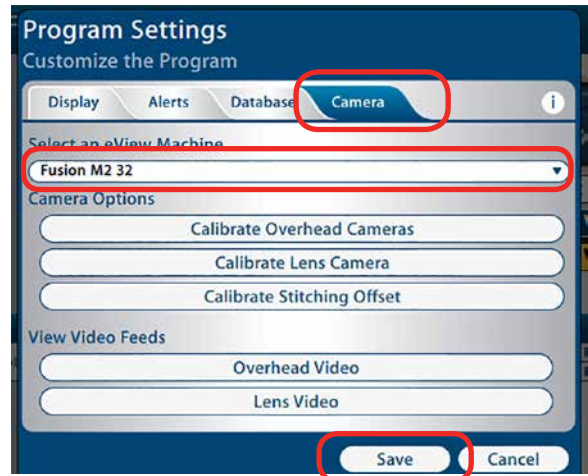

## Printing to the Epilog Job Manager

Create a file in your graphic software and set your laser parameters in the print driver.

In the driver you'll see a selection available under the Center-Engraving area. You can choose to print to either the printer (your laser system), the Job Manager, or both. This allows you to send your job to the Job Manager without sending it to the laser so you can then print that job directly from the Job Manager at a later time without accessing your graphic software. This is an easy way to set up an entire day's jobs all in one place.

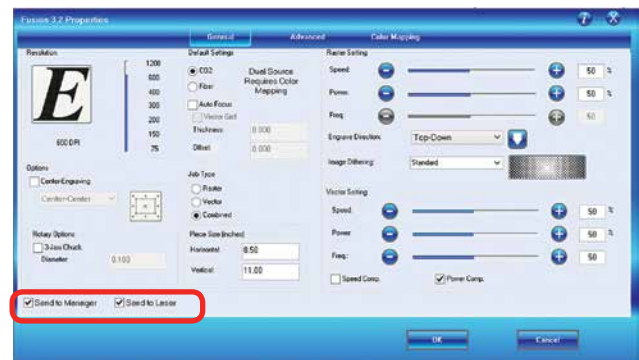

# SECTION 4: THE EPILOG JOB MANAGER

Using the Epilog Job Manager

## Organizing Your Print Jobs

Click the **Jobs** tab. All print jobs will be displayed in the Uncategorized folder. Click on your job to highlight it. You can now Print, Edit, Preview or Delete this job using the available icons.

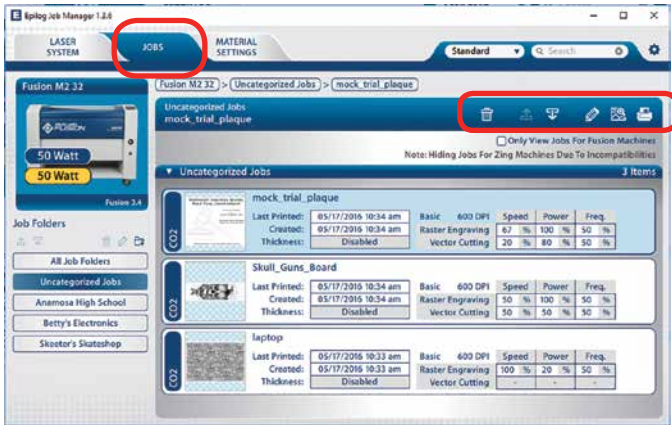

## Create and Delete Job Folders

Click the **Add Job Folders** icon to add folders. We added folders for this customer's three largest customers. You can add as many folders as you'd like.

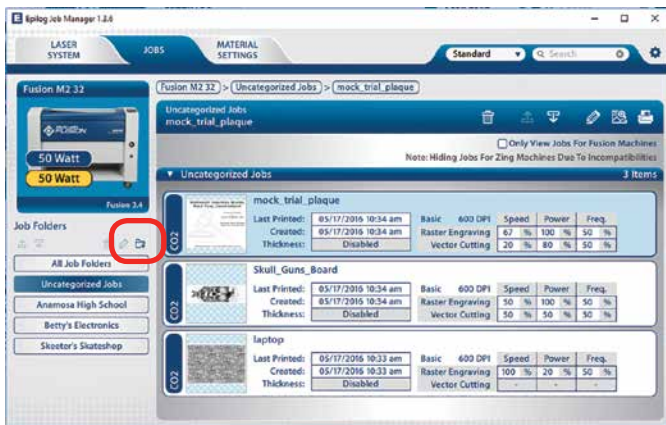

Type in the folder name and click the **check mark** to create your new folder.

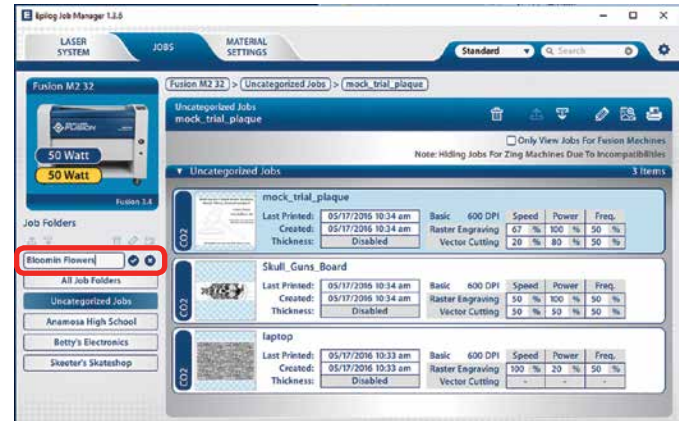

## Move an Uncategorized File to a Folder

When you highlight a folder you will see **From Uncategorized** on the right side of the folder. Click **From Uncategorized** to move a job from the Uncategorized folder to this subfolder. **Select the job** you want to move and click **OK**.

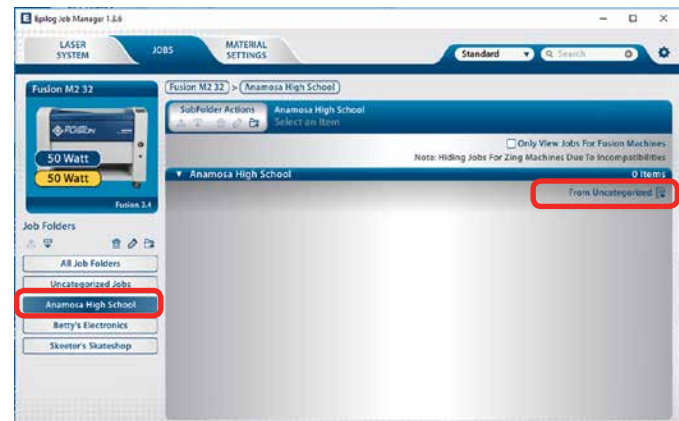



# SECTION 4: THE EPILOG JOB MANAGER

Using the Epilog Job Manager

## Create Subfolders

First highlight the folder in the left panel where you want to add a subfolder. Below we have highlighted the Anamosa High School folder. Click the **Add Subfolder icon**. Type the subfolder name in the **Add SubFolder** field, then click the **check mark** to create the subfolder.

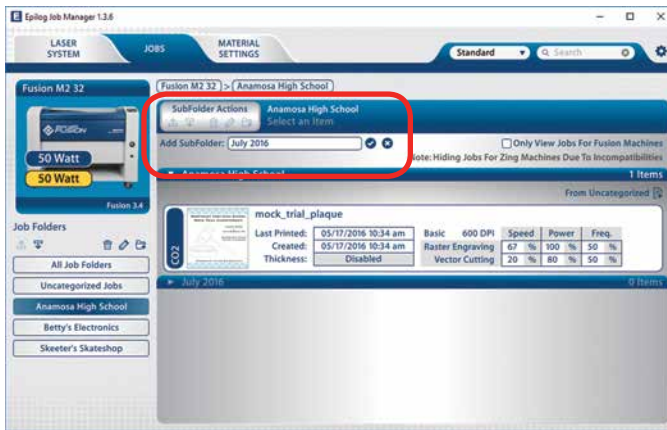

## Move a Job Between Folders

You can also move any job to another folder or subfolder by **double-clicking on the job**. Select the Folder and Subfolder from the drop-down menus where you want to save the job. You can save the job with the same name or you can save as a new job. You can also modify your laser settings and save them with the job. Click **Save** to continue.

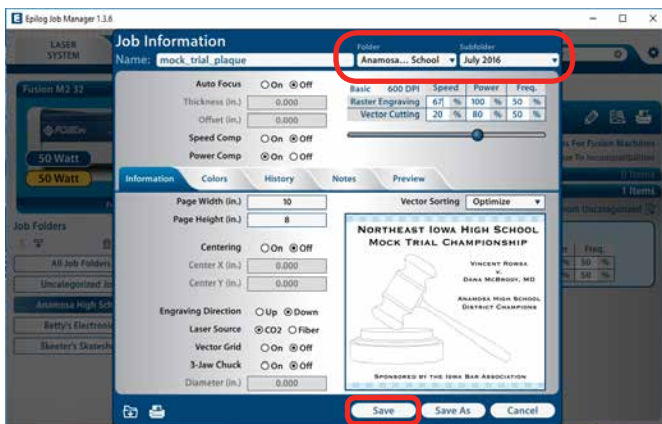

## Using the Material Setting Configurations

The Material Settings tab stores all of the suggested laser parameters like speed, power, etc. These settings were loaded based on the wattage you specified in the Laser System tab (adding your laser was the very first thing you did to start using the Job Manager).

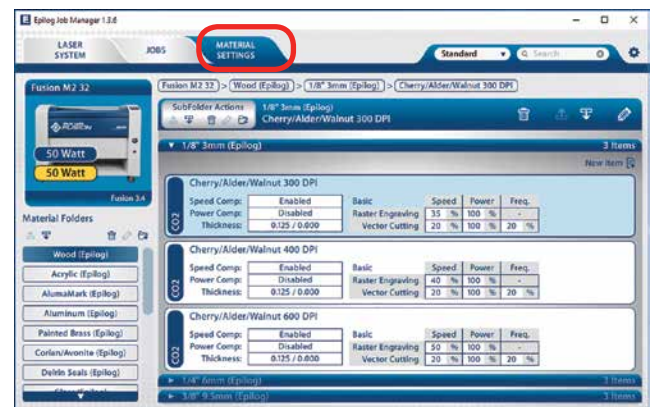

To use the material settings that are automatically loaded in your Job Manager, go to the **Jobs** tab and **double-click on the job** you want to process.

Click the **Import** icon.

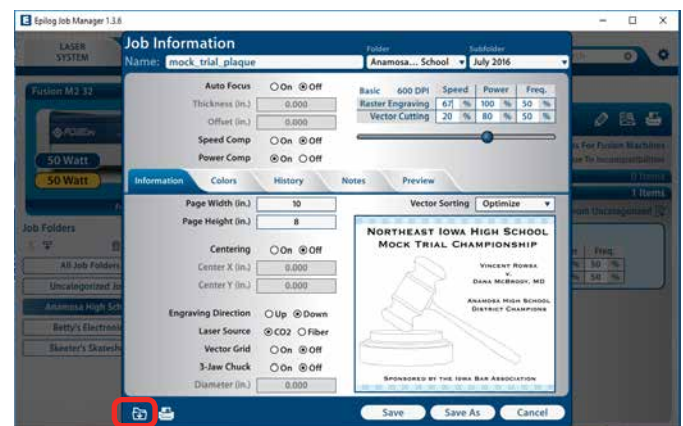

# SECTION 4: THE EPILOG JOB MANAGER

Using the Epilog Job Manager

Navigate to the material setting you need. We have highlighted **1/8" Cherry/Alder/Walnut 300 DPI**. Click **OK**. Your new settings have been automatically applied to your job file. You can now save this file, save the file as a different name or print from this window. Double clicking on the artwork will take you to the full preview window, which is explained in the next frame.

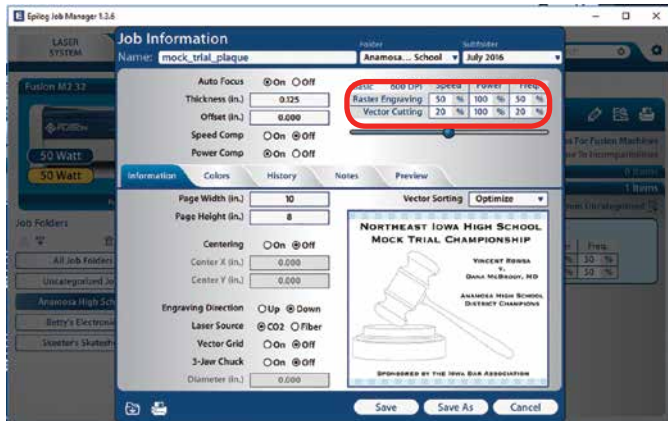

In the Preview mode can preview just the raster components of your job, or just the vector components. We have selected vector to show only the vector components of this job. The preview mode is very useful in identifying unwanted vector components in a job.

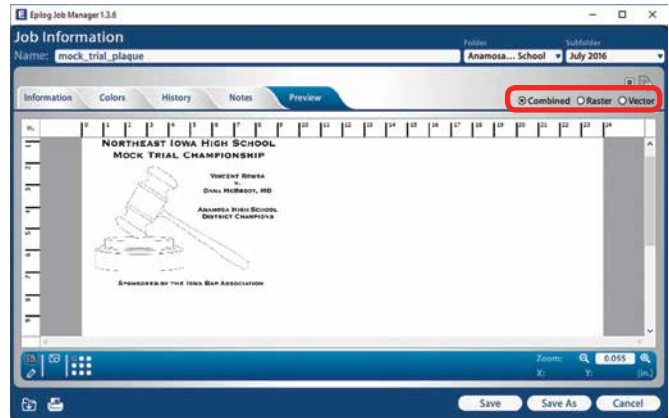

## Previewing Your Job

To view a preview of the job, click on the Preview tab.

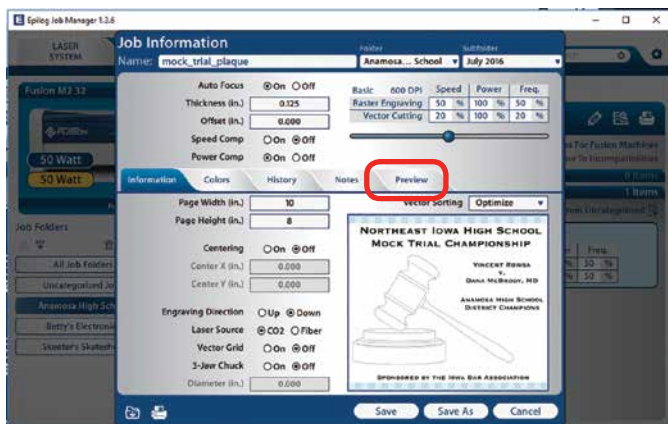

## Searching For a Job

The Job Manager has a powerful search function. Type in part of a file name and press enter to find all files related to that name.

You can organize files by category, creation date, print date, or alphabetically to find a specific file.

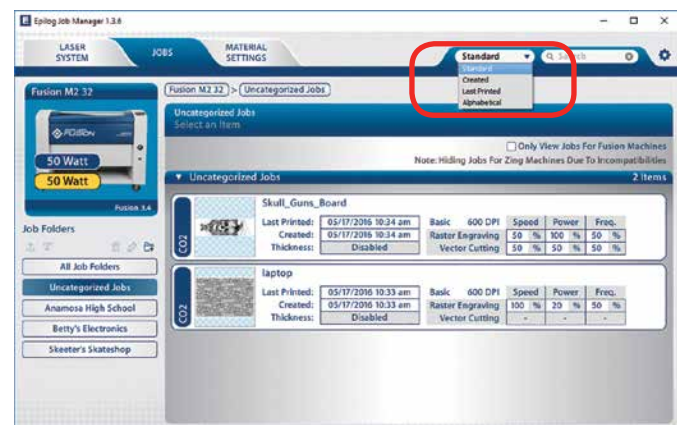

# SECTION 4: THE EPILOG JOB MANAGER

Using the Epilog Job Manager

Notice that the jobs are displayed differently if you change the search category to **Alphabetical**. Your jobs are now displayed in alphabetical order. Once the search is finished and the job is found, most users revert back to the default selection of **Standard**.

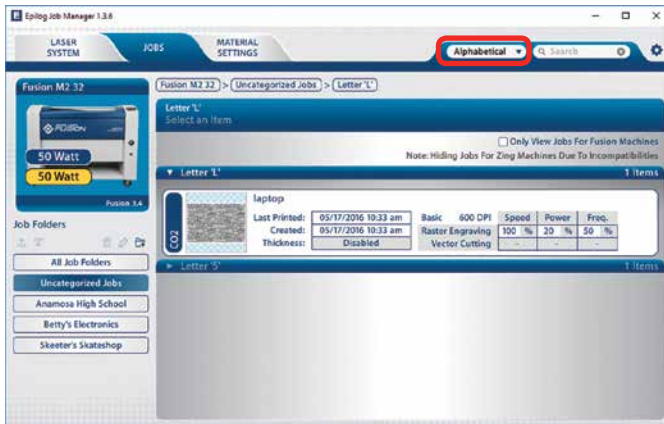

## Color Mapping

To access the Color Mapping settings used in a file, double-click on the file to open the Job Information, then click the **Colors** tab.

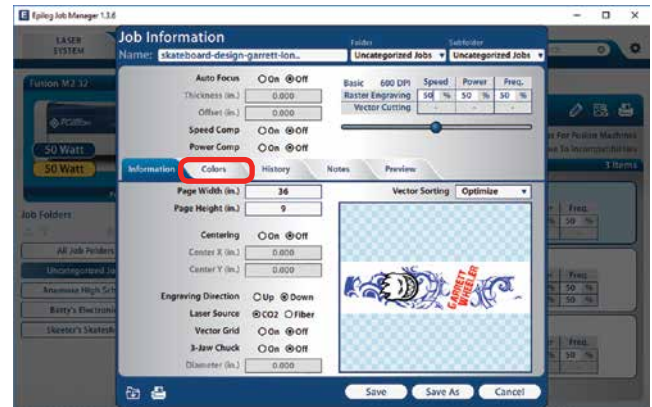

You can modify the settings, save as a new job, save as the same job, print, preview, etc from this window.

## Finding Job History

Click the **History** tab to see a full print history of a job, including settings you used in each print. You'll see what machine it was printed to, when it was first printed (Initial Print), all subsequent prints, and all laser parameters used. To access this, double-click on the job, then select **History**.

You can modify, print or save from this window using the listed settings or with new setting. The new setting will be saved as the next print job complete with time stamp and date.

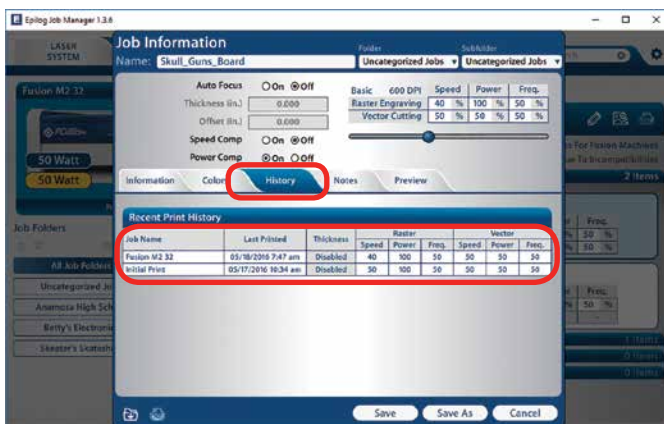
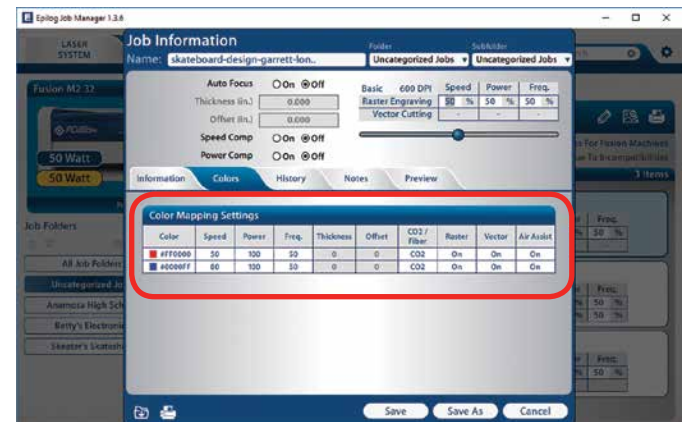

# SECTION 4: THE EPILOG JOB MANAGER

Using the Epilog Job Manager

## Vector Sorting

You can determine the cutting order of vector lines directly from the Epilog Job Manager.

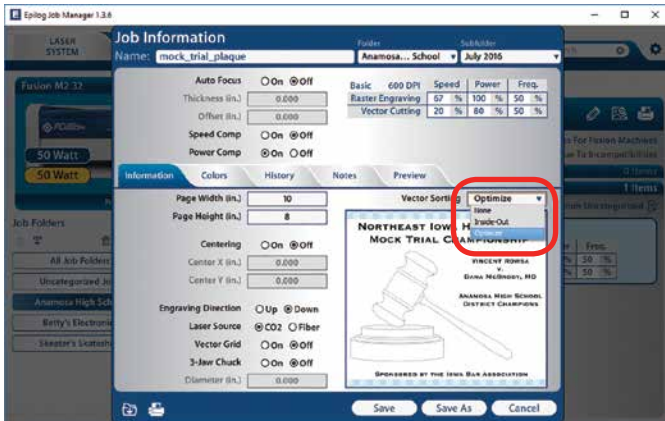

You can choose from three different vector sorting options:

1. **None:** Vector line cutting order is determined by the order they were created.
2. **Optimized:** The laser will process the vector lines looking for the next closest node for quicker vectoring.
3. **Inside/Out:** All internal vector paths in the file will be process prior to the external vector paths. For example, if cutting the letter O, the inner oval will be cut before the outer oval.

## Changing Program Settings

You can access the Program Settings by clicking on the gear at the top left of the page.



On this screen you can set several different system settings, including:

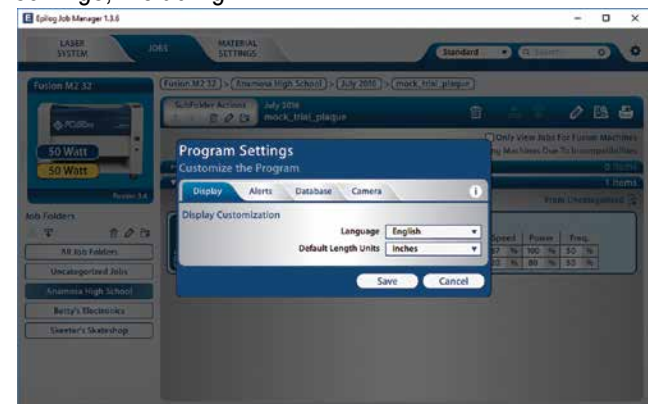

### Display Tab:

- **Language:** Choose from several languages.
- **Default Length Units:** Choose from inches, millimeters, or centimeters.

### Alerts Tab:

Choose when the program asks for confirmation when you delete machines, folders, subfolder, jobs and materials, or pages.

## SECTION 4: THE EPILOG JOB MANAGER

Using the Epilog Job Manager

### Database Tab:

- **Backup Database:** Save a backup of all files, material settings, etc.
- **Restore Database:** Reload settings from a previous backup.
- **Clear Entire Database:** Delete all settings, machines and jobs from the database.
- **Clear All Jobs:** Delete all jobs in the database.
- **Clear Uncategorized:** Clear out all uncategorized jobs in the database.

### Camera Tab:

Set which system has an eView camera attached.

We will be adding new features to the software often, so sign up for the Driver Update Notification list at [www.epiloglaser.com/tech-support/epilog-drivers.htm](http://www.epiloglaser.com/tech-support/epilog-drivers.htm).



# SECTION 5: USING THE LASER DASHBOARD™

The Epilog Dashboard is the print driver that sends your artwork and laser parameters from the computer to the laser.

The Dashboard is shown below and can be installed from the driver CD that came in your accessories kit. It can also be downloaded from the Epilog website. If you are just getting started and are in a hurry to engrave a job, you can do so by setting just a couple of parameters in the Dashboard without having a detailed understanding of what different choices are available to you.



**Note!** When using the slider bars, there are several different ways to get the desired setting. These different methods all follow standard Windows protocol, so they will work in other Windows software applications too.

- Change the settings by clicking on the slider bar to move it, or type in exact numbers to the right of the slider.
- Holding down the Alt key while clicking close to the slider will bring up a box outlining the slider and allow you to move in increments of ten.

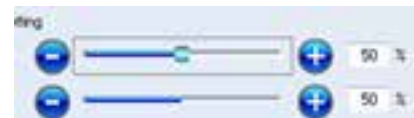

The following sections provide detailed explanations of the different features in the Print Driver. Most engraving and cutting jobs can be accomplished by using only the General tab of the Print Driver. Advanced features for more complex jobs can be found under the Advanced and Color Mapping tabs.

## Changing Laser Dashboard Defaults

If you would like to permanently change any of the settings that we walk through on the next few pages, you can easily set a new default for each of them.

1. Go to **Control Panel | Devices and Printers**
2. Right mouse click on the Epilog Engraver.
3. Click **Printing Preferences**.
4. Change any of the settings. These changes will become the default settings for each new print job.
5. Click **OK** and close out all open windows.

## When would you want to do this?

Most users set their defaults to match the materials they use the most. They might set the speed default to 100% because they only engrave acrylic. They might only vector cut so they set the default Job Type to vector, or they might set the page size to match the size of the engraving table. By following these quick steps you can make sure that these are the settings you see every time you open the print driver.

## General Tab

The General Tab is where you will find 90% of the features you will utilize when sending jobs to the laser. Everything from resolution to speed and power settings are all located on this one page.



### 1 Resolution

Set your print resolution from 75 to 1200 DPI. For the best engraving results, use a resolution equal to the resolution in the raster images within your project setup. The resolution setting in the print driver will affect the engraving time (there are twice as many engraved lines at 600 DPI as at 300 DPI) and the quality. For a detailed discussion on Resolution, visit **“Resolution” on page 79**.

### 2 Center Engraving

The Center Engraving Option allows you to define the center of your artwork as the primary reference point (Home Position) of your engraving or cutting job. The Center Engraving Option has been designed to be used in conjunction with the Jog feature on the Fusion Control Panel. Center engraving differs from standard printing where the upper left corner of the page and the upper left corner of the laser table define your primary reference point. For more information, visit **“Center Engraving” on page 105** in the manual.

### 3 Rotary Options

Use this check box if you are using the optional 3-Jaw Chuck Rotary Attachment. With this Rotary Attachment you will need to enter the material’s diameter in this selection. See **“3-Jaw Chuck Rotary Attachment” on page 125** for more information.



## 4 Job Manager Features

You can choose to print to either the printer (your Fusion Laser), the Job Manager, or both. This allows you to send your job to the Job Manager without sending it to the laser so you can then print the job directly from the Job Manager at a later time without accessing your graphic software. This is an easy way to set up an entire day's jobs all at one time.

## 5 Laser Type

The same Fusion driver is used to control either the CO2 or the fiber laser depending on your machine configuration. If a function does not apply to the laser type installed in your machine, that function will be grayed out. You'll also see a note reminding you that if you have the Optional Dual Source (CO2 and fiber) laser system, you will need to use Color Mapping if both CO2 and fiber are used in the same project. For more information see "**Setting Up a Dual Source Job**" on page 146.

## 6 Auto Focus

Check this box when you want to use machine's Auto Focus capabilities. Measure the thickness of the material you are using and input the number into the Thickness box. Before the job starts the table will automatically move up or down so that the top of your material is the correct distance from the bottom of the focus lens. If the Auto Focus box is not selected, the table will not move up or down when the job starts.

When the Vector Grid is installed and you want to use Auto Focus, click both the Auto Focus box and the Vector Grid box. This tells the laser system that the Vector Grid is installed and it will automatically compensate for the combined thickness of the grid and your material.

## Offset

Offset allows you to focus at any point above or below the surface of your material. When engraving acrylic many users like to focus above the surface to produce a "softer" finish to the engraving. Conversely, when cutting acrylic, many users like to focus about half way into the acrylic. Offset allows you to do this automatically. A positive value will move the table away from the focus lens. A negative value, such as  $-.095$ , will move the table closer the focus lens.



The material thickness is still required when using the Vector Grid. If a thickness is not specified the system will Auto Focus to the top of the Vector Grid, not to the top of your material. For a detailed discussion on Auto Focus, visit "**Auto Focus vs. Manual Focus**" on page 93.

## 7 Job Type

Choose between the three modes of operation.

- **Raster Mode:** Used for engraving or marking materials. Typical uses include engraving clipart, scanned images, photos, text and graphic images. Vector lines that you want to engrave rather than cut should be set 0.006" (0.152 mm) or greater line thickness.
- **Vector Mode:** Selected when you are running only cut lines or for use with the Red Dot Pointer for previewing the job processing area. For vector mode, a line is recognized as a line to be cut based on the line width (or stroke). These lines can also be affected by resolution. For more information, see "**Setting a Vector Cutting Line**" on page 78. To make things easy, set any cut lines to a line width of 0.001", or hairline width in CorelDRAW.
- **Combined Mode:** Used when you engrave and cut in the same job. The laser will always engrave first, then follow with the vector mode.



**Note on Vectors:** If you are in Vector or Combined mode, all thin lines will be vector cut! This can be disconcerting because even if the lines are not visible in your artwork they will still cut. Usually, this happens when incorporating a clipart image that has hidden lines that are not readily apparent. Please refer to "**Setting a Vector Cutting Line**" on page 78 for an illustrated explanation of how this can affect your work.

## 8 Piece Size

Enter the size of the page you used when creating your artwork. Some laser users prefer to design their piece with a page size matching the page they are engraving, while others prefer to design with the page size set to the full engraving table.

## 9 Raster Settings

**Speed:** Determines the travel speed of the carriage in Raster mode and is adjustable in 1% increments from 1 to 100%. The slower the speed, the deeper the engraving. Speed settings are heavily dependent on the hardness and the thickness of the material being engraved with harder materials requiring slower speeds for deeper engraving. Slower speed settings will produce greater depth of engraving. Please refer to "**Appendix B: Material Settings**" on page 193 in this manual.

**Power:** Determines the amount of laser energy that is delivered to the piece being cut and is adjustable in 1% increments from 1 to 100%. The higher the power, the deeper the engraving. Please refer to "**Appendix B: Material Settings**" on page 193 in the manual.

**Engrave Direction:** This feature applies to raster engraving only and allows you to engrave your project either from the top-down or the bottom-up direction. In standard top-down engraving there can be a large amount of engraving debris generated, especially on materials such as plastic, wood and rubber. As the debris moves toward the exhaust plenum, some of it collects in the area that has just been engraved. Bottom-up engraving prevents the debris from collecting in the freshly engraved spaces.

**Dithering:** This setting defines how the dot patterns will be engraved in raster images that contain grayscale images, blends, or color. The Dashboard offers six different dithering patterns to enhance your engraving projects. The default mode is Standard. This mode can be used for all images, including photographs, but some images improve when engraved with other dithering patterns. Dithering is used only for Raster engraving and has no effect on vector cut lines. For more information, go to “**Image Dithering**” on page 96.

10

## Vector Settings

**Speed:** Determines the travel speed of the carriage in vector cutting mode and is adjustable in 1% increments from 1 to 100%. The slower the speed, the deeper the cut. Most cutting applications require relatively slow speed settings, and the speed is heavily dependent on the hardness and the thickness of the material being cut. Slower speed settings will also produce better edge quality. High speeds are provided for draft mode only and are not intended for production applications. For more information, visit “**Appendix B: Material Settings**” on page 193.

**Power:** Determines the amount of laser energy that is delivered to the piece being cut and is adjustable in 1% increments from 0 to 100%. The higher the power, the deeper the cut. The amount of power necessary to cut completely through a given material is also heavily dependent on the hardness and the thickness of the material. For more information, visit “**Appendix B: Material Settings**” on page 193.

**Frequency:** The number of laser pulses that the laser fires per inch of travel. The frequency is set in the dashboard and can be adjusted from 1 to 100. A lower frequency number will have the effect of less heat because fewer pulses are being used to cut the material. Lower frequency rates are helpful for products like wood, where charring is evident at higher frequencies. High frequencies are useful on materials like acrylic where a large amount of heat is desirable to melt or flame polish the edges.

**Speed Comp:** Reduces all speed settings by one half. For example, a speed setting of 10 without Speed Comp selected will move twice as fast as a setting of 10 with Speed Comp selected. In essence, Speed Comp provides an alternative set of speed parameters that are one half the speed of the standard settings. Speed Comp mode will most often be used with speed settings below 10 when very slow cutting is desired. Most users will rarely use Speed Comp mode, but it creates additional functionality for unusual or demanding applications.

**Power Comp:** When checked Power Comp reduces the laser output when the laser carriage slows as it moves through a curve. Consider it a slow cutting option. Selecting Power Comp is especially useful for vector cutting jobs that incorporate a large number of curves.



Most users find that **keeping Power Comp selected** is the preferred setting.

## Advanced Tab

The advanced tab contains advanced features including 3D, stamp mode and configurations.



### 1 Raster Type

**Basic Mode:** This is the mode you will use for most engraving projects. The laser will use a uniform engraving speed and power for the graphic, providing a consistent engraving.

**3D Mode:** When selected, instead of looking at the dots and determining where to fire the laser based on the dot spacing, we look at the dots and determine how much laser power (wattage) to apply to each dot, allowing us to create a 3D effect when deep engraving in materials like wood. For more information go to **“3D Engraving” on page 161**.

### Stamp Mode

The stamp option automatically converts your artwork into to a format that will produce a laser engraved stamp. This function automatically inverts your artwork so that the background is engraved away while your text and graphic images are left standing. It also puts a supporting shoulder around every component of the artwork.

### 2 Stamp Settings

The stamp option automatically converts your artwork into to a format that will produce a laser engraved stamp. This function automatically inverts your artwork so that the background is engraved away while your text and graphic images are left standing. It also puts a supporting shoulder around every component of the artwork. Because of the unique nature of Stamp mode, we have devoted a sub-section on all aspects of stamp making and printing. Please see **“Rubber Stamps” on page 168** in this manual for detailed instructions on producing and printing

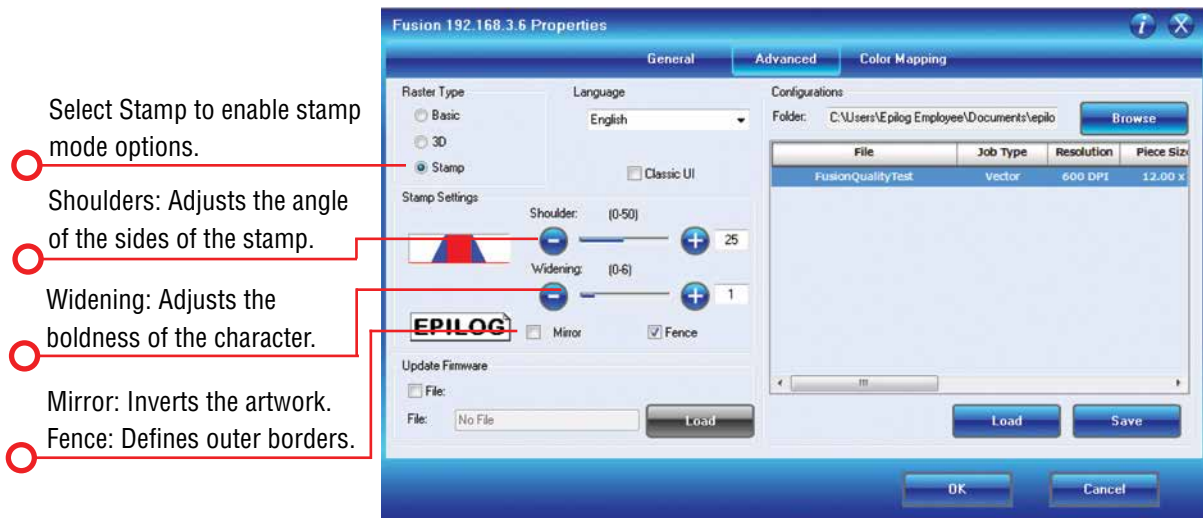

### 3 Update Firmware

When you are ready to update your Fusion firmware, click here and load the file. For more information, visit **“Section : Upgrading the Operational Firmware” on page 155.**

## Configurations

4 The Configurations feature is a comprehensive data management tool that is used to save all of your Dashboard settings for individual jobs. Saving the Dashboard settings as a database file allows you to retrieve the job parameters at a later time. This saves you the trouble of trying to remember what speed and power and other settings you used on a job you did three months ago. All of your settings can all be stored as a permanent record.

For example, in this database we have settings for acrylic, coated steel, glass, and many more. After each configuration file name, you can see if the saved settings are for a Raster, Vector or Combined job, the resolution, and the piece size within that file. To use any of these settings, click the **Load** key.

If you find a setting you would like to save into a new configuration file, simply create the settings within the three Laser Dashboard tabs, then click **Save**.

The Driver Disc has a number of preset configuration files available. When you unzip your selected wattage’s configuration files, they will save to c:/epilog/engraving setting. This is the default folder that the Laser Dashboard will look in to load files available for your laser. After you have found the configuration files you want to use, click on the **General tab** to see the settings that the loaded file brings up.

## Color Mapping Tab

The Color Mapping feature is an advanced feature that must be checked to activate. Color Mapping is designed to be used in either Raster mode or Vector mode, but not in Combined mode. While Color Mapping is a very powerful tool, most operators use it for a few main reasons:



- Using color to define different levels of focus. Many objects need to be marked at different locations that are at different relative heights. Using color mapping to change the focus in a single job setup is a convenient way to make marking complex parts simple.
- Using different colors allows users the ability to sequence the order that objects will be marked.
- Setting different speeds and powers for vector mode. Many users, especially architects, want to score some parts of their artwork and then cut all the way through other parts. Color Mapping allows them to set up unique speed and power settings for each activity, all in a single job setup.

Color Mapping accomplishes these tasks by assigning laser attributes to the different colors in your artwork. The functions that can be controlled by color are: Speed, Power, Frequency, Focus, Raster On/Off, Vector On/Off, Air Assist On/Off. For a detailed look at the Fusion's Color Mapping capabilities, visit "**Color Mapping**" on page 97.

### 1 Enable Color Mapping

When this check box is selected, the laser will use the settings assigned to each color. For any colors that are in your artwork, but not in the color mapping settings, the General settings will be used.

### 2 Adjust Settings

## SECTION 5: USING THE LASER DASHBOARD™

Additional CorelDRAW Laser Dashboard Features

Use the slider bars to create any RGB color and set the laser parameters. Adjusting the settings does not actually change the values. Select the Right Arrow key to finalize the settings.

### 3 Color Map Summary

The Color Map Summary area is located on the right side of the window and offers a visual display of all of the color mapped settings. You can quickly see each color and the speed, power, frequency, focus, mode and Air Assist settings for each of the different colors within your file.

## Additional CorelDRAW Laser Dashboard Features

Each program you use will provide different ways to manage these functions. CorelDRAW offers a very straight forward way to access each of these features.

### Multiple Passes

You can automatically engrave or cut a job multiple times by setting the Number of Copies to the number of passes that you want to make. When each pass is finished the laser will automatically start another pass until all passes are complete.

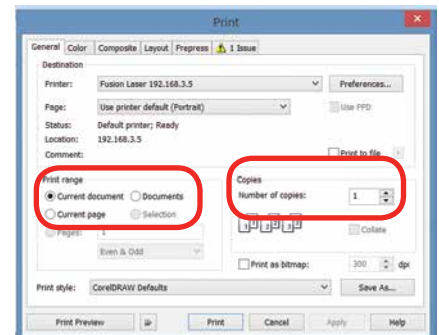

### Print Range

If you only want to print one aspect of your project (for example, just the text in the document), you can select that part of the file, then click Selection and the laser will only engrave or cut that piece of your file.

### Multiple Pages

When you want to engrave multiple pieces within one document, such as five different engraved glass mugs, each with a different name, you can use the Multiple Pages feature of CorelDRAW. Set up each of the mug files on a separate page in your single CorelDRAW file, then when you print to the laser you can choose either **Current document** to print all of the pages or you can specify which pages you want to print by adjusting the settings in the **Print range box**. You can view the different pages in the Print Preview screen.



When a multiple page job is printed to the laser, each of the pages will transfer to the Control Panel with the first file coming across as Job:1. File Name, then Job:2. Page 2, Job: 3. Page 3. Remember, the last page of the job will be the current file when you go to the Fusion's control panel, so scroll back to Job 1: File Name to run that one first.

If you start engraving the jobs and become uncertain about which pages are which, you can refer back to your print preview screen and the Page number in the laser will correspond to the page number in the print preview.





# SECTION 6: USING THE EPILOG MAC DRIVER

## Mac Driver Settings

The Mac Driver is a powerful software tool that allows you to engrave and cut directly to your CO2 Fusion Laser from a Mac. Here we demonstrate how to print from Adobe Illustrator, but there are other graphic software programs you can print from to the laser as well.

### 1 Select Printer

Select your Fusion Laser system as your the printer.

### 2 Options

**Job Type:** Choose between the three modes of operation.

- **Raster Mode:** Used for engraving or marking materials. Typical uses would be reproducing clipart, scanned images, photos, text and graphic images.
- **Vector Mode:** Selected when you are only running cut lines or for use with the Red Dot Pointer for previewing the job processing area. For vector mode, a line is recognized as a line to be cut based on line width (stroke).
- **Combined Mode:** Used when you have both engraving and cutting in the same job. The laser will first engrave your artwork, then follow with the vector mode.

**Center-Center:** The Center Engraving Option allows you to define the center of your artwork as the primary reference point (Home Position) of your engraving or cutting. The Center Engraving option has been designed to be used in conjunction with the Jog feature on the Fusion Control Panel. Center engraving differs from standard printing where the upper left corner of the page and the upper left corner of the laser table define your primary reference point. For more information, visit “**Center Engraving**” on page 105 in the manual.

**Auto Focus:** Check this box when you want to use machine’s Auto Focus capabilities. Measure the thickness of the material you are using and input the number into the thickness box. The table will automatically move up or down so that the top of your material is 2” (50.8 mm) from the bottom of the focus lens. If the Auto Focus box is not selected, Auto Focus will be disabled and the table will not move up or down when the job starts.

When the Vector Cutting Table is installed and you want to use Auto Focus, click both the Auto Focus box and the Vector Grid box. This tells the laser system that the Vector Cutting Table is installed and it will automatically calculate the appropriate focal distance based on this information.

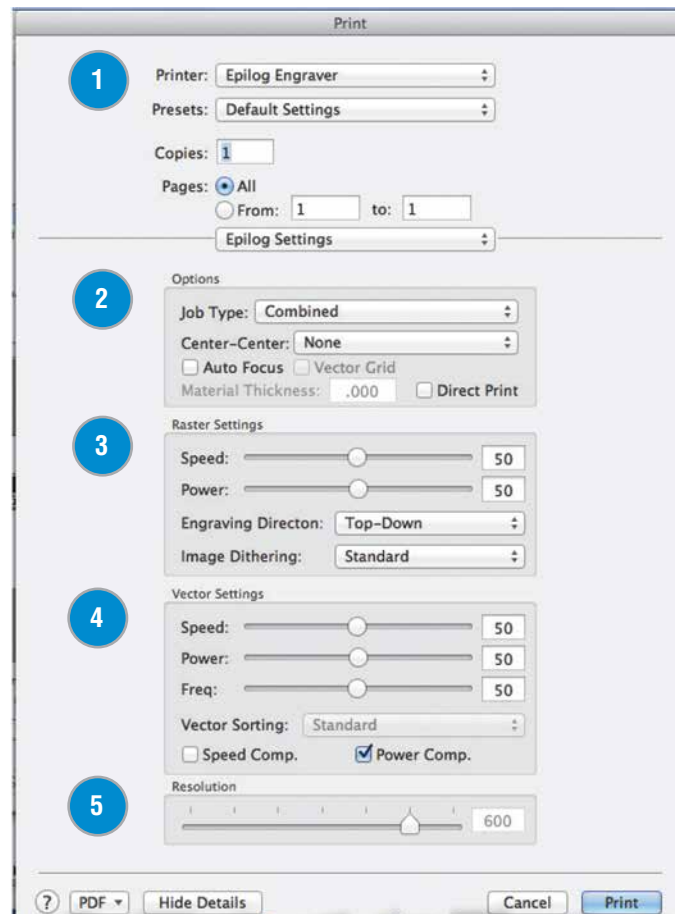



The material thickness is still required when using the Vector Cutting Table. If a thickness is not specified the system will Auto Focus to the top of the Vector Cutting Table, not to the top of your material. For a detailed discussion on focusing the laser, visit “**Auto Focus vs. Manual Focus**” on page 93.

**Direct Print:** The direct print check box is for use only when you want to send a job directly to the engraver without first going through the Epilog Viewer.

### 3 Raster Settings

**Speed:** Determines the travel speed of the carriage in Raster mode and is adjustable in 1% increments from 0 to 100%. The slower the speed, the deeper the engraving. Speed settings are heavily dependent on the hardness and the thickness of the material being engraved with harder materials requiring slower speeds for deeper engraving. Slower speed settings will produce greater depth of engraving. Please refer to “**Appendix B: Material Settings**” on page 193 in this manual.

**Power:** Determines the amount of laser energy that is delivered to the piece being cut and is adjustable in 1% increments from 1 to 100%. The higher the power, the deeper the engraving. Please refer to “**Appendix B: Material Settings**” on page 193 in the manual.

**Engraving Direction:** This feature applies to raster engraving only and allows you to engrave your project either from the top-down or the bottom-up direction. In standard top-down engraving there can be a large amount of engraving debris generated, especially on materials such as plastic, wood and rubber. As the debris moves towards the exhaust plenum, some of it collects in the area that has just been engraved. Bottom-up engraving prevents the debris from collecting in the freshly engraved spaces.

**Dithering:** This setting defines how the dot patterns will be engraved in raster images that contain grayscale images, blends, or color. The Dashboard offers six different dithering patterns to enhance your engraving projects. The

default mode is Standard. This mode can be used for all images, including photographs, but some images improve when engraved with other dithering patterns. Dithering is used only for Raster engraving and has no effect on vector cut lines. For more information, go to “**Image Dithering**” on page 96.

### 4 Vector Settings

**Speed:** Determines the travel speed of the carriage in Vector cutting mode and is adjustable in 1% increments from 1 to 100%. The slower the speed, the deeper the cut. Most cutting applications require relatively slow speed settings, and the speed is heavily dependent on the hardness and the thickness of the material being cut. Slower speed settings will also produce better edge quality. High speeds are provided for draft mode only and are not intended for production applications. For more information, visit “**Appendix B: Material Settings**” on page 193.

**Power:** Determines the amount of laser energy that is delivered to the piece being cut and is adjustable in 1% increments from 0 to 100%. The higher the power, the deeper the cut. The amount of power necessary to cut completely through a given material is also heavily dependent on the hardness and the thickness of the material. For more information, visit “**Appendix B: Material Settings**” on page 193.

**Freq:** The Frequency is the number of laser pulses that the laser fires per inch of travel. The frequency is set in the dashboard and can be adjusted from 1 to 100. A lower frequency number will have the effect of less heat because fewer pulses are being used to cut the material. Lower frequency rates are helpful for products like wood where charring is evident at higher frequencies. High frequencies are useful on material like acrylic where a large amount of heat is desirable to melt or flame polish the edges.

**Speed Comp:** Reduces all speed settings by ½. For example, a speed setting of 10 without Speed Comp selected will move twice as fast as a setting of 10 with Speed Comp selected. In essence, Speed Comp provides

## SECTION 6: USING THE EPILOG MAC DRIVER

an alternative set of speed parameters that are ½ the speed of the standard settings. Speed Comp mode will most often be used with speed settings below 10 when very slow cutting is desired. Most users will rarely use Speed Comp mode, but it adds additional functionality for unusual or demanding applications.

**Power Comp:** When checked, power compensation reduces the laser output when the laser carriage slows as it moves through a curve. Selecting Power Comp is especially useful for vector cutting jobs that incorporate a large number of curves. This has the effect of producing unparalleled edge quality when cutting curves. Most users find that keeping Power Comp selected is the preferred setting.

### 5 Resolution

Set your print resolution from 75 to 1200 DPI. For the best engraving results, use a resolution equal to the resolution in the raster images within your project setup. The resolution setting in the print driver will affect the engraving time (there are twice as many engraved lines at 600 DPI as at 300 DPI) and the quality. For a detailed discussion, visit “**Resolution**” on page 79.

# SECTION 6: USING THE EPILOG MAC DRIVER

## Project Setup

While the Mac Driver will work with many different graphic software packages, we'll be looking at Adobe Illustrator for this example.

1. Click the Epilog icon to open the Epilog Viewer.

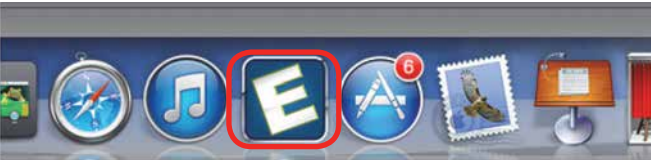

2. In this example, we'll set up an Aztec Calendar engraving and cutting project. We've set up our graphic on our page and are ready to select **File/Print**.

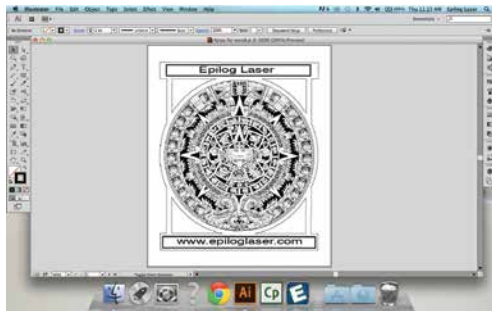

3. The standard Illustrator print window will come up, which will be different depending on which version of Mac OS you are using. Set your **Printer to Epilog Engraver** and **PPD to Default (Epilog PDE)**. Click **Setup** to access the laser settings.

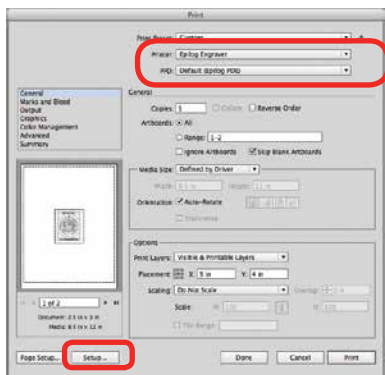

4. Click on the **Layout** drop-down menu and select **Epilog Settings**.

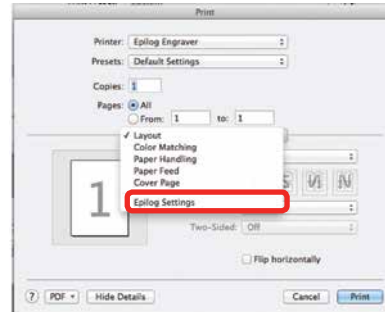

5. Set your laser **Settings**. We've set our Job Type to **Combined** because we'll be both engraving and cutting in this job. For Raster Settings, we've used **50% speed, 100% power**. For Vector Settings, we've used **30% speed, 70% power**. Finally, our resolution has been set to **600 DPI**.

When you have your settings how you'd like them, choose **Print**.

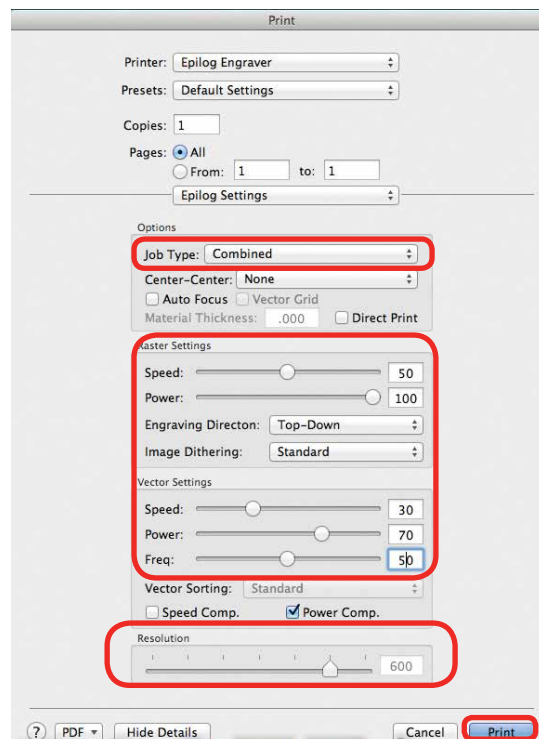

# SECTION 6: USING THE EPILOG MAC DRIVER

Vector Cutting Lines

6. You will return to this print window, so click **Print**.

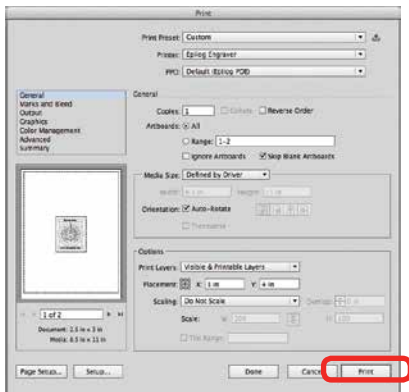

7. The driver will now transfer the job to the Epilog Viewer. The **Epilog Transfer icon** will appear in the Dock. The transfer will take several seconds.



8. Once the Epilog Transfer Icon disappears, the **Epilog Viewer Icon** will bounce up and down and you can **click on the icon** to access the Epilog Viewer.



It's important that the Epilog Viewer is open before printing. If it is not open, pause the transfer in the processing window, open the Epilog Viewer, and restart the transfer.



9. In the Epilog Viewer, click **Edit Settings** if you want to change any print settings, or click **Print** if the job is ready to send to the laser.

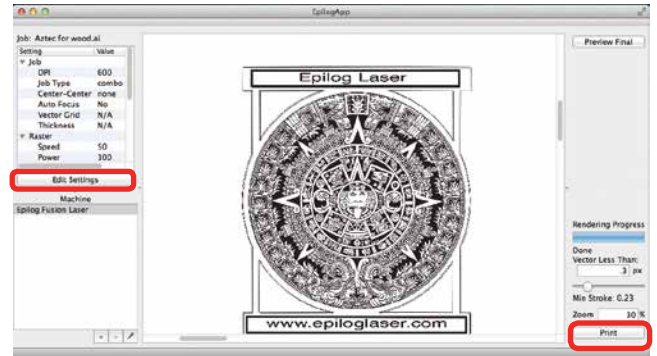

## Vector Cutting Lines

1. Unlike Windows, the Mac Driver allows you to set the line width that will be cut in the driver. For this file we have some lines that will be engraved and some that will be cut. The cut lines we set to 0.23 pixels, while the engraved lines we set to 1 pixel width.
2. At the bottom right corner of the screen type **.3** in the Vector Less Than box. This will cut any line that is less than .3 pixels in width and engrave any above that amount.



## SECTION 6: USING THE EPILOG MAC DRIVER

3. To see which lines will be cut, click **Preview Final**. In the Epilog Viewer, you can see which lines are vectors and ready to be cut. Click on Preview Final and the vector lines less than 1 px will be shown in red.

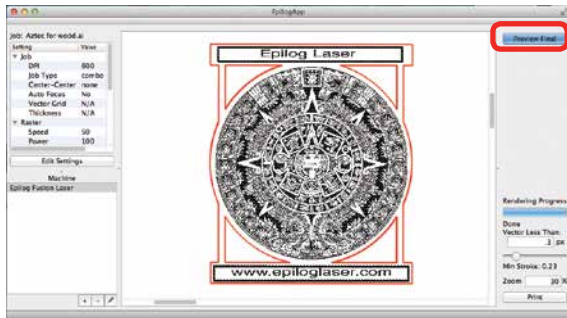

# SECTION 7: FUSION CONTROL PANEL

Display

## Display

The display shows valuable information associated with the highlighted Functional Menu items. We will explain the different information that will be displayed as we go through the description of each menu item.

### International Symbolic Version:

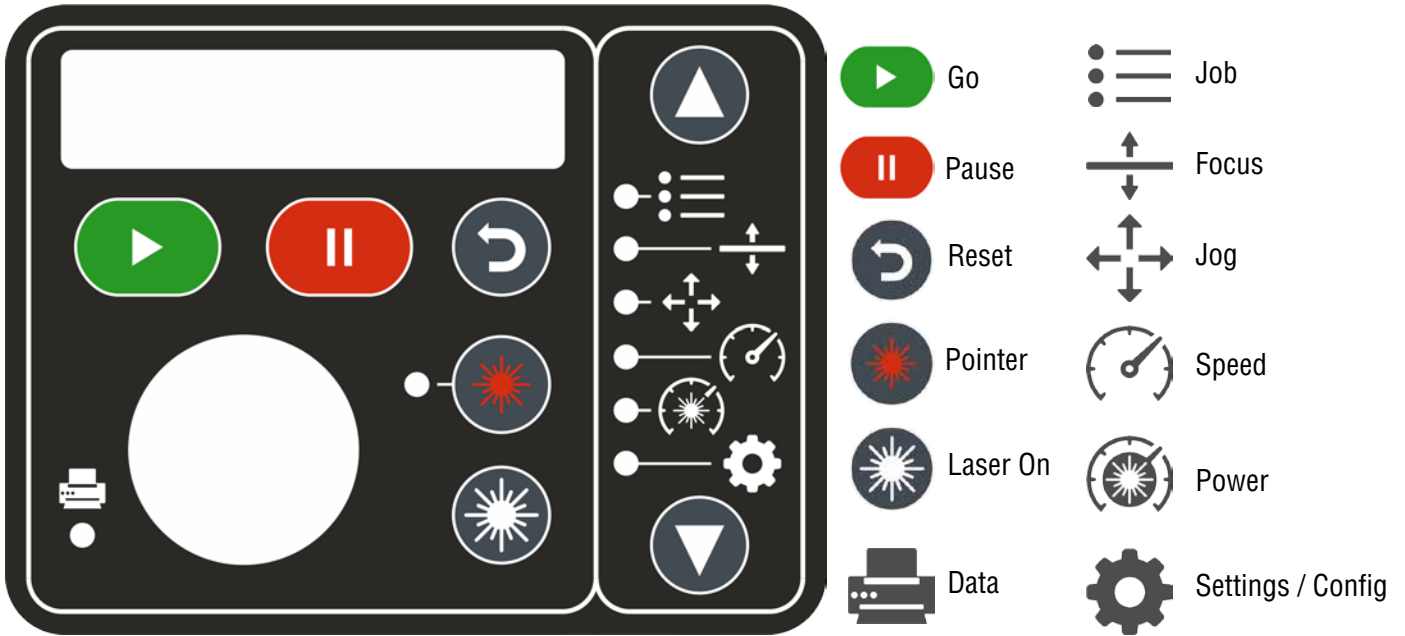

### US English Version:

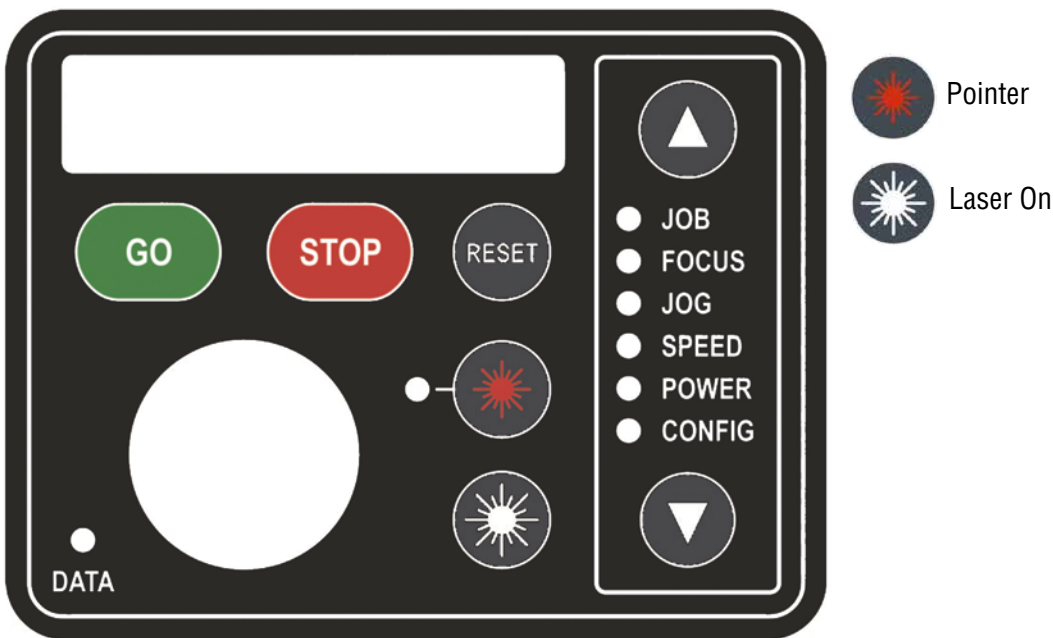

## Go Button

- Press the Go key to start or resume a job.

## Pause / Stop Button

- Pressing the Pause key will stop the lens carriage and the laser beam will be shut off. If the Pause key is pressed during raster engraving mode the lens carriage will pause on either the far left or far right of the engraving line that is in process. If the Pause key is pressed while in vector cutting mode, the lens carriage will stop at the end of a line segment or at the next line node location.
- Once the lens carriage has stopped, you can open the door to examine the engraving. By closing the door and pressing the Pause key, the engraving/cutting job will commence where it left off. If the item being engraved is not moved the engraving/cutting registration will not be affected.
-  **Note:** Opening the door on the laser during engraving or cutting will stop the laser from firing; however, the lens carriage will continue to move. It is important to stop the job before you open the door to insure the engraving/cutting is completed.
- If you press the Pause key while in vector mode it may take some time for the system to actually stop. The system needs to get to the next node in a vector before it can stop.

## Reset Button

- Pressing the Reset key will move the carriage back to its Home Position. Press the Reset key after you have pressed the Pause key, or after you have moved the carriage when in the Jog position.
- Reset does not erase the job from the laser systems memory; rather it will stop the engraving job in process and send the carriage back to the Home Position.

## Data Transferring

This light will illuminate when data is being passed to the laser. This is a handy tool when you are checking to see if your laser is connected to your computer.

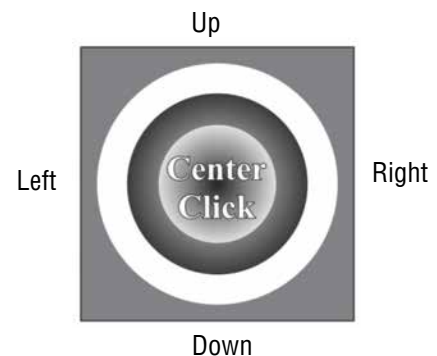



### Pointer

The Pointer key is a toggle switch that turns the laser system's Red Dot Pointer on and off. When the Red Dot Pointer is on, the indicator light directly to the left of the pointer key will be illuminated. For more information visit "**Red Dot Pointer**" on page **103**.

### Laser On

The Laser On key allows you to move the carriage and fire the laser without having a job in the display. This is a very handy feature because it allows you to do simple tasks without printing a job to the laser system.

To use the Laser On feature you must be in Jog mode, with the door closed. When in Jog mode, press and hold the white Laser On key. Simultaneously use the Joystick to move the carriage. When the carriage moves, the laser will fire. As soon as the carriage stops moving the laser will stop firing.

You can adjust the default laser power being used in Laser On mode from the Settings menu. Highlight Settings, then use the Joystick to scroll down to Jog Laser PWR. Center click the Joystick and then tilt the Joystick Up or Down to change the value. Press the Go key to activate the change. Go back to Jog mode to use Laser On.

### Job

- The Jobs selection allows you to use the Joystick to scroll through the jobs in your laser system. You will be able to see the job in the first line of the display. The estimated job time and the print resolution will also show on the second line of the display.
- The job name displayed is the same name as the file name that you printed to the laser.
- When the job you want has been selected, press the Go key in the action keys to start the job.
- After the job starts, the job timer in will be activated and will be shown on the second line of the display.

## Focus

The Focus selection allows you to manually set the table to the correct height for engraving. With Focus highlighted, use the Joystick to move the table up or down. The display will show a digital readout of the table position.

The image below also shows two visual indicators that provide addition functionality to the Focus function:

- The two arrows on the left side of the second line in the display indicate whether you are in “Course” or “Fine” focus mode. In Course mode the table will move up or down in large increments. In Fine mode the table will move up or down in small increments.
- Tilt the Joystick left or right to toggle between fine and course movements.

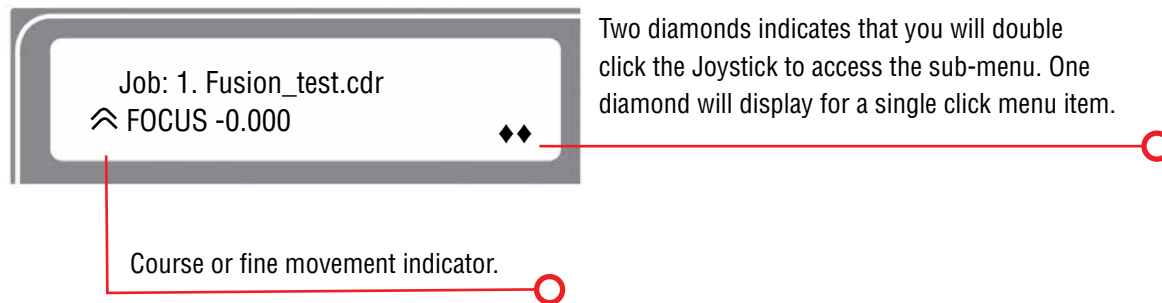

## Focus Sub-Menu: New Z-Axis Home Position

The two diamonds on the bottom right of the display indicate that by double center clicking the Joystick you will bring up a sub-menu that will allow you to set a new or temporary table z-axis Home Position. To set a new Home Position, first move the table up or down in the focus menu, then double click the Joystick at bring up the sub-menu:



- **Up (Go):** Tilt the Joystick up to move the table to its default zero/zero Home Position.
- **Down (Moveout):** Tilt the Joystick down to move the lens carriage out from its upper, left corner position by about 2” (50 mm).

- **Left (Set):** Tilt the Joystick to the left to set a new or temporary z-axis Home Position.



**Note:** The SET 0 function is only used to set or reset a new or temporary Home Position for your table height when using the Color Mapping function in the Dashboard driver. Auto Focus will not work properly once a new 0 (zero) table Home Position has been established.

When you set a new 0 (Zero) position for your table, the Auto Focus function in the driver will no longer reference the default table height. It will reference the new Table Home Position, rendering Auto Focus useless.

You must RESTORE Table Home to re-establish the default Table Home Position if you want to start using Auto Focus again.

- **Right (Restore):** Tilt the Joystick to the right to restore the table height to its default Home Position. This is normally done when you are finished with your new or temporary Table Home Position and want the table to move back to its default Home Position so you can start using Auto Focus again.



**Note:** An alternative method of setting a new Table Home Position is to just center click once while in the Focus Menu. There is no visual indicator on the display, but a single center click after you have focused your table eliminates double center clicking to access the sub-menu.

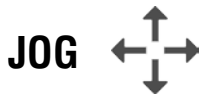

The Jog function allows you to move the laser head around the table with the use of the Joystick. To make it easier to use, turn on the Red Dot Pointer for a visual indicator of where the carriage is moving. The carriage can be moved in X, Y or diagonally. The display will show a digital readout of the carriage position.

## Jog Sub-Menu: Setting a New X/Y Axis Home Position

The Jog function is most useful for setting a new or temporary Home Position when working on odd shaped items or if it's just more convenient to designate somewhere other than the upper left corner of the table as your starting point. To set a new Home Position, use the following instructions:

1. Go to the **Jog** function on the Control Panel.
2. Use the **Joystick** to move the carriage to a new position. Use the **Red Dot Pointer** as a visual indicator of the carriage location. The display will also show a digital readout of the X and Y position.
3. Double center click to access the sub-menu:
  - **Up (Go):** Tilt the Joystick up to move the carriage back to its zero/zero position. This function will move the lens carriage back to a new or temporary Home Position.
  - **Down (Exit):** Tilt the Joystick down to exit the sub-menu. Center clicking does the same thing.

## SECTION 7: FUSION CONTROL PANEL

Display

- **Left (Set):** Tilt the Joystick left to set a temporary (new) XY Home Position.
- **Right (Restore):** Tilt the Joystick to the right to reset the lens carriage back to its upper left corner position after you are finished using a new or temporary Home Position.

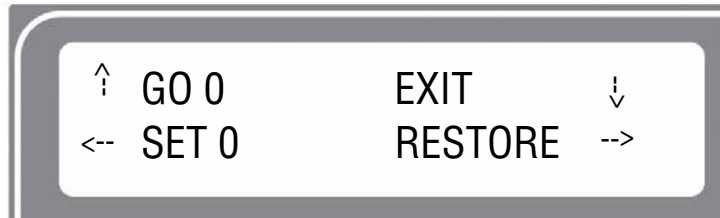

**Note:** An alternative method of setting a new Home Position is to just center click once while in the Jog menu. There is no visual indicator on the display, but a single center click eliminates the need to access a sub-menu.

### Speed



With Speed highlighted, the speed setting will be displayed. The display will show RS for Raster Speed and VS for Vector Speed.

### Power



With Power highlighted, the power setting will be displayed. The display will show RP for Raster Power and VP for Vector Power.

### Settings/Config



With Settings highlighted, use the Joystick to scroll through the available menu items.

There are two different modes of operation in the Settings menu:

- **Functions:** Any menu item with a diamond (◆) in front of it is a function. Simply center click on the Joystick to perform that function.
- **Adjustment (Calibrations):** These are menu items that can be changed. There is not a diamond in front of these items, but center clicking is used to allow access to the function. After center clicking to gain access, use the Joystick to increment, decrement or toggle the value that is shown. Press the Go key to make your change permanent.

The items in the Settings menu are shown below along with a description of how they are used:

1. ◆ **Restore XY Home:** Center click to restore the lens carriage to its standard Home Position when you are finished using a temporary Home Position. You can Restore XY Home from here or you can double center click in Jog mode to do the same thing.

## SECTION 7: FUSION CONTROL PANEL

Display

2. ♦ **Restore Table Home:** Center click to send the table back to its default Home height. You can Restore Table Home from here or you can double center click in Focus mode to do the same thing.
3. **X Home:** This is a calibration function that insures your artwork is properly located on the table in the X-axis. It is set relative to the upper left corner of the table and the readout shows increments of .001" (.025 mm).
  - **Center click** to gain access, **tilt the Joystick** up or down to increment or decrement. Press the **Go** key to make your change permanent. These settings will not go into effect until you **Restore Table Home** (see above) or turn off the system.
  - **Increasing** this number has the effect of moving your artwork to the **right**. If you increase the value from -123 to -121 will move the X Home to the right by .002" (.051 mm).
  - **Decreasing** this number has the effect of moving your artwork to the **left**.
4. **Y Home:** This is a calibration function that insures your artwork is properly located on the table in the Y-axis. It is set relative to the upper left corner of the table and the readout shows increments of .001" (.025 mm).
  - **Center click** to gain access, **tilt the Joystick** up or down to increment or decrement. Press the **Go** key to make your change permanent. These settings will not go into effect until you **Restore Table Home** (see above) or turn off the system.
  - **Increasing** this number has the effect of moving your artwork **down**.
  - **Decreasing** this number has the effect of moving your artwork **up**. If you decrease the value from 23 to 20 you will move the Y Home up by .003" (.076 mm).
5. **Table Home:** This is a calibration function that insures your Auto Focus distance is set properly. It establishes the correct spacing between the focus lens and the top of the table. It insures that the table always moves the top of your work piece to a point that is exactly two inches below the focus lens (or, three inches for the Fiber lens) when Auto Focus is used. The readout shows increments of .001" (.025 mm).
  - **Center click** to gain access, **tilt the Joystick** up or down to increment or decrement. Press the **Go** key to make your change permanent.
  - **Increasing** this number has the effect of **increasing** the distance between the table and the lens carriage.
  - **Decreasing** this number has the effect of **decreasing** the distance between the table and the lens carriage.
6. **Fiber Offset:** This is a setting found on Fusion M2 systems that have both CO2 and fiber lasers installed. This setting is a factory installed setting.
7. **Vector Grid Home:** A calibration for adjusting the Z-Home Position of the Vector Grid when installed.
8. **Jog Laser PWR:** This function sets the laser power that will be used when using the Laser On feature. Increasing this number increases the percentage of the laser power that will be used when Jogging the lens carriage and pressing the white Laser On key.
  - **Center click** to gain access, **tilt the Joystick** up or down to increment or decrement. Press the **Go** key to make your change permanent.
9. ♦ **Quick Table Home:** A center click will move the table down to find the nearest table height sensor. This function is rarely used.

## SECTION 7: FUSION CONTROL PANEL

Display

10. **Serial #:** This establishes a serial number for USB use. Center click to gain access, tilt the Joystick up or down to increment or decrement. Press the Go key to make your change permanent. This function is rarely used.
11. **IP Address:** This sets the IP Address of the laser system. **Center click** to gain access, **tilt the Joystick** up or down to increment or decrement. Tilt left or right to move to the different sets of three numbers. Press the **Go** key to make your change permanent.
12. **Subnet Mask:** This sets the Subnet mask for the laser system. **Center click** to gain access, **tilt the Joystick** up or down to increment or decrement. **Tilt left or right** to move to the different sets of three numbers. Press the **Go** key to make your change permanent.
13. **Gateway:** This sets the Gateway for the laser system. **Center click** to gain access, **tilt the Joystick** up or down to increment or decrement. **Tilt left or right** to move to the different sets of three numbers. Press the **Go** key to make your change permanent.
14. **Laser Installed:** This is a factory setting that is not user accessible and shows which type laser is installed in the machine - CO2, Fiber, or both. CO2 lasers are the most versatile and work with many different types of materials. Fiber lasers are used for metal marking only.
15. **Vector Grid In:** This indicates if the Vector Cutting Table is installed. **Center click** to gain access, **tilt the Joystick** up or down to toggle between Yes and No. Press the **Go** key to make your change permanent.
16. **AirA Raster:** This tells the machine to activate Air Assist during all Raster jobs. **Center click** to gain access, **tilt the Joystick** up or down to toggle between Yes and No. Press the **Go** key to make your change permanent.
17. **AirA Vector:** This tells the machine to activate Air Assist during all Vector jobs. Center click to gain access, tilt the Joystick up or down to toggle between Yes and No. Press the Go key to make your change permanent.
18. **CO2 Laser Match:** This sets the left-right raster line alignment for the CO2 laser. This setting is normally a factory only setting and will not need to be adjusted by the user.
19. **Fiber Laser Match:** This sets the left-right raster line alignment for the fiber laser. This setting is normally a factory only setting and will not need to be adjusted by the user.
20. **◆ Set XY Home:** This sets a new Home Position. Most users find it is easier to make this setting from the sub-menu in Jog mode.
21. **◆ Set Table Home:** This sets a new Table Home Position. Most users find it is easier to make this setting from the sub-menu in Focus mode.
22. **◆ Go XY Home:** This restores the carriage lens to its default Home Position in the upper left corner of the machine. Most users find it is easier to make this setting from the sub-menu in Jog mode.
23. **Auto Delete:** This setting allows you to have jobs automatically delete after running. You will typically want to have this setting turned to No.
24. **◆ Go Table Home:** This restores the table to its default Home Position.
25. **X Scale Adjust:** This setting calibrates the accuracy in the X-axis. This setting is normally a factory only setting and will not need to be adjusted by the user.
26. **Y Scale Adjust:** This setting calibrates the accuracy in the Y-axis. This setting is normally a factory only setting and will not need to be adjusted by the user.

## SECTION 7: FUSION CONTROL PANEL

Display

27. **Laser TI:** This sets the Tickle of the laser tube. This setting is normally a factory only setting and will not need to be adjusted by the user.
28. **Pulse Stretch:** This sets the Pulse Stretch of the laser tube. This setting is normally a factory only setting and will not need to be adjusted by the user.
29. **Table Speed Adj:** This adjusts the speed of the table and is normally a factory only setting that should not be adjusted by the user.
30. **Bed Size:** This indicates the bed size. This setting is normally a factory only setting and will not need to be adjusted by the user.
31. **System Unit:** Sets the units of the machine to inches or millimeters.
32. **Fiber Laser Power:** This the wattage of the fiber laser source and should not be changed by the user.
33. **◆ Full Table Home:** This setting resets all temporary Home Positions and reestablishes the default Home Position that is found at boot up.
34. **Raster Tune Adj:** This fine tunes raster engraving mode and is normally a factory only setting that should not be adjusted by the user.
35. **Vector Tune Adj:** This fine tunes the vector cutting mode and is normally a factory only setting that should not be adjusted by the user.
36. **Calibrate Joystick:** This setting is normally a factory only setting. It reestablishes the feel of the Joystick.
37. **Rotary Installed:** This displays if a Rotary Attachment is currently installed.
38. **Rotary Version:** This displays the Rotary version that is installed.
39. **Y Drive Version:** This displays the Y Drive version that is installed.
40. **X Drive Version:** This displays the X Drive version that is installed.
41. **Passcode:** The passcode feature on the Fusion laser allows you to create a passcode to lock the factory set machine functions within the Settings menu so they cannot be changed accidentally.

### To Establish a Passcode:

- Go to the Settings menu on the Fusion Keypad and tilt the Joystick up until you see Passcode 0000.
- Center click the Joystick to gain access and show the cursor.
- Tilt the Joystick up or down to increment or decrement the first number. Tilt the Joystick left or right to increment or decrement the next number. Continue the process until you have set a four-digit Passcode number.
- Write down your Passcode and save it in a secure place!
- Press the Go key to exit and display your Passcode.
- To finalize the lock process, tilt the Joystick down while still in the Settings menu until you see the Lock Config menu item.

- Center click the Joystick.
- Press Go to lock the code or Pause to exit the menu.
- After locking the Passcode, access to all machine factory settings from within the Settings menu will be visible, but will be locked out so they cannot be changed accidentally.
- Machine functions such as Restore XY Home, Quick Table Home, etc will not be locked out and can still be used from the Settings menu.

### Verify the Settings/Config Menu Has Been Locked

- To verify that your Passcode has been locked, tilt the Joystick Up until the menu reads Passcode XXXX.

### Disable Your Passcode

- Go to the Settings Menu on the Fusion Keypad.
- Tilt the Joystick Up to the Unlock Config menu item.
- Center click the Joystick to gain access and display the cursor.
- Tilt the Joystick Up, Down, Left and Right to enter your Passcode.
- Press the Go key. Your Passcode will now be displayed, but it has been unlocked.
- Your Fusion is unlocked any time you can read the four-digit Passcode.
- Your Fusion is locked any time the Passcode reads XXXX.

42. **◆ Lock Config:** Locks and unlocks the Settings/Config menu in conjunction with the Passcode (see above).

43. **System Version:** This displays the Firmware version that is installed.

## Joystick

The Joystick is used to control, move, or change all of the available features found in the Fusion Control Panel. After you highlight a Function Menu item you will use the Joystick to control, move or change that function by tilting or depressing the Joystick.

Changes made while using the Joystick will be shown on the two-line LCD display. The Joystick is an extremely versatile tool that can be used in many different ways.

There are four primary functions to control the Joystick:

- **Tilting:** Many actions will be performed by tilting the Joystick from side-to-side or up and down. The Joystick provides 360 degrees of maneuverability. The Joystick is progressive in that a slight tilt will produce a small or slow movement while a greater tilt will produce a faster or larger movement.



## SECTION 7: FUSION CONTROL PANEL

Job Storage: Temporary Memory

- **Center Click:** This is accomplished by simply pressing straight down on the center of the Joystick. A special ♦ character is used in the display to indicate functions where a center click action is used. For example, use the cursor keys on the Control Panel to scroll to the Settings function. The first setting will read ♦ Restore XY Home. The diamond that is in front of Restore XY Home indicates that a center click will restore your lens carriage to the upper left Home Position.
- **Double Center Clicking:** A double diamond ♦ ♦ in the lower right corner of the display indicates that a sub-menu is available when a double center click is initiated. The Focus and Jog functions both provide a sub-menu when a double center click is used.
- **Flick:** A single, quick “flick” will produce a single movement or very small adjustment.

The Joystick is progressive and touch sensitive and provides a continuously variable range of adjustments. It is sensitive to the degree of tilt that is being applied. The more you tilt the Joystick, the bigger your impact on the function you are using.

### Now you try it!

1. Use the cursor keys on the Control Panel to highlight the Jog function. Jog mode moves the lens carriage. Now, simply tilt the Joystick as far as you can to the right and down. The lens carriage will start moving, slowly at first, then after a second it will start picking up speed. To slow the carriage, simply reduce the amount of tilt you apply to the Joystick. Varying the amount of tilt changes how fast the carriage moves.
2. Now, let's “flick” the Joystick. By flicking the Joystick, the carriage will move about .001” or .002”. You will probably not be able to see the motion, but if you watch the display panel you will see that the digital readout changes.
3. Once you get a feel for it, you will be able to move the carriage at an absolute crawl or as fast as it will go just by adjusting the amount of tilt.

### Job Storage: Temporary Memory

While there is no key for this, the Fusion laser has the capability to store multiple jobs in temporary memory. The machine will store any and all jobs sent until there is no free temporary memory left. For all practical purposes, there is no limit to the number of jobs you can send to the laser.



**Note:** Temporary jobs stored in the laser systems will be erased when the laser system is turned off. For permanent job saving, print the file to the Job Manager, where you can file the job for later retrieval along with all settings you used in the past.



# SECTION 8: QUICK START GUIDE

## Artwork Setup

Create your job in the graphics software of your choice, such as CorelDraw or Adobe Illustrator. There are three different modes of operation for the laser and the way you setup your artwork will determine if you raster engrave, vector cut, or use combined mode.

### Raster Engraving

Raster engraving can best be described as very high resolution dot matrix “printing” with a laser. Raster engraving is used to create highly detailed graphic images. The laser head scans back and forth, left to right, engraving a series of dots one line at a time. As the laser head moves down line by line, the dot pattern forms the image that was printed from your computer. You can raster engrave scanned images, text, clipart, photographs, or line drawings.

This artwork is a good representation of a raster file. The photograph of the tiger will raster engrave, as will the text that has been placed on the page.



### Vector Cutting

When you are vector cutting, the laser is following a continuous path that follows the outline, or profile, of an image. Vector cutting is normally used to cut completely through materials such as wood, acrylic, paper, etc. It can also be used for quick marking of characters and geometric patterns. You can vector cut with the laser by setting objects and text to be unfilled and drawn with a 0.001” (0.025 mm) outline. The thin outline will produce a vector cut.

This graphic shows a vector image made up of lines. You can tell it is a vector image because you can individually select any of the lines and manipulate that part of the graphic.



When vector cutting, we always suggest that you use the Vector Cutting Table or Pin Table to protect the back of your material as well as your table from laser marking.

## SECTION 8: QUICK START GUIDE



**Note:** If your raster artwork contains thin lines between .001" (.025 mm) and .007" (.177 mm) depending on resolution, and you are using Vector or Combined mode, those thin lines will all vector cut. The most common setup where this occurs is when you have a clipart image with hidden lines that you send to the laser using Combined mode. The artwork shown below is a good example of a piece of clipart as it appears on the screen (top) and the hidden lines (bottom) that will vector cut if you are in Combined or Vector mode. If you only want to raster engrave, make sure you select Raster mode in the Epilog Dashboard.

In CorelDraw you can view just the lines (bottom view) by clicking on the **View** key in the menu bar and selecting **Simple Wire Frame**. The upper image is a complex piece of clipart. The lower image shows all of the hidden lines that are in this piece of clipart. If this clipart image were run in Combined mode, it would first raster engrave most of the car then vector cut any of the thin lines below .007" (.177 mm). You can also use the Preview function of the Epilog Job Manager to view only vector lines. See **"Previewing Your Job" on page 39**.



Clipart that looks like it is a raster file is actually often made up of small lines. If the lines are set too thin, then it may cut as well as engrave if you send it to the laser in combined mode.

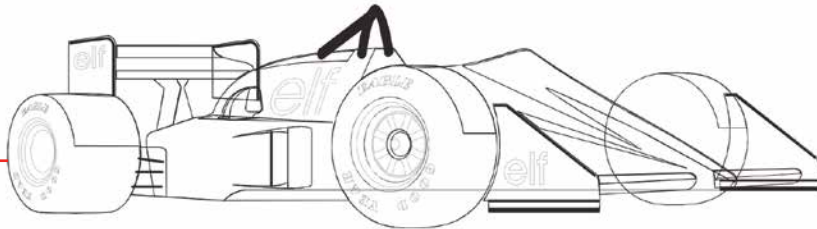

## Setting a Vector Cutting Line

The laser determines which lines to engrave or cut based on the width (stroke) of each line. If you're using CorelDRAW, any line set to hairline width will cut. But in other software what width should you set a line to? Different line weights will engrave and cut at different widths and resolutions.

The table below shows various line widths and which will cut at the different resolutions. To be safe, set all vector lines to .004" (.101 mm) or less to make sure they will always cut.

Line Width	150 DPI	200 DPI	300 DPI	400 DPI	600 DPI	1200 DPI
.001" (.025 mm)	Cut	Cut	Cut	Cut	Cut	Cut
.002 (.058 mm)	Cut	Cut	Cut	Cut	Cut	Cut
.003 (.076 mm)	Cut	Cut	Cut	Cut	Cut	Cut
.004 (.101 mm)	Cut	Cut	Cut	Cut	Cut	Cut
.005 (.127 mm)	Cut	Cut	Cut	Engrave	Engrave	Engrave
.006 (.152 mm)	Cut	Cut	Cut	Engrave	Engrave	Engrave
.007 (.177 mm)	Cut	Cut	Engrave	Engrave	Engrave	Engrave

## Where do I set the Vector Line Width?

Different software packages set the line width in different places. In CorelDRAW, you can find the outline width in the top menu bar when a vector line is selected. In Adobe Illustrator it is called the stroke width and you can find this setting in the Stroke Panel.



If you can't select a line to set the width, it may be because it is part of a grouped object. Try to ungroup the object, then select the line. You also can't select an individual line if that line is part of a raster image.

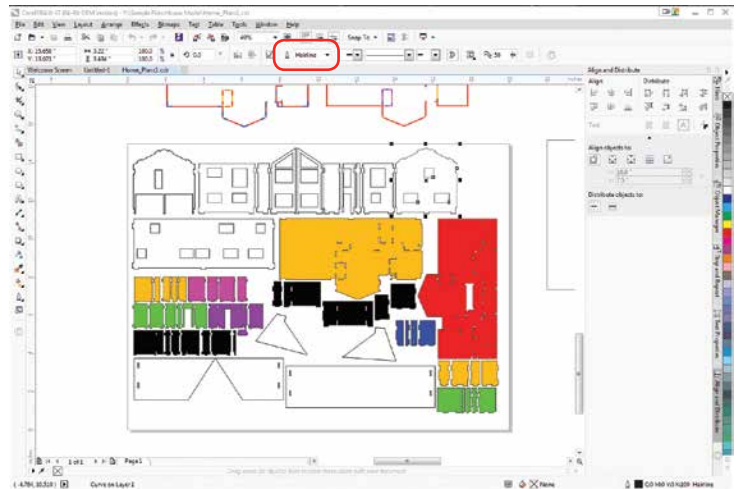

## Resolution

Print quality is commonly referred to as Resolution and is one of the variables that determine image quality. Resolution is expressed in dots per inch (DPI) and is determined by the number of lines or dots that are engraved for every inch of movement. Each horizontal line is referred to as a raster line. The higher the resolution setting, the finer the detail that can be achieved. Keep in mind that engraving resolution is only one factor in determining image quality. The quality of the artwork being sent to the laser can have a bigger influence on the look of the final product than the resolution. If low quality artwork is being used, even the highest resolution will not improve it. Also keep in mind that image quality is subjective. 300 DPI may be just fine for some images and some customers, while 600 DPI is the absolute minimum for others.

This diagram shows the concept of raster lines and dots-per-inch (DPI). The arrows show the change in direction of the carriage between raster lines. The difference in dot density between 300 DPI and 600 DPI.

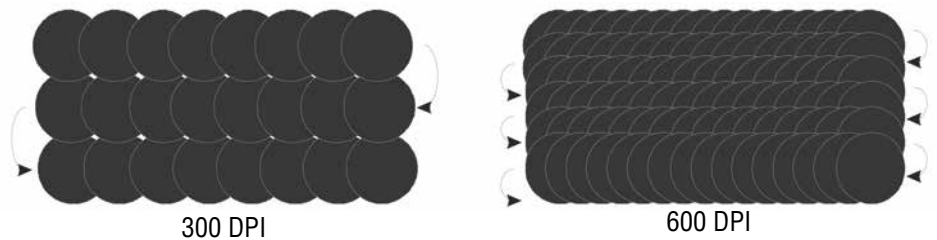

### Resolution Settings:

#### 75 – 200 DPI

These resolution values are typically used for non-production purposes where you want to experiment with image location, or if you want to quickly produce a rough draft. Low resolution settings are also useful when engraving products that you don't want to remove too much material while engraving, such as fabric.

#### 300 DPI

300 DPI is useful when engraving materials such as glass, marble, plastic and other items that don't benefit from the engraved dots being close together.

### 400 DPI

This resolution value is ideal for many applications. It combines very good image quality with fast engraving times. Many users like 400 DPI for all of their work.

### 600 DPI

When really fine detail or overall excellent results are required, most users choose 600 DPI.

### 1200 DPI

This resolution is used for projects that require the best engraving quality possible, or if engraving extremely small fonts. Although it's seldom used because, under normal circumstances, most people cannot visually discern the difference between 1200 and 600 DPI. There are some users that appreciate this high level of quality and are willing to take twice as long to produce an image at 1200 DPI as it would take them at 600 DPI.

## Helpful Hints

- There are four times as many dots engraved at 600 DPI as there are at 300 DPI. Twice as many horizontally and twice as many vertically.
- The gap between the dots is very small at 600 DPI. At 300 DPI the lesser overlap is responsible for the jagged edges that are visible when engraving at lower resolutions.
- It's important to remember that while resolution plays a part in producing good image quality, the artwork that is sent to be engraved is just as important. If the artwork that is sent to the laser is poor quality, trying to engrave it at 600 DPI will not improve the quality. It's always best to start with high resolution images. Poor artwork will probably always look poor at any resolution, while good artwork will look good at any resolution.
- Twice as many dots and twice as many lines at 600 DPI produces a much deeper burn into materials like wood than you would see engraving the same image at 300 DPI. This is important to understand because depth of burn is closely associated with engraving resolution – the higher the resolution, the greater the depth of burn for a given speed. The relationship between resolution, depth of engraving and Speed and Power setting is something that most people figure out with just a little experience. **“Appendix B: Material Settings” on page 193** helps to make this easy to understand by providing different Speed and Power settings and suggested engraving resolutions for each different material listed.

The next photo shows a clipart image engraved at 300 DPI (top) and at 600 DPI (bottom). This clipart image is full of different shades of gray and you can see that the dot spacing is spread out more on the 300 DPI than it is on the 600 DPI. Just changing the resolution to 600 DPI produces so much dot overlap that the fill patterns tend to blend together. It's a matter of personal preference as to which resolution looks better, but these photos show the dramatic difference resolution can make, especially when engraving with grayscale images.

# SECTION 8: QUICK START GUIDE

Resolution

## Landscape or Portrait



You can engrave using either landscape or portrait modes. Depending on the artwork, you can increase your efficiency and decrease the time it takes to engrave an image by changing the orientation of your file. Many users set up their artwork in portrait mode and then rotate the artwork 90 degrees if they are going to print from landscape mode.

300 DPI

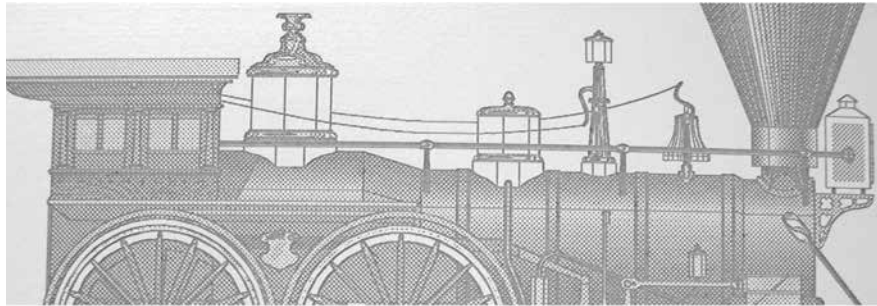

600 DPI

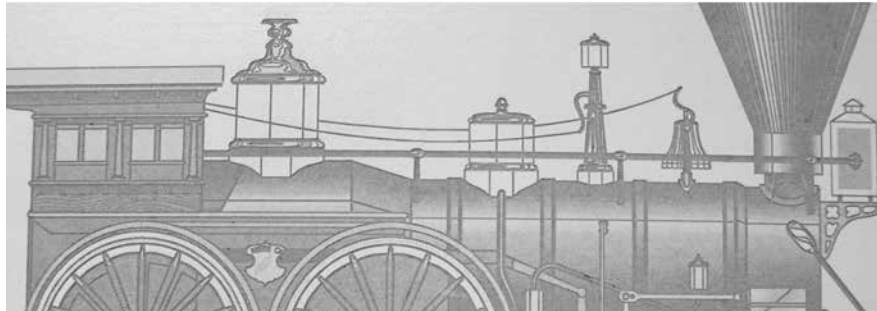

This project setup shows the same job in portrait mode (left) and landscape mode (right). The landscape mode will engrave quicker because there is less turnaround time as the laser makes longer passes across the engraving table. For example, at 100% speed and 100% power in portrait mode this graphic will take 56 minutes, 56 seconds, while in landscape mode it takes 38 minutes, 54 seconds, a 34% time savings.

Engraving Time: 56:56

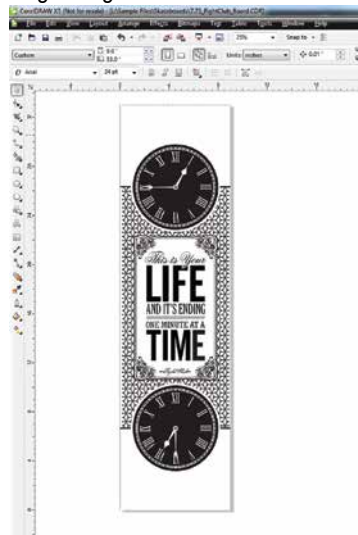

Engraving Time: 38:54

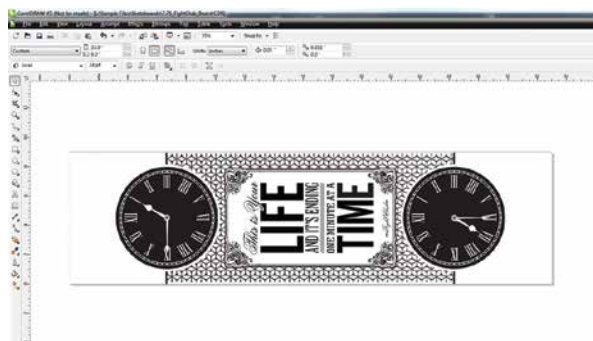

# SECTION 8: QUICK START GUIDE

The drawings below show a job that works in the opposite way - the horizontal mode will take longer than the portrait mode. You'll notice in the portrait mode there are a number of white space lines that the laser can skip through, saving engraving time. In the landscape mode there is not white space for the laser to recognize as it moves down the page, taking the engraving time from 10:12 to 17:14. Experiment with the artwork that you use. It will quickly become second nature which mode works best for different types of artwork.

Engraving Time: 10:12

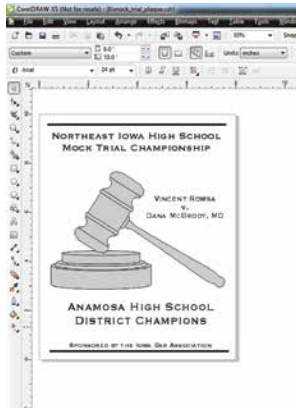

Engraving Time: 17:14

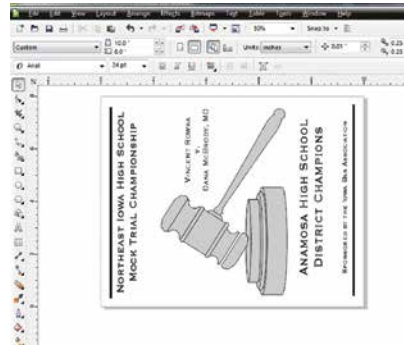

A third consideration for landscape or portrait art setup is material specific. Some materials, such as wood or plastics that have a grain or brushed look, will look better when engraved if the grain of the material runs parallel with the X-stroke of the carriage. While the orientation of material without a grain pattern is usually not important, it is important to keep this in mind with woods that have a stronger grain pattern.

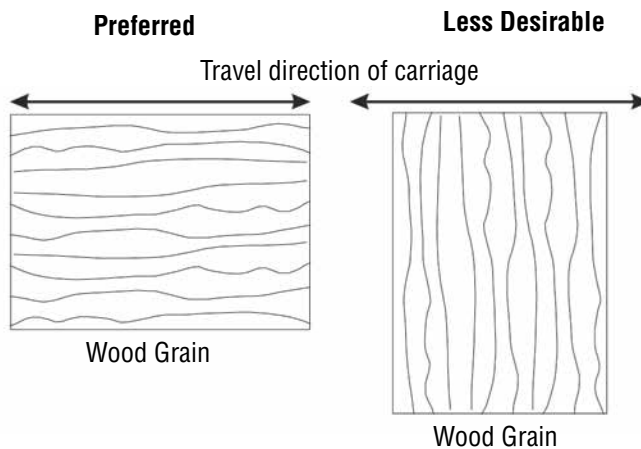



### Piece and Page Size

Many users like to create their artwork on a page size that matches the size of the piece that is to be lasered. Compensating for beveled edges or placing an image in an exact location is easy when there is a one-for-one relationship between the material and the page size of the artwork. If this method works for you, remember that you must also set the Piece Size dimensions in the Laser Dashboard to match the page size you have set in your graphics software.

On the other hand, many users do not want to change the Piece Size dimensions in the Dashboard every time they print something new. They prefer to use a page size that matches the table size and place their artwork into the upper left corner of the page. Both methods are effective and it is a matter of personal preference which method is used.

Place the material to be engraved on the engraving table in the upper left hand corner, pressing the material firmly against the metal rulers along the top and left edges.

Most material does not need to be held or clamped in place. Simply setting it on the table and letting gravity hold it in place is enough. If you are using a material that is likely to move during operation or is very thin, you can hold it in place using the Epilog Integrated Vacuum Table. Simply place it on the table flush against the upper left hand rulers, then cover any remaining holes in the metal table with scrap material or a jig. This will create a semi-suction and hold the piece of material in place. The material can also be held with a variety of materials such as masking tape, clay, magnets, etc. Creating jigs is also an excellent method of holding materials that are high volume, or high value. Engraving or cutting a jig to match an unusual shape is very easy to do with the laser from scrap wood, acrylic or even cardboard.



## SECTION 9: CLEANING & MAINTENANCE

Reduce Fire Risk with a Clean Laser

### Reduce Fire Risk with a Clean Laser



Cleaning the laser is an excellent way to prevent fire with the laser. A buildup of cutting and engraving residue and debris is dangerous and can create a fire hazard in its own right. Keep your laser system clean and free of debris. Regularly remove the Vector Cutting Table to clean any small pieces that have fallen through the grid.

**For more information on fire safety, see “Fire Warning” on page 5.**

### Cleaning the Optics

About once a week, or if you notice dust building up, you will need to clean the optics (mirrors and lenses) of your laser. If smoke, resin, or other contaminants are allowed to accumulate they will reduce the available laser power and may cause damage to the optics.

The two optical components most likely to require cleaning are the focus lens and the mirror directly above it. The lens and mirror are a single assembly, and can be removed from the machine for cleaning by unscrewing the three thumbscrews on the front lens cover.

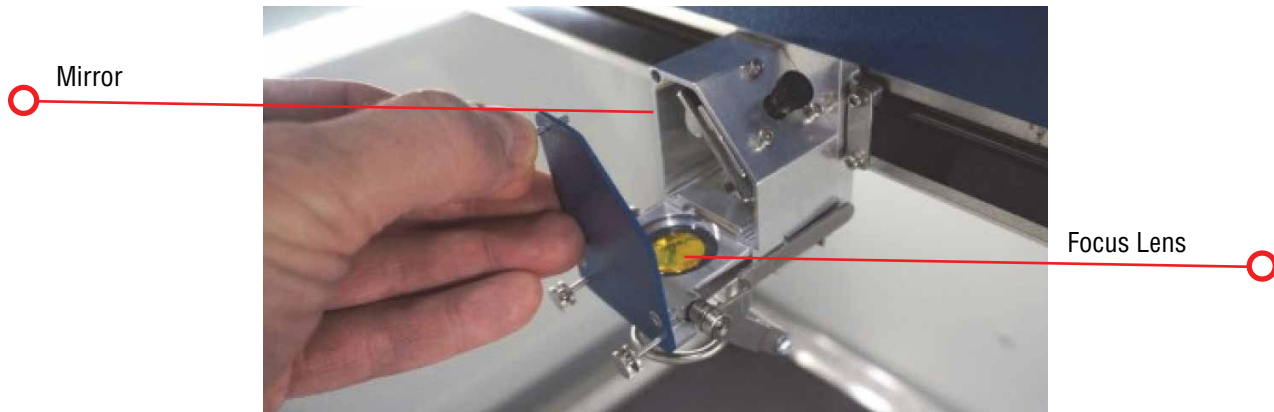

To clean the optics, use a high-quality cotton swab moistened with the optics cleaner supplied in the accessory kit. Please read the label on the bottle carefully.

If you run out of the cleaner supplied by Epilog, Reagent or laboratory grade Acetone can be substituted. Another option is a 10 to 1 water to white vinegar mixture. This is very good at removing finger prints and other minerals which can be left behind on the optics. Also, if “Golden Grain” or “Everclear” are available in your area these are also good substitutes for the optical cleaning solution.



Never use Alcohol or Hardware grade Acetone, they contain impurities which can damage the optics in your machine.

Wet the swab thoroughly with the solvent, and then blot it against a piece of cotton so that it is no longer soaking-wet. Then daub the optic gently, rotating the swab after each daub to expose clean cotton to the surface until the optic is free of visible contamination. At that point, prepare a fresh swab and clean the surface with a gentle zigzag motion across it. Avoid any hard “scrubbing” of the surface, especially while there are visible particles on it, and try not to use repetitive circular motions. When you are done, be careful to remove any cotton threads that may have snagged on the mountings.

## SECTION 9: CLEANING & MAINTENANCE

Allow the optics to dry before you operate your engraver.

When reinstalling the lens assembly, make sure that the Crash Bar is sitting on top of the locating pins on the side of the carriage.



In addition to the focus lens and the mirror directly above it, there is a mirror located on the left side of the X-beam. This mirror is very well protected and should not need regular cleaning. It can be accessed with a cotton swab if it does need cleaning.



The photos below shows how to clean the focus lens. Remove the lens carriage from the machine to clean both the top and bottom of this lens.

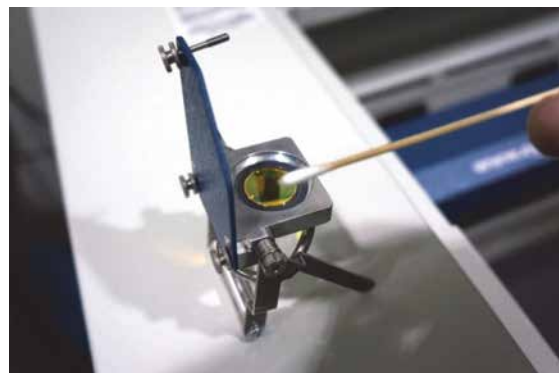

## SECTION 9: CLEANING & MAINTENANCE

Cleaning and Lubricating the Bearing Rails

### Cleaning and Lubricating the Bearing Rails

While the bearing rail on the Fusion M2 lasers are self lubricating, we still suggest a periodic lubrication to keep the laser running at top performance.

#### Clean the X-axis Bearing Rail

Use a soft cloth or cotton swab with some alcohol or similar mild solvent to clean each of the bearing tracks which the optics (mirror and lens) run along. A cotton swab is perfect for cleaning out the inside of the grooved tracks of the X-axis rail.

Use a soft cotton cloth or cotton swab to clean the entire length of the X-axis rail.

This photo shows a cotton swab cleaning out the top groove of the X-axis rail. There is another groove on the bottom side of the rail. You will need to move the X-axis belt out of the way to access the rail. There is enough flex in the belt to move it out of the way, but do not pull on it so hard that it becomes stretched or stressed.



#### Lubricate the X-axis Bearing Rail

After cleaning the rail, place about an inch long bead of Epilog supplied grease into the top and bottom grooves of the X-axis rail. The following photo shows where to grease the bottom groove of the rail.

After applying the grease to both grooves, run the X-carriage over the grease to work it into the bearing block and rail.

Turn the machine off to easily move the X-carriage back and forth over the grease.



## SECTION 9: CLEANING & MAINTENANCE

Cleaning the Exhaust Plenum

### Clean the Right Side Y-Axis Rail

Clean the length of the right side Y-axis rail using a soft cotton cloth. Lubrication is not required.

○ Clean the right side Y-axis rail with a soft cloth.

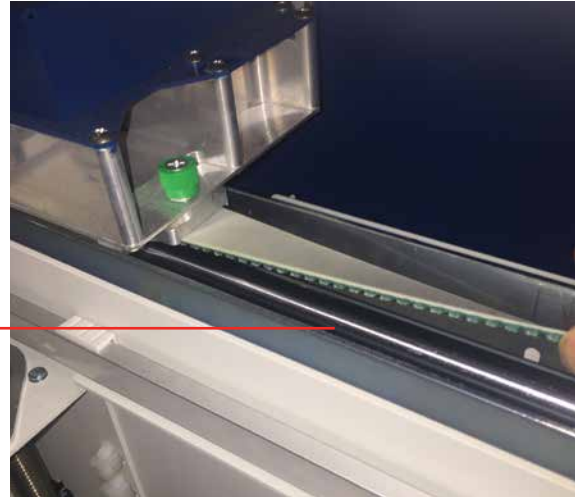

### Clean the Left Side Y-Axis Rail

Clean the length of the left side Y-axis rail using a soft cotton cloth. Lubrication is not required.

After cleaning the rails and bearings, clean off the table and the rest of the inside of the machine. Spending just a few minutes a week will pay off in the long run with better quality and performance.

○ The left side Y-axis rail (the silver cylinder) should also be wiped with a soft cloth.



## Cleaning the Exhaust Plenum

Make sure the exhaust blower you are using receives proper maintenance. Periodically clean the exhaust blower and duct system to remove built-up debris. If you detect odor while engraving, or if the smoke in the cabinet is visible in the area of the lens carriage, inspect the exhaust system. Check for loose or broken pipe/hose connections, or obstructions. The following photos show where to clean the duct work of your machine. You should also occasionally check your exhaust blower and the connected duct work.

## SECTION 9: CLEANING & MAINTENANCE

Cleaning the Exhaust Plenum

### Cleaning the Vents

Clean the vents from the inside of the machine. It is best to use a flexible or wire brush that can access the inside of the vent.

Clean the vents with a flexible or wire brush.



### Cleaning the Down Draft Ports

In addition to the top vents, also clean the down draft ports. These are the air ports that the exhaust system pulls from when using your Vector Cutting Table.

The down-draft ports are located in the black circles at the back of the machine.

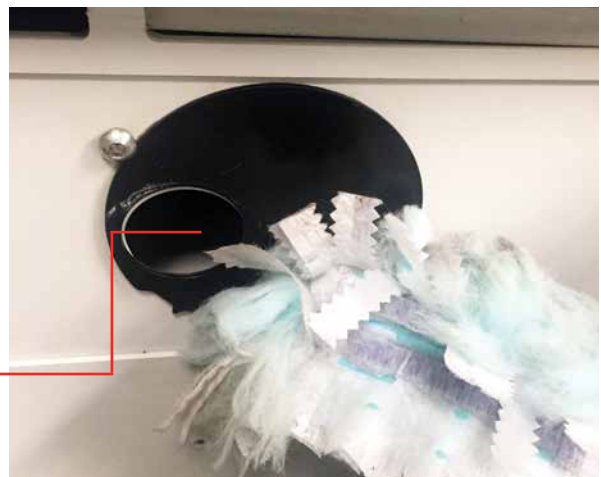

## SECTION 9: CLEANING & MAINTENANCE

Cleaning the Exhaust Plenum

### Cleaning the Exhaust Plenum

In addition to cleaning the inside of the machine you should occasionally clean the exhaust plenum. The exhaust plenum can be completely removed from the Fusion. Remove the six screws that hold the exhaust plenum in place.

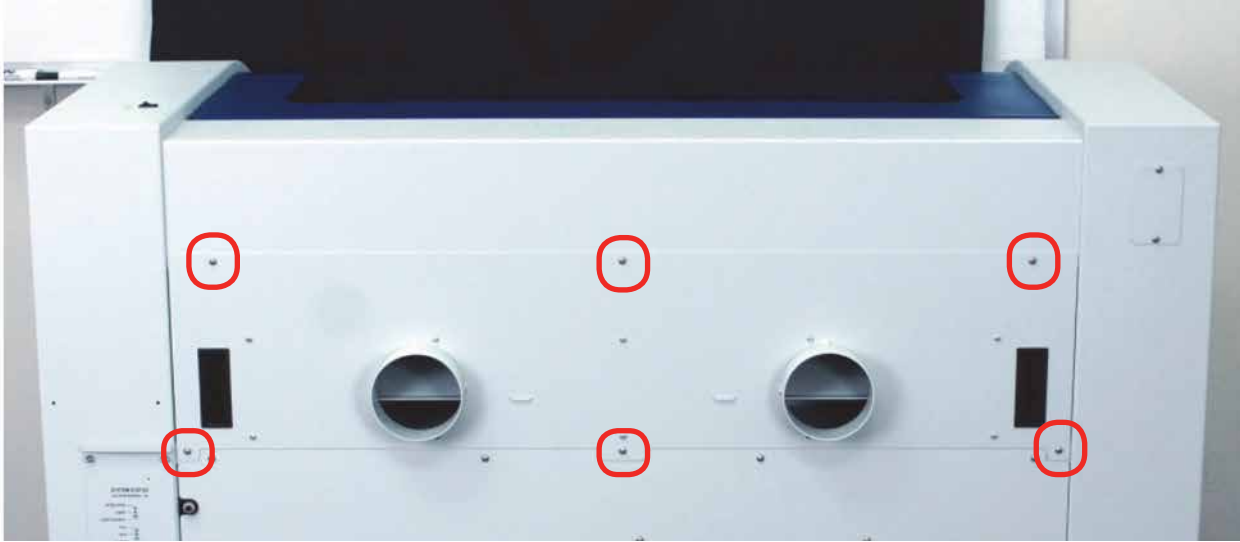

The photos below the plenum partially removed and the back of the machine with the plenum fully removed.





### Laser Tube

The laser tube used in your system does have a maximum service life, and there is very little maintenance that is required. At some point in the life of the laser you will need to replace it for gas recharge, electrical repair or mechanical repair. Replacing laser tubes is common practice and Epilog has made the process of changing tubes extremely easy for users to perform with a minimum amount of effort. The laser tubes can be refurbished and are available on an exchange basis by contacting Epilog technical support.

Ensure that all of the laser cooling fans are properly working at all times. The fans keep the laser tube cool and prevent it from overheating. An overheated laser tube will produce erratic output and may fail completely.

If the laser system is in a dirty or dusty environment, make sure that the cooling fins on the laser tube are kept free of dust buildup. Use compressed air to blow the dust and debris off of the laser tube fins. Be sure that the system is unplugged before performing any maintenance on the machine!

### Laser Tube Air Filter

To help protect your laser tube from dust, dirt and debris, we have included a filter on the back of the Fusion Laser. Every three months, check the filter to see if it needs replacement. The filter is a standard 12" x 30" x 1" (304.8 x 762 x 25.4 mm) furnace filter and can be found at any home store. Changing this filter is much more likely in a dustier shop environment.



# SECTION 10: SYSTEM FEATURES

## Air Assist

The Air Assist feature on the Fusion Laser is used to keep combustible gases away from the cutting surface and to reduce flare-ups of more flammable materials as you cut through it, such as wood and acrylic.

The Air Assist directs a constant stream of compressed air across the material surface at the point of burn removing the heat and combustible gases from the work surface. The constant air stream helps reduce charring and scorching associated with materials, such as wood, rubber, and acrylic.

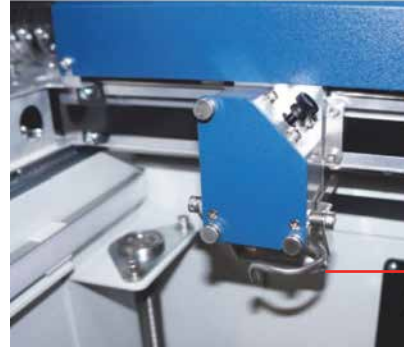

Air Assist Tube



The Fusion M2 systems have been pre-plumbed for Air Assist so that all you need to do is to attach a small compressor pump to the back of the machine. The pump can either be purchased through your Epilog representative or you can connect your existing compressed air supply to the .25 inch (6 mm) receptacle at the back of the machine (30 PSI max).

**Air assist should always be activated during vector cutting operations to reduce the risk of fire!** For more information, see “Fire Warning” on page 1.

## Auto Focus vs. Manual Focus

In order to engrave or cut a crisp, clean image, your material must be the correct distance from the bottom of the focus lens. Setting the distance from the bottom of the focus lens to the top of your material is the process of focusing, and is accomplished by placing your material on the table and moving the table up or down. There are two different methods of focusing: Manual or Auto Focus.

### Manual Focus

The photo below shows the “V” shaped manual focus gauge that is used to determine the correct distance from the focus lens to the top of your material. This gauge is included in your Accessories Kit that comes with your system. **If you have a dual source Fusion M2 system, there will be two separate focus gauges for the CO2 and fiber laser sources.**

Place the manual focus gauge on the carriage and place the object to be cut or engraved in the upper left corner of the machine. Use the arrow keys on the control panel to highlight the light next to the word **Focus**. You can now move the **Joystick** up or down to move the table appropriately until your material just touches the bottom of the gauge. The speed at which the table rises or lowers can



## SECTION 10: SYSTEM FEATURES

Auto Focus vs. Manual Focus

be controlled by applying varying pressure upwards or downwards on the **Joystick**. Once the focus position has been established, remove the gauge. Press the **Reset** key.

If your material has a taper or curve, pick an intermediate point between the highest and lowest points being engraved and focus on that point. In general, the area of the material being engraved needs to be relatively flat. If the area being engraved differs in height by more than about an .125" (3 mm), the image will begin to look "fuzzy" or out of focus.

**Manually Focus Anywhere on the Table:** If you wish to focus at a point on the table other than in the upper left corner, you can do so by activating the Jog feature of the machine. Press the **Arrow** keys on the Control Panel until the light next to **Jog** is illuminated. This now activates the **Joystick** to allow you to move the lens carriage of the laser to the desired position on the table. Again, varying the pressure applied to the Joystick will vary the speed at which the lens carriage moves to the desired position on the table. Once the lens carriage is located over the desired portion of the table, use the procedure above for raising and lowering the table until the focus gauge touches the top of the material. After you have focused, press the **Reset** key to send the carriage back to its Park position.

### Dual Source Manual Focus Gauges

If you purchased a system with the Dual Source option, you will receive two separate focus gauges with your laser system, a 3" focus gauge for the CO2 (blue) and 3" gauge for the fiber source (silver). The optimal focal point for each of the laser sources is a bit different, so two separate gauges are required based on the material you are working with in each job. When you are using Auto Focus, the machine will automatically compensate based on which source you have selected. For more information on focusing the Dual Source, see "**Focusing a Dual Source Job**" on page 147.



## Auto Focus



Activating the Auto Focus can be done on your computer by checking the **Auto Focus box** in the dashboard. If there is not a check in this box, Auto Focus will be disabled and the table will not move up or down when the job starts.

When a job is started, and Auto Focus has been enabled, the table will automatically raise or lower to the appropriate height before the lens carriage moves to the first point of engraving/cutting.

You must also indicate if you are using a Vector Cutting Table. When the Vector Cutting Table is installed and you want to use Auto Focus, click the box next to **Vector Grid**. This tells the laser system that the Vector Cutting Table is installed and it will automatically calculate the appropriate focal distance based off this information.

**Please note:** The material thickness is still required when using the Vector Cutting Table. If a thickness is not specified the system will Auto Focus to the top of the grid, not to the top of your material.

## SECTION 10: SYSTEM FEATURES

### Crash Bar

To enter the material thickness of the object you will be engraving/marking/cutting use a pair of calipers for an accurate measurement and enter this value in the “Thickness” box in the driver.

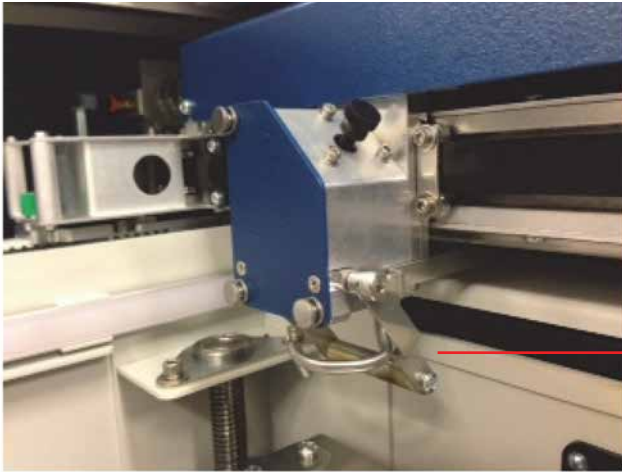

Crash Bar



**WARNING:** If you are using Auto Focus and you know there is not enough clearance between the lens carriage and your material, you will need to lower the table before you insert your material and start the job. To lower the table, use the Arrow keys on the Control Panel to illuminate the light next to the word “Focus”. Then use the Joystick to lower the table enough to accommodate your part.



Please be careful when Auto Focusing on irregularly shaped items. The crash bar and Air Assist tube must clear all edges of the work piece in this situation also. The Crash Bar is a safety feature that prevents the table from moving up too far into the lens carriage and X-beam.

## Crash Bar

The Crash Bar is mounted to the lens assembly and prevents the table from “crashing” into the X-beam when the table is moving to its focus position. If the table moves up into the crash bar the system will come to a complete stop and the table will automatically lower two inches.

If the crash bar is activated, press the **Reset** key on the front Control Panel to restore functionality.

The crash bar is removed as part of the lens assembly. When reinstalling the lens assembly, please make sure that the Crash Bar is sitting on top of the locating pins on the side of the carriage.



Crash Bar and  
Locating Pins

## Image Dithering

Dithering defines how the dot patterns will be engraved in raster images that contain grayscale graphics, blends, or color images. The Dashboard offers six different dithering patterns to enhance your engraving projects. The default mode is Standard. This mode can be used for all images including photographs. Dithering is used only for raster engraving and has no effect on vector cut lines.



Laser engraved photographs on wood usually require a third party software package to produce a good image that is suitable for the laser. Epilog recommends **PhotoLaser Plus** for this application. Users find it an invaluable piece of software that is easy to use and will produce much better looking images when working with wood. Please contact your Epilog representative to learn more about this software package.

### What is Dithering?

The best way to show dithering is to look at the exact same photo engraved in Standard mode and Stucki mode. Both photos were engraved at 300 DPI. With the two different dithering patterns you achieve a very different result, with a more structured pattern for the Standard mode, while the Stucki mode results in a more random pattern that looks more natural and pleasing to the eye.



300 DPI Standard Mode



300 DPI Stucki Mode

Dithering is a great way to enhance your engraved products, but it is very material dependent. A dithering pattern that looks good on marble, might look very different when engraved on plastic. Give yourself some time to experiment with the different dithering patterns. It's easy to do and once you have a feel for it, you will be able to use it with confidence

The drop-down list of dithering patterns is easier to think about if you separate the six options into two categories that we will refer to as Clipart and Photograph:

### Clipart Modes

- **Standard:** This mode is the default mode and will be used for most engraving jobs that include text and clipart at 600 DPI.

- **Brighten:** This lightens the clipart, and some users also find this mode good for engraving photographs onto wood or marble at 600 DPI.
- **Low Res:** Adds an artistic half-tone type look to the engraving which sometimes helps when engraving low-resolution photos.

### Photograph Modes:

- **Floyd-Steinberg:** Produces an almost wave-like pattern to an image. This works well for some photos containing a great deal of detail. Photos with more monotone swatches of color may not be as pleasing as Jarvis or Stucki modes.
- **Jarvis:** Many users find this mode good for engraving photographs at 300 DPI. This mode produces a very nice looking pattern on almost all photos.
- **Stucki:** This mode produces results that are only marginally different than the Jarvis dithering pattern. It is also very good for engraving photographs at 300 DPI. The differences between Jarvis and Stucki are very subtle.

Experiment with the different dithering patterns to determine which effect is most pleasing. It is not mandatory that you use the clipart modes with only clipart images or photograph modes with all photographs. Many users prefer one of the photograph modes for many clipart images, and one of the clipart modes for photographs. The choice is entirely up to you and will take some experimentation.

We have included some sample photographs on the Epilog driver disc for you to experiment with. Use these photographs to engrave on different materials using the different dithering options so you can get a feel for how each dithering pattern affects the image and the material.

## Color Mapping

The Color Mapping feature is an advanced feature that allows you to set different engraving and cutting settings to different colors within your artwork, and can be used in both raster and vector modes. The functions that can be controlled by color are: Speed, Power, Frequency, Focus, Raster On/Off, Vector On/Off and Air Assist On/Off. While Color Mapping is a very powerful tool, most users use it for four main reasons:

1. Using different colors to engrave at different speeds and powers within one document.
2. Using color to define different levels of focus. Many objects need to be marked at different locations that are at different relative heights. Using color mapping to change the focus in a single job setup is a convenient way to make marking complex parts simple.
3. Using different colors to allow users the ability to sequence the order that objects will be marked.
4. Using colors to define the registration marks in the Epilog Job Manager when using the eView™ Camera System.

For more information, see “**eView Camera Module**” on page 135.

- When using the Dual Source option for the Fusion M2 to define CO2 and Fiber portions of the engraving job. For more information, see “**Setting Up a Dual Source Job**” on page 146.



## Using Color Mapping

### 1 Enable Color Mapping

When this check box is selected, the laser will use the settings assigned to each color. For any colors that are in your artwork, but not in the color mapping settings, the General settings will be used.

### 2 Adjust Settings

Use the slider bars to set any RGB color and create the laser parameters. Adjusting the settings does not actually change the values. Select the **Right Arrow** key to finalize the settings.

### 3 Color Map Summary

The Color Map Summary area is located on the right side of the window and offers a visual display of all of the color mapped settings.

- To use Color Mapping, start by enabling the Color Mapping section by **clicking the check box** in the upper, left corner of the screen.
- Select a color** in the Summary area. We selected the color Red.



## SECTION 10: SYSTEM FEATURES

3. **Adjust the laser settings** in the Settings area.
4. Once the laser values have been adjusted, press the **Modify key** in the Settings area. The available keys are:



Add a Color



Modify a Color



Delete a Color



Move Color Up in List



Move Color Down in List

5. You'll see that in the Summary area, the new settings assigned to the color red are now displayed.

### Color Mapping Functions

**Speed:** Applies a speed setting for all objects of the same color.

**Power:** Applies a power setting for all objects of the same color.

**Freq:** Applies a frequency setting for all objects of the same color.

**Focus:** Sets the focus distance for a color. This setting uses increments of 10 and each increment of ten will change the table height by 0.001" (0.0254 mm). Change the slider in increments of ten by clicking directly on the plus or minus icons.

- Any time the focus setting is a **positive number** it means the table is being **moved away** from the focus lens. In other words, a positive number indicates that the gap between the table and the focus lens is getting greater (increasing).
- Any time the focus setting is a **negative number** it means the table is being **moved closer** to the focus lens. In other words, a negative number indicates that the gap between the table and the focus lens is getting smaller (decreasing).
- The Focus slider has a range of -500 to +3000. This range allows the user to move the table closer to the lens by as much as 0.50" (a setting of -500), or move the table away from the lens by as much as 3" (a setting of 3000).



**Raster:** With this box checked, all raster objects set to that color will be processed at the color mapped settings; however, this function will still not allow a vector line set to a Vector stroke width to engrave.

**Vector:** With this box checked, all vector objects set to that color will be processed at the color mapped settings; however, this function will still not allow a raster object to be processed as a vector.

**Air Assist:** With this box checked, all objects will be processed with Air Assist turned on.

### Using Color Mapping for Multiple Speed and Power Settings

A fairly typical use for vector color mapping is in the architectural industry and making models. Users want to lightly mark one part of the work piece and cut out another part of the same piece.

## SECTION 10: SYSTEM FEATURES

Usually, when using Color Mapping in Vector mode, users want to produce a different look on two separate areas of a single piece of material in a single job setup. To achieve a different look for each mark the marking processes require different speeds and powers so this is a perfect job for Color Mapping.



**Note:** While you could set the vector line you want to just mark to an engraving width, it takes much longer to engrave a box than to use vector settings to quickly follow the line and mark it.

The graphic shows a simple architectural drawing. The drawing is set up so that when we use Color Mapping, we will assign one speed and power setting to first lightly engrave the window frames and a different speed and power setting to then cut out the individual window panes.

The outside frame of the house will not be Color Mapped since it is not a color that has been assigned in the Color Mapping Summary area. **That line and any other lines that are not a color mapped color will be processed at the speed and power settings that are set in the General Tab of the Dashboard.**

We have assigned the window frame vector line to the RGB green color, and the window panes to RGB red. You **MUST** use an RGB color scheme in your artwork with the Color Mapping feature. **CMYK values will not translate.**

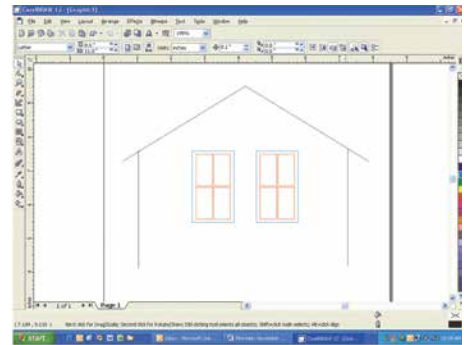

It's best to use one of the six basic colors (red, green, blue, cyan, yellow, magenta) when color mapping, because the values in Color Mapping **must match exactly** the colors that are used in your graphics package. The RGB color scheme uses numbers to define all colors and the six basic colors have the following numerical definitions:

Color	Red Color Value	Green Color Value	Blue Color Value
Red	255	0	0
Green	0	255	0
Blue	0	0	255
Cyan	0	255	255
Yellow	255	255	0
Magenta	255	0	255



**A CMYK palette will not work!** The six basic colors are easiest to use because they only use combinations of 255 and 0 (255 is the highest number value and 0 is the lowest in the RGB color scheme). Because all graphics packages use the six basic colors, this is easy to do. The Laser Dashboard loads the six primary colors as presets for your convenience. Any color can be added or deleted to meet your needs.

## SECTION 10: SYSTEM FEATURES

1. Once your vector outlines are set up in your artwork, Select **File/Print** and go to the **Color Mapping tab** in the Laser Dashboard.
2. Make sure **Color Mapping is checked** so we can set up our color mapping settings.

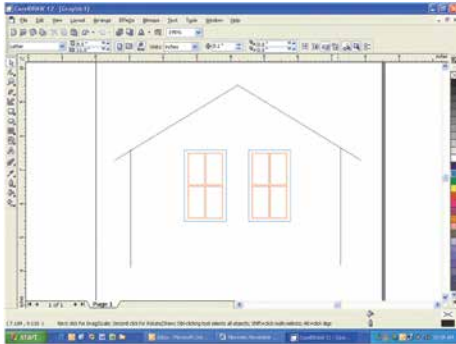

3. In our example we want to mark the green window frames first, so green must be the first color at the top of the list. Normally the color green is the second color down in the list. In order to move it we just select it and press the **Up key** to move it up one position. We now have green at the top and red is the second color down. This is the order that the colors will be processed.
4. With the green color selected in the summary, we set a higher speed and lower power (50% speed, 10% power) to just mark the top of the piece. When you have your settings as you'd like them, click the **Modify** key.
5. Repeat by selecting the Red color in the summary area, then adjusting the speed to 20% and power to 100%, then clicking the **Modify** key.



### Using Color Mapping to Adjust Focus

To engrave at multiple focal points on an object with several levels, the Color Mapping feature is very useful. In the following example we want to mark on both Surface 1 and Surface 2 on the following part where Surface 1 is 0.250" (3 mm) higher than Surface 2.

We will set up our artwork so that we engrave the Model Number on Surface 1 and the Serial Number on Surface 2. For this job, the only change we will make is to the Focus distance. Everything else will be the same. A glance at the Summary section shows the Focus for the color red at 0 and the Focus for blue at -250. When you run the job, the red will engrave on Surface 1 first and then the table will move up and engrave the blue text.



# SECTION 10: SYSTEM FEATURES

We've setup the graphic with the model number in red and the serial number in blue. In the Color Mapping tab you can see that we've set the blue to engrave at a focus point of -250. Since every increase of 10 moves the table further from the laser by 0.001" (0.0254 mm), we are telling the table to raise .025" (0.635 mm).



## Using Color Mapping to Adjust Object Order

Another popular use for color mapping is to adjust the order a series of objects engraved or cut. In the example below, there are three columns of names we are engraving. If we engrave the left file in the image below, the laser carriage will have to travel all the way across the table, covering a lot of empty space, to engrave the image.



If we adjust the colors in each bar, we can setup the color mapping to engrave first the red bar, then the green bars in the center, and finally engrave the blue bar on the right side of the page. The engraving time drops from 39:09 to just 22:14 by using Color Mapping in the file setup.

Engraving Time: 39:09

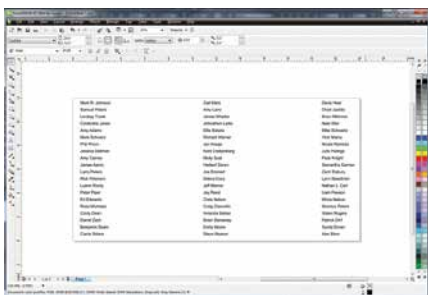

Engraving Time: 22:14

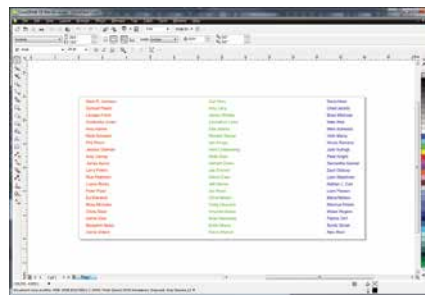

## Additional Color Mapping Notes

- When color mapping is used, it always starts from the top color in the Map List and then descends through the remaining colors.
- There's one important distinction to recognize about how colors are raster engraved in standard engraving mode vs. Color Mapping mode. In standard engraving mode different colors are interpreted as different shades of gray that will produce different fill patterns when engraved. In Raster Color Mapping mode all of the different colors are engraved as if they have a black fill. There is no way for a color to produce both a fill pattern and be color mapped at the same time.

### Non-Mapped Colors

Non-mapped colors will be processed last and will be processed using the Speed and Power settings from the General tab. An example would be artwork that has black lines as well as the red and green we are mapping. The black lines will be processed last at the speeds and powers that are set in the General tab.

### Color Mapping in Combined Mode

Color Mapping in combined mode requires a little more planning than Raster only or Vector only modes.

1. Any object that is color mapped will be raster engraved first in the order the colors appear in the Summary section of the tab. Any other raster objects that are not color mapped will then be raster engraved using the raster settings found in the General Tab.
2. After all of the raster objects have all been engraved, the vector objects will be vectored in the order they appear in the Summary section of the tab. Any other vector objects that are not color mapped will then be vectored using the vector settings found in the General Tab.



For most jobs, Color Mapping is a powerful and easy tool to use and understand. Please keep in mind that because you can control seven different variables and 17 different colors doesn't mean that you should. With so many different settings available in a single setup it has the potential to get overly complicated. Sometimes it's easier to scale back on how many colors a job should use.

### Reset Home Position

To reset your Home Position, on the Control Panel select the Jog Function. Double center click the Joystick to access the sub-menu, then tilt the Joystick to the right to reset the Home Position.

### Red Dot Pointer

The Red Dot Pointer is a visible laser beam that runs in the same line as the invisible CO2 laser beam. The Red Dot Pointer serves several purposes on the laser, and will become one of your favorite features of the Fusion Laser.

### Set a New Home Position

Use the Red Dot Pointer to set a new Home Position by moving the laser head the Control Panel's Jog function. Move the laser to the new Home Position and set a new Home Position by center clicking the Joystick.

### Position Your Artwork



This is a popular use for the Red Dot Pointer and is one of the easiest ways to make sure each project you run is going to engrave or cut in the correct position. **Learn this easy task and use it!**

1. For a visual representation of the engraving area on a project, create a box around your engraving area with a stroke width of .001" (.025 mm).
2. On the General Tab set a vector setting of 0% power. **With the door of the Fusion raised so the laser won't fire,** run the job. The Red Dot Pointer will outline the area where the job will run, so you can make sure that you have the correct positioning before running any job. (Setting the power to 0% will also protect you in case you forget to leave the door open).
3. Now you can reposition the artwork, or the piece you are engraving, so you have a perfectly located engraving project.

### Movable Home Position

When engraving irregularly-shaped objects, Epilog's movable Home Position feature will quickly become one of your favorites. You can quickly set a new Home Position using the Joystick at the control panel and set a new Home Position in seconds.

Setting a new Home Position has never been quicker or easier. Let's say you're engraving on a custom acrylic award that won't quite fit in the upper left corner of the work area. By moving the award out into the center of the table and setting a new Home Position at the upper left corner of the award, you can rest assured that your engraving will be placed accurately on your engraving piece every time in a few easy steps.

1. Start by turning on the **Red Dot Pointer** at the Control Panel, then move to **Jog** in the Function area of the Control Panel.
2. Use the **Joystick** to move the laser carriage to your new Home Position.
3. **Center click** the Joystick to set your new Home Position.
4. The new Home Position that you set is the new 0,0 point for the top, left corner of your engraving area.
5. When you are done and want to reset your Home Position, go to the **Jog** function, then **double center click** the Joystick to access the sub-menu. **Tilt the Joystick to the right** to reset the Home Position.

## Center Engraving

The Center Engraving feature allows you to define the center of your artwork as the primary reference point (Home Position) of your engraving or cutting. The Center Engraving feature has been designed to be used in conjunction with the Jog feature on the Fusion Control Panel. Center engraving differs from standard printing where the upper left corner of the page and the upper left corner of the laser table define your primary reference point.

- You can identify a Center Engraving job at the laser when you see an asterisk at the end of the job name.
- If you get a Position Error reading on the display screen, your artwork is going to go outside of your available work space.
- There are four choices for Center Engraving: Center-Center, Left-Center, Top-Center and Page-Center.

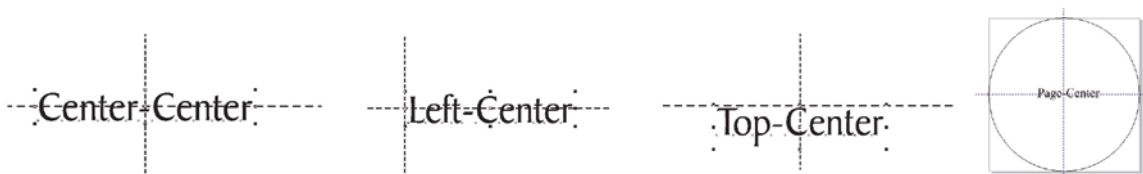

### Center-Center

When using Center-Center, the overall size of your work piece and the upper-left corner reference point are not important. With Center-Center engraving the important starting points are the size of your artwork and the available space for it on your work piece. With Center-Center you're interested in positioning the center of your artwork to a specific point on your work piece, no matter where your work piece is on the laser table. When using Center-Center you can place your artwork on almost any size of page and almost anywhere on that page.

The detailed examples on the next few pages show how easy it is to think differently about Center-Center jobs.

**Example:** A customer brings you a small electronic item to engrave, such as an iPhone. To quickly engrave the item without extensive measuring, follow these quick steps:

1. Measure the area you have available for engraving. For the iPhone we have about 2" x 1.5" (51 x 38 mm) of engraving area.
2. In your graphic software, create a new page. Page size is not important, so set the page size to larger than the area you want to engrave. We have created a page 4" x 4" (101 x 101 mm). Place your image anywhere on the page and size it to fit in the 2" x 1.5" (51 x 38 mm) engraving area.



- To insure the graphic is correctly positioned, draw a vector box around your artwork with a vector cutting stroke width (.001" or .025 mm). **Print** the box to the laser.
- Click the check box next to **Center Engraving** in the General Tab of the driver.
- In the drop-down box, select **Center-Center**.
- Set the page size to match the page size in the Laser Dashboard (4" x 4" or 101 x 101 mm).
- Select **Vector** as your job type.
- Set a **Vector Power Setting of 0%** and print the job to the laser.
- Run the job with the laser door open** (so the laser won't fire). If the engraving area is lined up, delete the outline you created and print the engraving job to the laser.
- After the job is complete, you can reset the Home Position by going to **Jog** mode, then **double center clicking** to access the sub-menu. **Tilt the Joystick to the right** to Restore Home.

While Center-Center is the most common use for the Center Engraving features you can also use **Center-Left** and set a Home Position that is the left portion of your engraving area. **Center-Top** is at the middle, top area of the area you want to engrave. Depending on the object you are engraving, this may be easier to find than the center point of the engraving area.

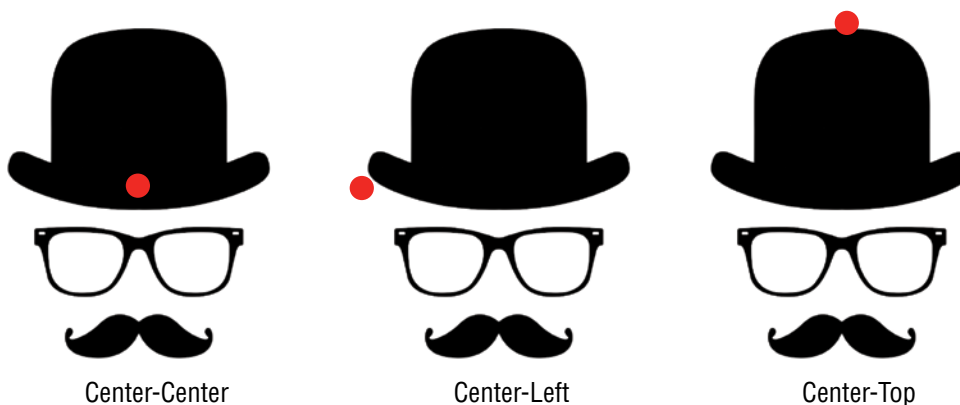

The red circle signifies the Home Position for each Center Engraving choice.

## Page-Center

When you are engraving an unbalanced image (not equal left to right or top to bottom), you will want to use the Page-Center feature. For this example, if we engrave the image with Center-Center settings, the graphic will not look centered on the object because the actual center point is to the right of the point we want to center in the logo. To get around this, we'll use Page-Center.

- Set the page size** to the area you want to engrave. Unlike when we used Center-Center, **page size is important when using Page-Center**.
- Center** your graphic on the page with the center point you want to use (the image on the right).





Actual center point.



Center point we want to use.

3. In the Laser Dashboard, check the box next to **Center Engraving** in the General Tab, then select **Page-Center** from the drop-down box. **Set the piece size** to the size of the page you created.
4. Set the Home Position as the center of the object you are engraving using the steps in the previous example.
5. Run the job and you'll have a properly centered image.

## Emergency Stop Button

On the front of the laser you will see a large, red Emergency Stop key. If there is an emergency, such as a fire, immediately press the Emergency Stop key. The laser carriage will immediately stop and the system will shut down.

To reset the system, you must **turn off the system** using the regular power switch, then twist the **Emergency Stop key** clockwise to release the system, then **turn on the laser**.



If your laser ever stops running and you can't turn it on, check to see if the Emergency Stop key has been pressed by accident.

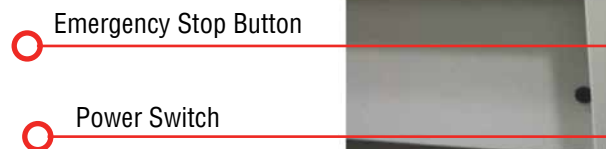

### Front Access Door

The front access door is usually used for easy loading and unloading of palletized materials. The door is interlocked and the laser will not fire if the door is open.

The front access door is supported by struts. The struts can be disconnected if you wish to open the door more than the standard 90 degree opening. Remove the left and right thumb screws to allow the door to open the full 180 degrees.



### Task Plate/Vacuum Hold-Down Table

#### Task Plate

On the Fusion, the task plate is used as the standard engraving table for jobs that do not include vector cutting. The task plate is stainless steel and allows you to use magnets to hold oddly shaped items in place.

#### Vacuum Hold-Down Table

The holes in the task plate provide vacuum hold-down capability that keeps thin materials flat while engraving. The exhaust system is designed so that it evacuates from both the top and the bottom of the task plate when the task plate is at its highest position. The exhaust pulls air through the holes and forms enough of a vacuum that it will flatten slightly warped paper, wood, aluminum sheet stock and other materials. As long as the exhaust is operating and the task plate is no more than an inch (25.4 mm) below its highest point, the vacuum table will work.



If you have a piece of sheet stock that does not flatten out because it is not covering enough of the vacuum holes, you can use any material (including paper) to cover some of the exposed holes. Simply blocking most of the vacuum holes will be enough to flatten most sheet stock as long as it is not too severely warped, bent or too rigid. Magnets can be used to hold oddly shaped items in place if needed.

## Exhaust Plenum

The Fusion incorporates an exhaust plenum and an integrated Vacuum hold-down table. Both the exhaust plenum and the hold-down table use the airflow from the exhaust fan for two distinct functions.

1. **Exhaust Plenum:** The exhaust fan moves air from the front towards the rear of your machine and out the exhaust plenum. This air removes combustible gases and smoke through the exhaust plenum.
2. **Vacuum Hold-Down Table:** The Vacuum Table and the Vector Cutting Table each mate to the manifold with spring-loaded ports that are located at the back of the table and grid. Air from the exhaust fan pulls air through the table and grid to provide suction that pulls slightly warped material flat as well as moving smoke and fumes towards the exhaust plenum from under your material when you are using the Vector Cutting Table.

The large black manifold at each exhaust port can be rotated to different positions depending on the table you are using. Simply loosen each screw on the left edge of the manifold to the desired option. The photo above shows the four black manifolds. To rotate the manifold, loosen the Phillips-head screw holding it in place. The photo to the right shows the manifold halfway between the 2" lens and the Downdraft Table options.

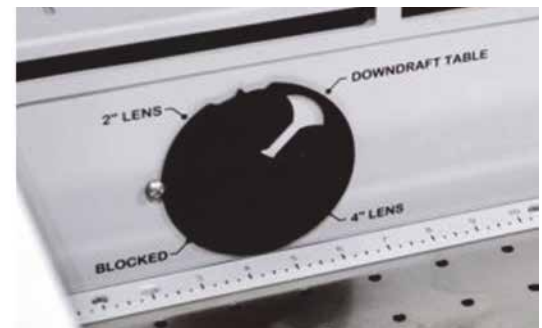

### Fusion M2 32 three manifold options:

1. **Blocked:** Rotate the manifold to this position if you want to block all airflow through the table. This option only blocks air from moving through the table. It does not block air from moving through the exhaust plenum.
2. **Downdraft Table:** Rotate the manifold to this position when you are not using a Vector Cutting Table.
3. **Vector Grid:** Rotate the manifold to this position when you are using the standard lens with the Vector Cutting Table installed.



### Fusion M2 40 four manifold options:

1. **2" Lens (with vector grid):** Rotate the manifold to this position when using the standard 2" lens with Vector Grid installed.
2. **Downdraft Table (Task Plate):** Rotate the manifold to this position when you are not using the Vector Grid.
3. **4" Lens (with vector grid):** Rotate the manifold to this position when you are using the optional 4" lens with Vector Grid installed.
4. **Blocked:** Rotate the manifold to this position if you want to block all airflow through the table. This option only blocks air from moving through the table. It does not block air from moving through the exhaust plenum.

## SECTION 10: SYSTEM FEATURES

In addition to the three manifold options, the exhaust plenum is divided into four (Fusion M2 32) or five (Fusion M2 40) sections. Each section uses two thumbscrews to vary the amount of air flowing over your material towards the back of the machine and through the exhaust plenum.

When working with smaller items that do not fill up the entire laser bed, it may be advantageous to block the plenum sections that are not directly in the path of the area being engraved.



Two thumb screws to adjust air flow for each section.

## Safety Interlock / Laser Status Indicators

The Fusion M2 status indicators are located on top of the machine, to the right of the top cabinet door. Their markings, colors and functions are as follows:

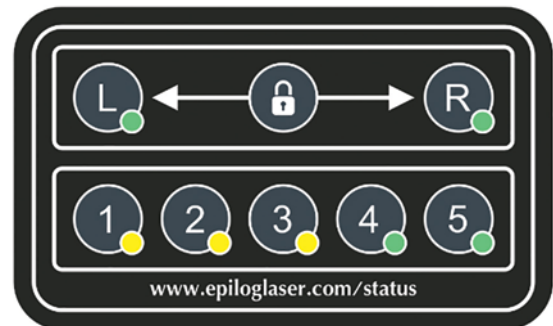

L	Left-hand interlock status indicator (green LED). If the indicator is on (illuminated), the left-hand safety interlock switch is closed.
R	Right-hand interlock status indicator (green LED). If the indicator is on (illuminated), the right-hand safety interlock switch is closed.
1	Fiber Laser Control signal indicator (yellow LED). This indicator represents the modulation ON and OFF applied to the fiber laser when executing a job.
2	Fiber Laser Enable signal indicator (yellow LED). This indicator shows the Enable signal which must be present (along with Control and M_OSC) for the fiber laser to operate. This signal is derived from the right-hand interlock status.
3	Fiber Laser M_OSC signal indicator (yellow LED). This indicator shows the Master Oscillator signal which must be present (along with Control and Enable) for the fiber laser to operate. This signal is derived from an internal fiber laser select signal and the left-hand interlock.
4	CO2 Laser Control signal indicator (green LED). This indicator shows the modulation ON and OFF applied to the CO2 laser. It is gated by an internal CO2 laser select signal and by the right-hand interlock.
5	CO2 Laser Enable signal indicator (green LED). This indicator shows the Enable signal which must be present (along with the Control signal) for the CO2 laser to operate. It is derived from the left-hand interlock.

### Rulers

The rulers have both English and Metric units printed on them. Simply unscrew the rulers and flip them over if you want to change which units are displayed.





# SECTION 11: OPTIONAL FEATURES

Vector Cutting Table/Vacuum Hold-Down Table

## Vector Cutting Table/Vacuum Hold-Down Table

### Vector Cutting Table

The optional Vector Cutting Table/Vacuum Hold-Down Table is primarily used for vector cutting jobs where the laser penetrates all the way through the material being cut. The Vector Cutting Table lifts your work material off of the flat task plate and allows the laser beam to penetrate all the way through the material without reflecting back up onto the backside of your work.

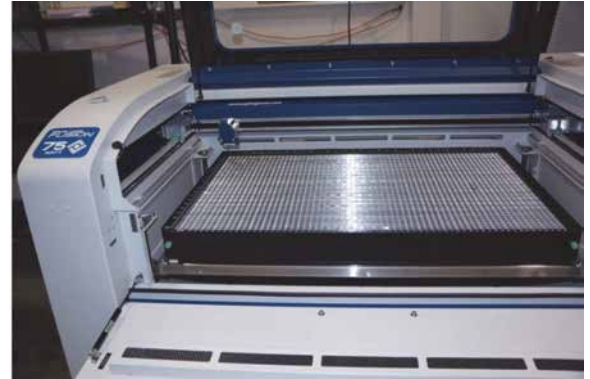

### Vacuum Hold-Down Table

The exhaust system is designed so that it evacuates from both the top and the bottom of the Vector Cutting Table. The exhaust pulls air through the grid and forms enough of a vacuum that it will flatten slightly warped sheet stock, paper, wood, aluminum sheet stock and other materials. As long as the exhaust is operating, and the Vector Cutting Table is no more than an inch (25.4 mm) below its highest point, the vacuum table will work. If you have a piece of sheet stock that does not flatten out because it is not covering enough of the grid holes, you can use any material (including paper) to cover the exposed grid. Simply blocking most of the grid holes will be enough to flatten most sheet stock as long as it is not too severely warped, bent or too rigid.

### Installation of the Vector Cutting Table

The rulers on the task plate have slots that align and hold the pins mounted to the bottom of the Vector Cutting Table. The photo shows the slots in the rulers between the 2" and 3" marks. There are four slots on the X-axis and 3 slots on the Y-axis. Simply align the pins in the bottom of the Vector Cutting Table to these slots and press the Vector Cutting Table firmly into the slots. You should feel a tactile "click" when the table is properly seated.



Whenever you are vector cutting there is the potential for small pieces to fall through the grid and collect in the bottom of the Vector Cutting Table. These small pieces present a very dangerous fire hazard. Remove and dispose of the debris in the Vector Cutting Table on a regular basis.

## Pin Table

The Pin Table option offers a method for users to keep all back reflections of the laser beam from marking the sides or back of the material being cut. The Pin Table lifts the cutting material completely off the table and provides a means to eliminate the tick marks that can be created when the laser beam comes into contact with the grid material.

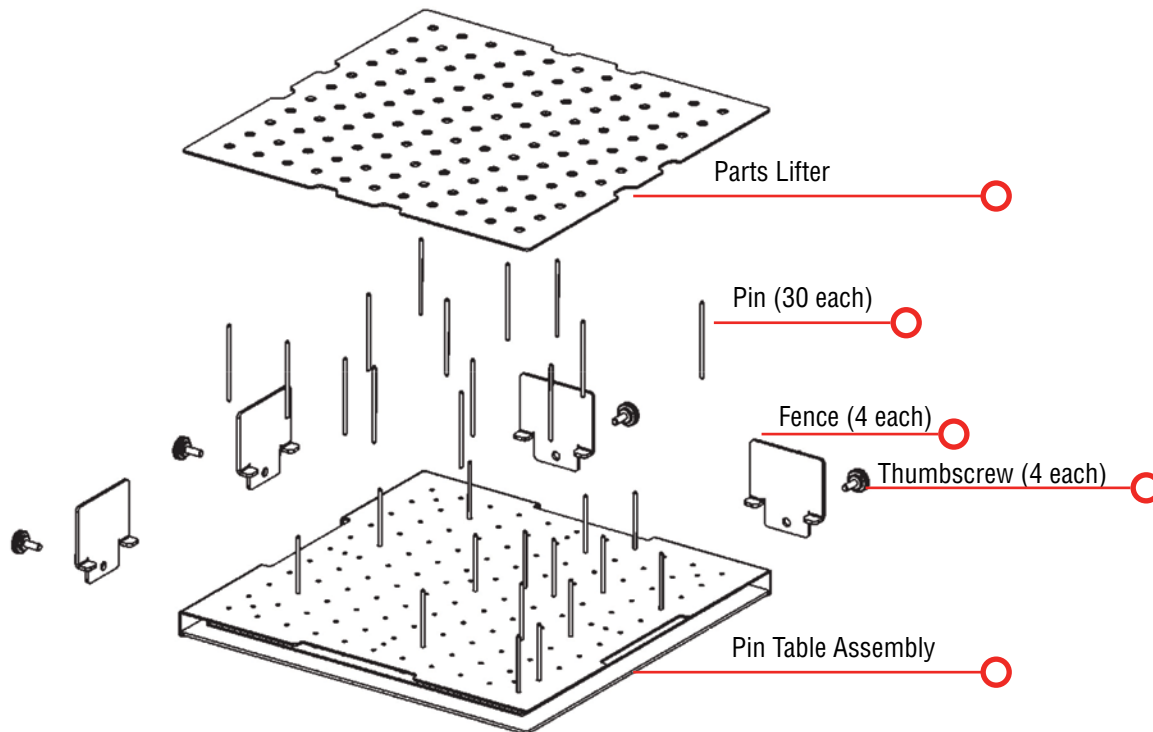

The Pin Table is a 12" x 12" (305 x 305 mm) anodized aluminum table that holds movable support pins that can be placed anywhere on the table's one inch (25.4 mm) grid pattern. The movable support pins allow the user to place the pins anywhere on the grid in such a way that they support the material being cut while avoiding the cutting path of the laser. This method of supporting the material produces cut edges that do not have any marks from laser reflections. By setting up a grid pattern in your graphics package to match the grid pattern of the Pin Table, you can easily ensure that your cutting path will not contact the support pins.

## Assembly Instructions

After unpacking the Pin Table, remove the four thumbscrews from the Pin Table assembly.

1. Install the four fences along the two sides using the thumbscrews you just removed.
2. At this point the Pin Table is almost ready to use. The next step involves placing the pins anywhere on the grid so that they support the piece you are going to be cutting, and are out of the laser beam cutting path.

## User's Guide

1. Install as many pins as necessary to support your work piece and waste pieces.



## SECTION 11: OPTIONAL FEATURES

- The pins are held in place with plastic supports and need to be pressed firmly into place to be fully seated. You may need to use a wooden block to press them in fully.
  - If all pins are not fully seated, the top of the pins will not be level and your work piece will wobble.
  - The grid design allows you to strategically place the pins where they will support your work piece and stay out of the lasers path at the same time.
2. Once the pins are located, place the pin table into the upper left corner of your laser system with the fences resting against the left and top edge guides (rulers). If the pin table is resting properly against the edge guides you will maintain your 0,0 (zero/zero) Home Position in the upper left corner.
  3. Once the pin table is in your laser system, place your work piece onto the pin table so that the left and top edges of your material rest against the fences.
  4. Send your job to the laser. If the pins are properly located, your job will cut all edges cleanly without the laser contacting any of the pins.
  5. When cutting is complete, use the handy Parts Lifter to lift your parts from the pin table.
  6. When you're ready for your next vector cutting job, you can remove the pins and place them into a new position. The pins are designed to be held snugly in place by the plastic supports. It may be necessary to remove them with the use of pliers.
  7. Additional pins can be purchased from Epilog. Ask for **P/N LF231**.
  8. The Pin Table is designed so that multiple Pin Tables can be set next to each other and maintain the 1" (24.4 mm) grid pattern.

### Using the Pin Table:

In CorelDRAW, set up a 12" x 12" (305 x 305 mm) page. Select **View**, scroll down and click on **Grid** and **Ruler Setup**.

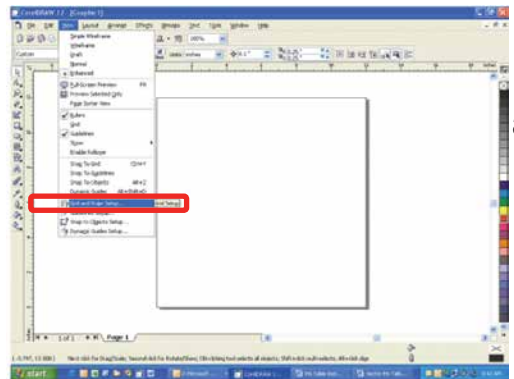

and

Set the Frequency to 1.0 per inch (both Horizontal and Vertical), and put check mark in the Show grid box. Click **OK**. Your Corel page now shows grid pattern that matches the grid of the Pin Table.

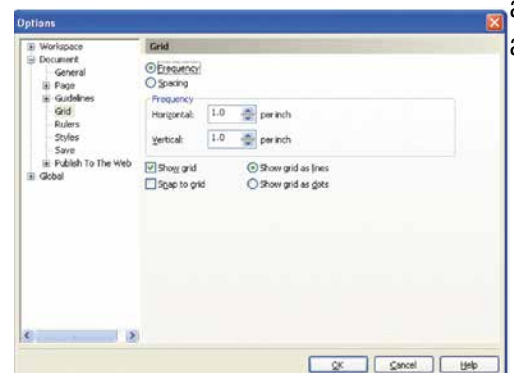

a  
a

## SECTION 11: OPTIONAL FEATURES

### Pin Table

Set up your artwork on the grid so that the vector lines do not cross the path of any of the pins. The small black circles within the letter “B” show the location of the pins. Notice that you do not need to place pins in every available space, they just need to be placed where they will support the work piece. For this piece we have also supported the middle of the “B” to show how to support the waste pieces if you do not want them to fall out after cutting. The circles outside of the “B” are to support the long piece of wood that we are going to use for cutting.

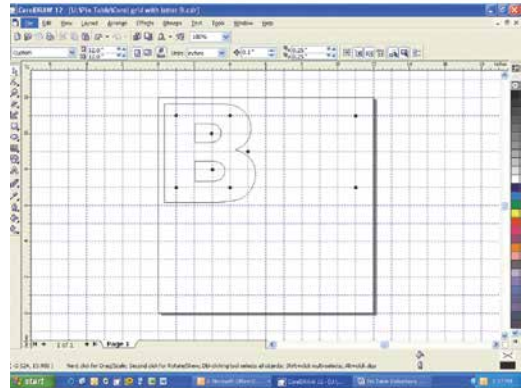

The next photo shows the Pin Table in the machine with the letter “B” cut out and resting on the pins.



## Fusion Rim-Drive Rotary Attachment

The optional Fusion Rim-Drive Rotary Attachment allows you to mark and engrave on cylindrical objects.

### Firmware Preparation

Make sure your Fusion firmware is version 1.0.0.7 or higher to operate the Rotary Attachment. The firmware version is one of the menu items under the Settings menu items on the Fusion Control Panel. To upgrade your firmware go to the Epilog web site at [www.epiloglaser.com/tech-support/epilog-drivers.htm](http://www.epiloglaser.com/tech-support/epilog-drivers.htm). Further instructions are available in “**Section : Upgrading the Operational Firmware**” on page 155.

### Rotary Attachment Installation

Lower the engraving table far enough so the Rotary Attachment will not interfere with the lens carriage.



**An important note:** Turn off the power to the engraver. It's important that the laser system is turned off before installing (or removing) the Rotary Attachment.

Place the Rotary Attachment in the upper left corner of the table so that the baseplate is positioned against the sides of the left and top rulers. The rotary rests on the table against the rulers and does not need to be locked in place.

With the Fusion powered off, mate both cable connectors to the connectors located at the right side of the cabinet as shown in the photo.



Once the Rotary Attachment cables are connected you can power on the laser system. The Fusion senses that the Rotary has been installed. During machine initialization the lens carriage will find its new Home Position over the center of the Rotary Attachment, as shown to the right.



## Initial Setup (Setting Home: First time use only)

New installations may need to establish the Rotary Home Position.

Install the rotary and power up the system. The X-beam will go through its standard power up sequence and will come to rest over the rotary. Turn on the **Red Dot Pointer** from the Control Panel (you may need to raise the table to focus the Red Dot Pointer). The red dot will show you the location of your Home Position. For proper operation, the Home Position should be at the front edge of the black bumper as shown below. If your red dot is not at this location, you will need to adjust the X and Y axis settings to establish the correct rotary Home Position.

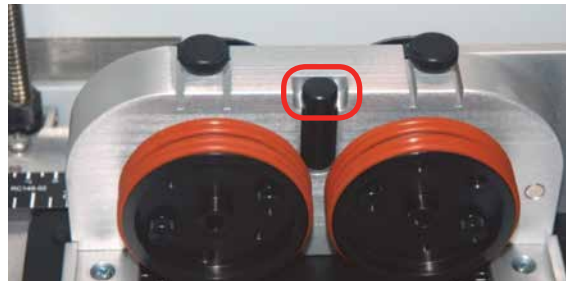

To establish the Rotary Home setting at the front of the black bumper we will use the Red Dot Pointer to show us where our Home Position is and then how far we need to adjust our settings. Once you have set and saved the X and Y Rotary Home Position you should not have to set it again.

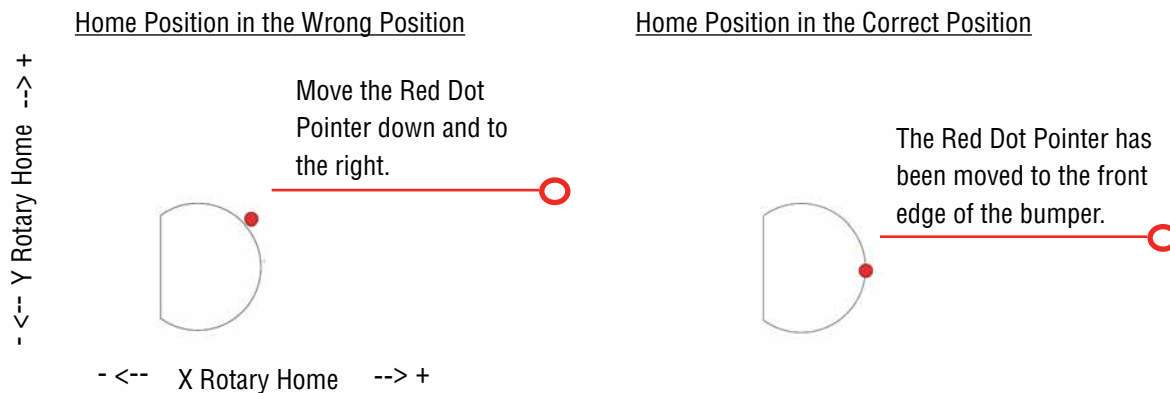

1. Turn on the **Red Dot Pointer** from the Fusion Control Panel.
2. Go to **Jog** on the Fusion Control Panel.
3. Use the **Joystick** to move the carriage so that the Red Dot Pointer is at the front edge of the black bumper.
4. The LCD on the Control Panel shows a digital readout of the location of the Red Dot Pointer. The number displayed on the left is the X-axis, the number on the right is the Y-axis. **Write down these two numbers including the plus or minus sign associated with each.**
5. Go to **Settings** on the Fusion Control Panel.

## SECTION 11: OPTIONAL FEATURES

6. Tilt the Joystick down to scroll to the **X Rotary Home** menu. New installations will show a value of 0.000.
7. **Center click the Joystick.** A flashing cursor will appear below the number displayed. **Tilt the Joystick** up or down to increment or decrement the number so that it matches the number you recorded above for the Red Dot Pointer X-axis value.
8. Press the **Go** key.
9. Use the **Joystick** to scroll down to the **Y Rotary Home** menu. New installations will show a value of 0.000.
10. **Center click the Joystick.** A flashing cursor will appear below the number displayed. **Tilt the Joystick** to increment or decrement the number so that it matches the number you recorded above for the Red Dot Pointer Y-axis value.
11. Press the **Go** key.
12. Use the **Joystick** to scroll back up to the **Restore XY Home** menu item.
13. **Center click** to save the new X and Y values. The carriage will now move back and to the left to establish a new Home Position. Your Red Dot Pointer should now be located at the front center of the black bumper.

### Rim-Drive Rotary Setup

The wheels on the left are the drive wheels which spin the cylinder. The wheels on the right are for support. The right side wheels are mounted on a scissor jack so they can be raised or lowered to level the top surface of your cylinder with the X-beam. The scissor jack can be moved left and right to accommodate cylinders of different lengths.

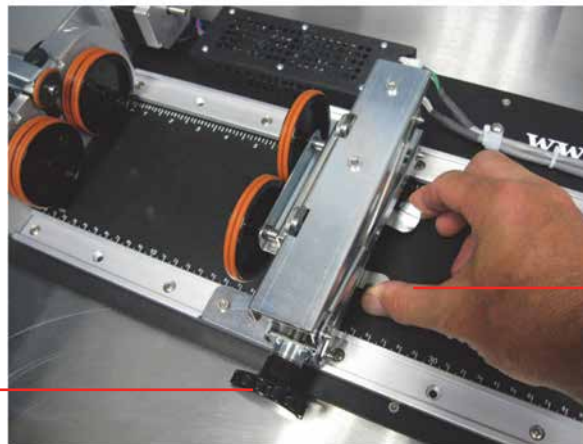

Rotate the knob to lift or lower the scissor jack.

Squeeze the tabs to move the scissor jack left and right.

## SECTION 11: OPTIONAL FEATURES

### Fusion Rim-Drive Rotary Attachment

In most cases you will want to load your cylinder with the larger diameter on the left (drive wheel side). The scissor jack is used to elevate the right side of your cylinder so that the top surface is horizontal. Load your cylinder onto the Rotary Attachment so that it is just touching the black bumper. Using the clamp to hold the glass in place is optional. Some odd shaped glasses rotate better if they are clamped to the drive wheels, but most glasses and other cylindrical objects do not require clamping.

This photo shows the clamp holding a glass against the drive wheels. Use the thumbscrews to adjust the clamp in and out.



Many glasses, like this one, do not require the use of the clamp. The clamp is used mostly for hard to rotate cylinders or very lightweight objects that need more than just gravity to hold them in place.



Use the scissor jack to raise the right side of the cylinder so that the engraving/cutting surface is horizontal. The photos below show the same flashlight at a severe angle to horizontal. If your cylinder is not horizontal to the X-beam the laser will lose focus as the carriage head moves across the flashlight. This causes the engraving quality on the right hand side to suffer dramatically.

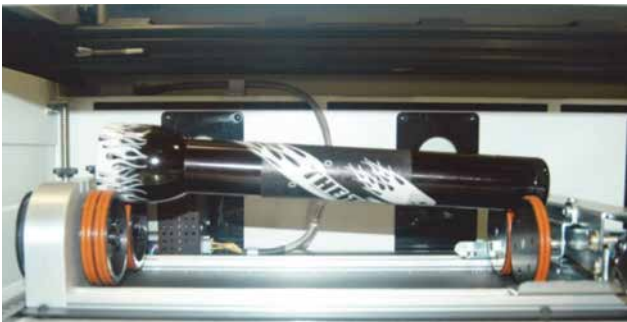

**Incorrect Setup:** The flashlight is not horizontal. Raise the right side of the flashlight by turning the jack screw.

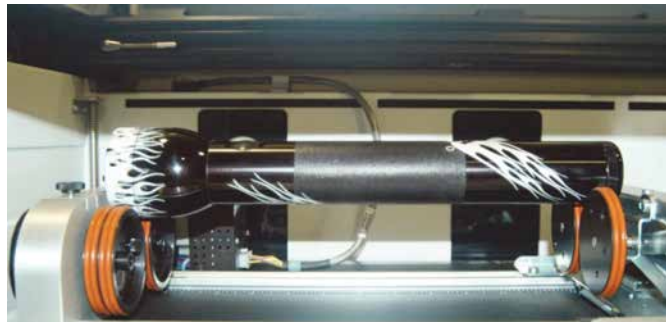

**Correct Setup:** The flashlight is horizontal to the X-beam

## Setting Focus with the Rotary Attachment

With your cylinder in place on the Rotary Attachment, place the focus gauge on the lens carriage and then scroll to **Focus** mode on the Fusion Control Panel. **Double center click the Joystick** to bring up the Focus submenu.



The sub-menu shows that a down tilt of the Joystick will “Moveout” the X-beam. The Moveout command will move the lens carriage back from Home so that the focus gauge is centered over the cylinder.

In addition to moving the lens carriage back the Moveout command also disables the X-motor. This allows you to move the carriage by hand in the X-axis (left to right). The Moveout function allows you to easily focus along the entire length of your cylinder. By moving the lens carriage back and forth and adjusting the scissor jack you are able to focus along the entire length of your cylinder. The following photo shows a typical setup for focusing on a mug with a handle. Notice that we used the scissor jack to raise the right end of the glass.



When you are finished focusing press the **Reset** key on the Control Panel. Pressing Reset will send the lens carriage back to its standard Home Position at the front of the black bumper. You are now ready to start the job.

## SECTION 11: OPTIONAL FEATURES

Fusion Rim-Drive Rotary Attachment

### Removing the Drive Wheel

The drive wheels are each two-piece assemblies when fully assembled. Removing the front part of the drive wheel enables the user to accommodate a wide variety of mugs with handles. Not all mugs with handles require the front drive wheels to be removed, but for certain types of mugs removing the front wheels adds flexibility to the Rotary Attachment.

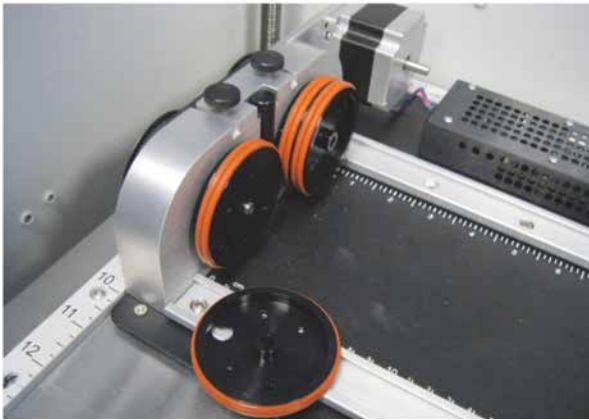

There are two small thumbscrews that attach each front drive wheel to the back drive wheel. Loosen the two small thumbscrews on each wheel to remove the front wheel.

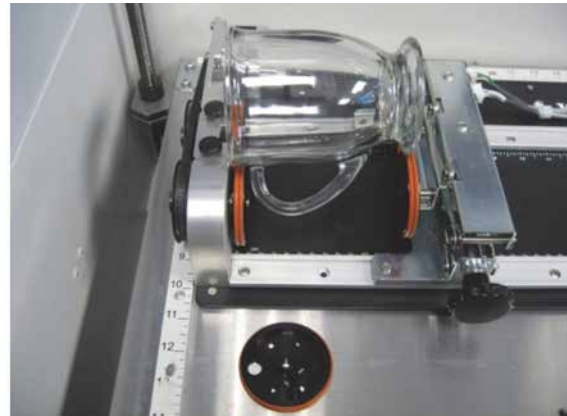

This photo shows a mug with a handle positioned on the Rotary Attachment with the removable portion of the drive wheel shown in the foreground.

### Artwork Layout

Because the Rotary Attachment automatically compensates for the diameter of the glass, artwork setup is relatively easy. The most important thing to remember when working with the rotary is that your artwork needs to be rotated 90 degrees to the way it would normally be setup for flat work. There are several visual tools later in this procedure that will help make artwork setup easy.

1. **Set the width of your page (in the X direction) to the length of the glass you are engraving.** For this glass the width of the page is 6" (152 mm).
2. **Set the height of your page (in the Y direction) to the circumference of the glass you are engraving.** Use a flexible tape measurer to find the circumference of the glass at its largest diameter. For this glass, the height of the page is 11" (279 mm).





## SECTION 11: OPTIONAL FEATURES

3. **Place your artwork close to the top edge of the page.** When the job starts, the first part of the process is for the cylinder to rotate through any white space that is between the top of your page and the top of your artwork. Once it has rotated through the white space it will begin to laser your artwork.

The edge of the black bumper on your Rotary Attachment corresponds to the left edge of your page in CorelDraw. Set your cylinder on the Rotary Attachment so that it just touches the black bumper. The “top” of a cylinder can be at either end of the Rotary Attachment. It is useful to visualize the orientation of the cylinder when it is being engraved.

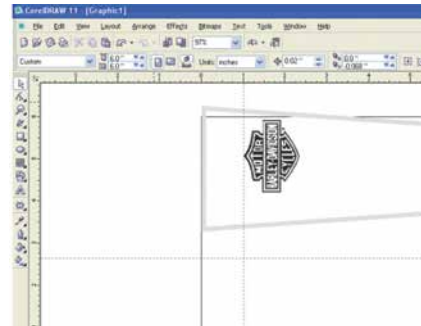
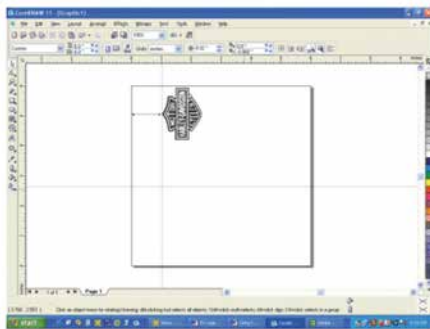

In this example, the bottom of the logo will engrave 4” (100 mm) up from the bottom of the bottle.

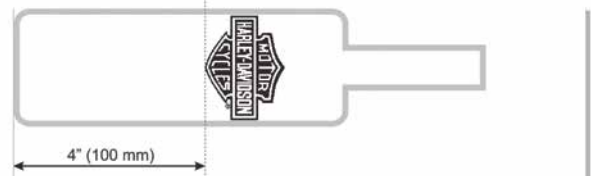

### Stretching or Shrinking Your Artwork for Objects with Multiple Circumferences

The instructions below show you how to shrink or expand your artwork to accommodate a cylinder where the area being engraved is a different circumference than the circumference at the drive wheels. The Rotary Attachment works with the assumption that the cylinder is the same circumference from end to end and that your artwork doesn't need to be stretched. But some cylinders have a big difference in circumference from the middle to the end that affects how the engraved image looks. It is sometimes necessary to stretch or shrink your artwork so it looks proportional on odd shaped items. The photo below shows a glass that fits this category.

This glass has a circumference of 4” (100 mm) at the ends and a circumference of 3.2” (81 mm) in the middle where we want to engrave. Most artwork will look acceptable on this glass without stretching or shrinking, but because the middle of the glass is a smaller diameter than the ends, some artwork will look compressed (more as an oval than a



## SECTION 11: OPTIONAL FEATURES

### Fusion Rim-Drive Rotary Attachment

circle), so we'll want to adjust the artwork before engraving. To determine how much to adjust your artwork, we'll need to do a simple calculation that tells us the percentage of stretch or shrinkage we need to perform. You can use either the diameter or the circumference to make the calculation; just don't mix the two.

Determining whether you use diameter or circumference is a matter of which one is easier to measure. If you want to measure circumference, use a flexible ruler and wrap it around the glass. To calculate circumference, measure the diameter and multiply by Pi (3.1416):

**Circumference = Diameter x 3.1416.**

#### For objects with a larger middle section:

Shrink the artwork by dividing the drive wheel side diameter by the middle diameter and multiply by 100 to calculate the percentage of adjustment. For our example the calculation is:

$$\frac{3''}{4.2''} = .715 \times 100 = 71.5\%$$

Because our calculation percentage is less than 100, we need to shrink the artwork to 71.5% of its original size. Adjust the size of your artwork in one axis only.

#### For objects with a smaller middle section:

Expand the artwork by dividing the drive wheel side diameter by the middle diameter and multiply by 100 to calculate the percentage of adjustment. For our example the calculation is:

$$\frac{3.5''}{2.7''} = 1.296 \times 100 = 129.6\%$$

Because our calculation percentage is greater than 100, we need to expand the artwork to 129.6% of its original size. Adjust the size of your artwork in one axis only.

#### Other considerations:

In these two examples you'll notice that the "middle" varies depending on where you measure. Because of this, you'll never be able to get every piece of artwork perfectly sized. Depending on how much room the artwork takes up, you may want to experiment with the expansion or shrinkage of your artwork to fit your particular glass shape.

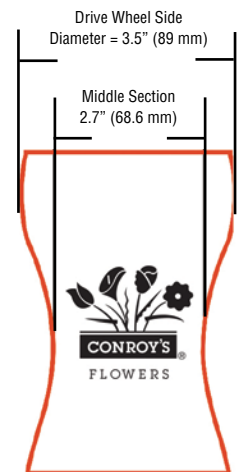
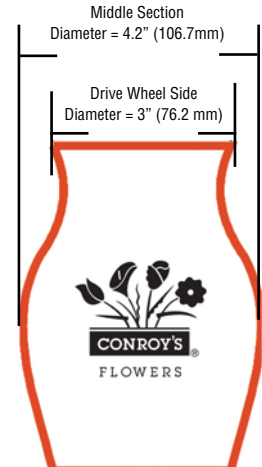

## Rotary Removal

1. **Turn off the power** before removing the Rotary Attachment.
2. **Unplug and remove** the Rotary Attachment.
3. **Turn on the machine** and the Home Position will return to the 0,0 point.

### 3-Jaw Chuck Rotary Attachment

The 3-Jaw Chuck style rotary is an extremely versatile tool for marking and engraving cylindrical objects. It comes with a variety of interchangeable components that make it easy to hold different sized and shaped cylinders. There are two basic setups:

1. 3-Jaw Chuck
2. Fixture plates

This photo shows the basic setup with the 3-Jaw Chuck on the left and the centering fixture on the right.



This photo shows the 3-Jaw Chuck style Rotary Attachment with the large fixture plates installed.

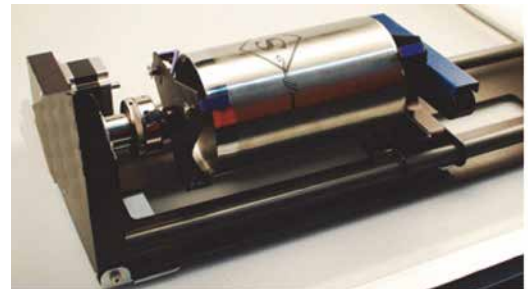

### Fixture Plates and Additional Components

The following fixture plates and additional components are included with all 3-Jaw Chuck Rotary Attachments

1. Small fixture plates (2 each)
2. Large fixture plates (2 each)
3. Idle-side centering fixture (1 each)
4. Plate spindle (1 each)
5. Plate fixture thumb screws (2 each)
6. 3-Jaw tightening pins (2 each)
7. 3" Lens for CO2 Fusion only. Always install this 3" lens whenever using the 3-Jaw Chuck style rotary in the CO2 Fusion. Use the standard 2" lens for all non-3-Jaw Chuck Rotary jobs.

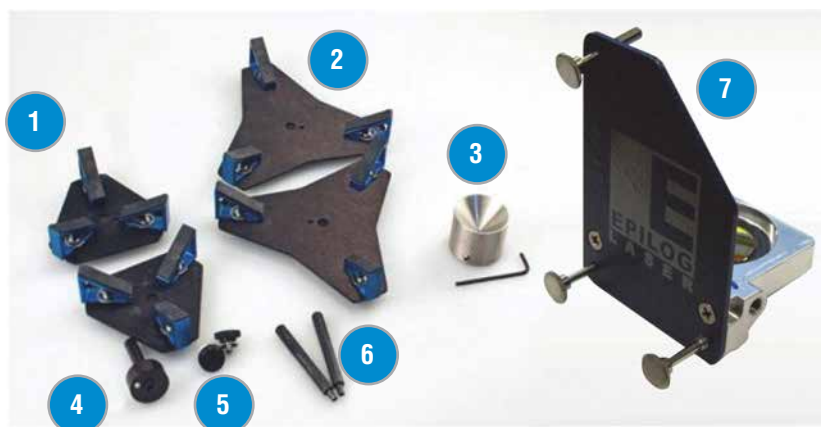

# SECTION 11: OPTIONAL FEATURES

## 3-Jaw Chuck Rotary Attachment

### Firmware Preparation

Make sure your Fusion firmware is version 1.0.0.9 or higher to operate the Rotary Attachment. The firmware version is one of the menu items under the Settings menu items on the Fusion Control Panel. To upgrade your firmware follow the instructions at “**Section : Upgrading the Operational Firmware**” on page 155.

### 3-Jaw Chuck Rotary Attachment Installation

1. Install the 3” lens.
2. Lower the engraving table to its lowest point.
3. Turn off power to the Fusion.

These are explained in detail in the following section.

**Important!** It is important that you power down the machine before inserting the rotary connector at the table. The Fusion laser system will not recognize the Rotary Attachment until the system is rebooted and you could damage the electronics if the rotary is installed while the laser system is powered on.

### 3” Lens Installation

When installing the 3-Jaw Chuck, install the 3” lens included with the additional components. The CO2 Fusion 3-Jaw Rotary Attachment requires the use a 3” lens. The crash bar on the standard 2” lens on the CO2 Fusion interferes with the Rotary Attachment and cannot be used.



If you have the dual-source CO2 and Fiber laser, the system comes with a 3” lens already installed. There is no need to change lenses.

1. Remove the standard 2” lens. Notice that the 2” lens incorporates the crash bar and the Air Assist tube.

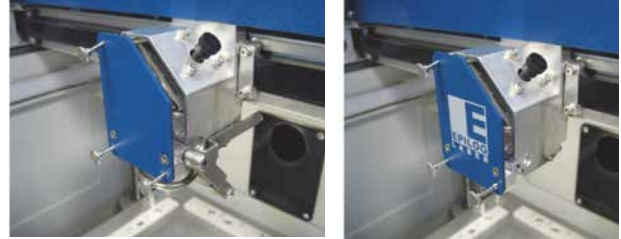

2. Install the 3” lens. Notice that the 3” lens does not include the Crash Bar or Air Assist tube.

#### Lower Table and Turn Off Power

1. Lower the engraving table to its lowest point.
2. Turn off power to the Fusion.

**Important!** It is important that you power down the machine before inserting the rotary connector at the table. The Fusion laser system will not recognize the



Rotary Attachment until the system is rebooted and you could damage the electronics if the rotary is installed while the laser system is powered on.

3. With the Fusion powered off, place the Rotary Attachment so that the baseplate butts up tight against the left-side and upper rulers.

## SECTION 11: OPTIONAL FEATURES

### 3-Jaw Chuck Rotary Attachment

4. Insert both connectors into the receptacles on the right side of the machine.

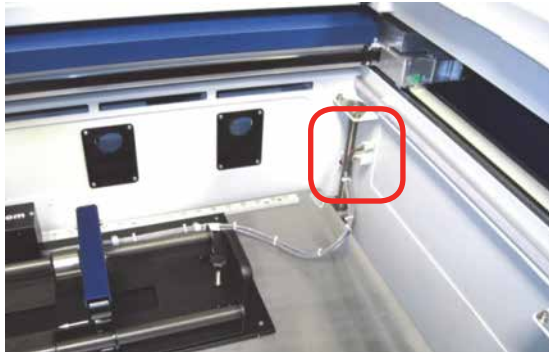

5. Once the Rotary Attachment is plugged in you can power on the Fusion.
6. When the Fusion powers on with the Rotary Attachment installed, the carriage moves to the Rotary Home Position, which is directly above the 3-Jaw Chuck.

### Initial Setup (Setting Home - First Time Use Only)

New installations may need to establish the Rotary Home Position. The following instructions show how to set a Home Position for the 3-Jaw Rotary Attachment. For most users this is not necessary because they set a new Home Position for every rotary job they run using the Center-Center engraving feature in the driver. Center-Center engraving is explained later in these instructions. The concept of why Center-Center is used is hard to explain, but rest assured that it will become obvious on your very first 3-Jaw Chuck Rotary job.

Install the rotary and power on the system. The system will go through its standard power up sequence. The carriage will come to rest directly over the rotary instead of in the upper left corner and the table will move to its lowest position.

Turn on the **Red Dot Pointer** (you will need to raise the table to focus the Red Dot Pointer). The red dot will show you the location of your Home Position. For proper

operation most users set the Home Position at the edge of either the clamp or the jaws. However, depending on your specific application it can be set anywhere you want. Our experience shows that most users prefer the edge of the jaws.

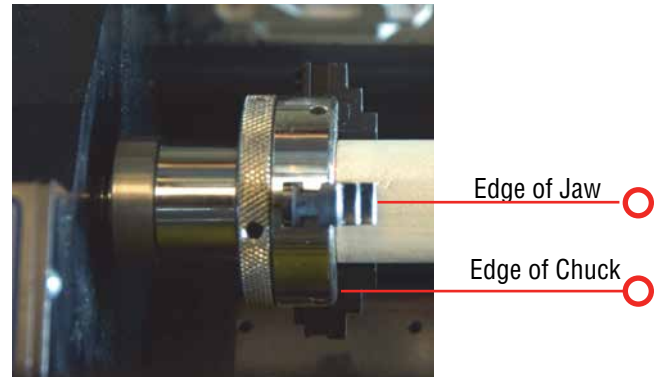

Your X-Home Position defines the left edge of your page in your graphics software.

To establish the Rotary Home setting at the edge of the jaws we will use the Red Dot Pointer to show us where our Home Position is and then how much we need to adjust our settings.

1. Turn on the **Red Dot Pointer** from the Fusion Control Panel.
2. Go to **Jog** on the Control Panel.
3. Use the **Joystick** to move the carriage so that the Red Dot Pointer is at the front edge of the jaws or the clamp. Make sure the red dot is also centered front to back. This exercise is easier to perform if you have a cylinder in place.
4. The LCD on the Control Panel shows a digital readout of the location of the Red Dot Pointer. The number displayed on the left is the X-axis, the number on the right is the Y-axis. **Write down these two numbers** including the plus or minus sign associated with each.
5. Go to **Settings** on the Fusion Control Panel.
6. Tilt the Joystick down to scroll to the **X R Home** menu. New installations will show a value of 0.000.

## SECTION 11: OPTIONAL FEATURES

### 3-Jaw Chuck Rotary Attachment

7. **Center click** the Joystick. A flashing cursor will appear below the number displayed. Tilt the Joystick up or down to increment or decrement the number so that it matches the number you recorded above for the Red Dot Pointer X-axis value.
8. Press the **Go** key to Save the setting.
9. Now, tilt the Joystick down to scroll to the **Y R Home** menu. New installations will show a value of 0.000.
10. **Center click** the Joystick. A flashing cursor will appear below the number displayed. Tilt the Joystick to increment or decrement the number so that it matches the number you recorded above for the Red Dot Pointer Y-axis value.
11. Press the **Go** key to Save the setting.
12. Tilt the Joystick up to scroll back to the Restore XY Home menu item.
13. **Center click** to save the new X and Y values. The carriage will now move back and to the left to establish a new Home Position. Your Red Dot Pointer should now be located at its new location.

Once you have set and saved the X and Y Rotary Home Position you should not have to set it again, but you can always use the procedure above to adjust your Home Position.

**Note:** Many users do not worry about a fixed Home Position on the clamping style rotary. Instead users find that each new rotary job requires an entirely different clamping method than the last and setting a fixed Home Position just isn't important. Instead, they use the Center-Center feature in the driver and establish a new Home Position for each job. This is easy to do.

1. Clamp your cylinder into the Rotary Attachment.
2. Focus on your cylinder.
3. Turn on the **Red Dot Pointer**.
4. Use the **Jog** feature to move the red dot to a point

along your cylinder that defines the center point of your mark.

5. Center click to set that point as your Home Position.
6. Use the Center-Center feature in the driver when you are ready to print.

For more information on the Center-Center feature please refer to "**Center Engraving**" on page 105 in this owner's manual.

### 3-Jaw Chuck Rotary Attachment Setup

1. **Measure your Cylinder:** the cylinder diameter will be used in the print driver.



2. **Adjust the Rotary for Cylinder Length:** depress the blue anodized idle-side handle to move the support mechanism left or right to accommodate different length cylinders. There are photos later in this section that show the different configurations available for the Y-Axis idle side support.



## SECTION 11: OPTIONAL FEATURES

### 3-Jaw Chuck Rotary Attachment

3. **Clamp your Cylinder:** insert your cylinder into the 3-Jaw Chuck and tighten the chuck so the cylinder is held firmly in place.

You will need to use the two tightening pins that are provided with the chuck in order to clamp the cylinder tightly into place.



Cylinders can be held from the outside diameter or the inside diameter.

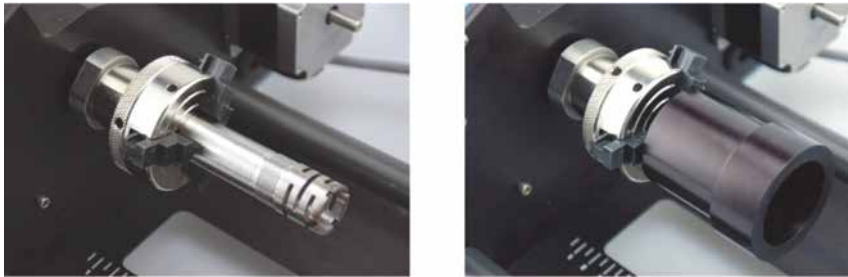

The chuck jaws can be flipped from Standard mode to Wide mode (180 degrees) to accommodate larger radius cylinders.

Notice that there is a stamped number on each side of each jaw and next to each slot. For wide-radius turning, simply remove jaws 1 and 3, flip them, and then insert jaw 1 into slot 3 and jaw 3 into slot 1. Remove jaw 2, flip it and return it to slot 2. The jaws do not need to be inserted all the way just yet. You will need to rotate the cam to capture the jaws in ascending order (1,2,3). Rotate the cam so that it catches jaw 1 first, then jaw 2, then jaw 3.

Pay particular attention to aligning the numbers as shown on the diagram when flipping the jaws! Failure to align the correct jaw in the correct slot will result in uneven spacing of the jaws when they are tightened.

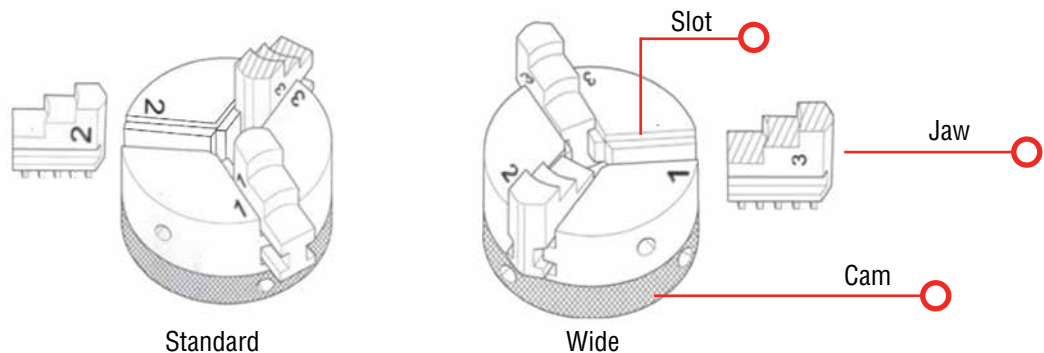

## 3-Jaw Chuck Diameter Capacities

The 3-Jaw Chuck allows four different ways to hold your object based on cylinder diameter and whether you are holding it from the inside or outside diameter.

	Jaws in Standard Mode	Jaws in Wide Mode
Piece Held From Inside Diameter	0.875" to 3" (22.2 to 76.2 mm)	2.125 to 3.125" (54 to 79.4 mm)
Piece Held From Outside Diameter	0.040" to 1.25" (2.54 to 31.7 mm)	1" to 3" (25.4 to 76.2 mm)

## Vector Speed Limitations based on Cylinder Diameter

**Important!** There are speed limitations in Vector mode based on cylinder diameter. The driver will display the maximum speed setting that can be used for a given diameter. Your power setting will need to be adjusted according to the speed.

The 3-Jaw Chuck Rotary was designed to rotate cylinders that range in size from 0.040" (12.7 mm) to approximately 3" (76.2 mm) in diameter. However, from a practical point-of-view, it is difficult to produce a legible mark on cylinders that are smaller than .080" (2 mm).

## Set the Cylinder Diameter in the Driver

With the rotary installed, the diameter measured, and the cylinder held tightly in place, you are ready to print.

1. Select the 3-Jaw Chuck option in the Laser Dashboard's General Tab.
2. Notice that for small diameter cylinders the driver limits the Vector speed in Vector mode only. Larger diameter cylinders do not have speed limitations.

## 3-Jaw Chuck Focus

With your cylinder in place on the Rotary Attachment, place the focus gage on the lens carriage and then scroll to **Focus** mode on the Fusion Control Panel. The carriage will move back after one second so that the focus gage is centered over your cylinder.

When you are finished focusing press the **Reset** key on the Control Panel. The lens carriage will go back to its standard Rotary Home Position. You are now ready to start the job.

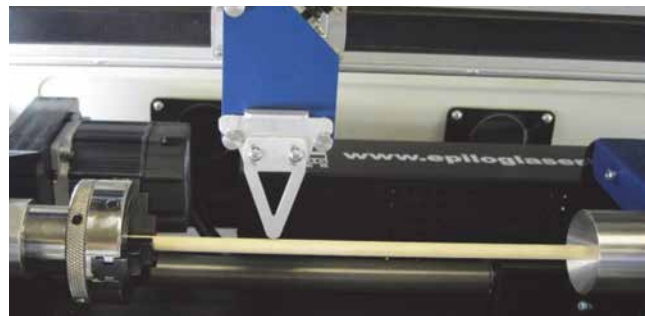



# SECTION 11: OPTIONAL FEATURES

## Additional notes about focusing with the rotary.

- The 3-Jaw Chuck Rotary was designed to use manual focusing only. While Auto Focus can be used, it is impractical for everyday use.
- When you are in Focus mode, the entire X-beam and carriage can be moved by hand. Normally, users will move only the carriage to a point along the long axis to focus. It is uncommon, but occasionally users will move the entire X-beam back and forth by hand. Use caution when moving the X-beam!
- After you have finished focusing, pressing any key on the Control Panel will reset the carriage back to its standard Rotary Home Position.
- The standard sub-menu items are available in Rotary Focus mode:



## Artwork Layout

Set up a custom page size in your engraving software that will accommodate the length and circumference of your cylinder. To set up your page in Corel, measure the length of the cylinder you are engraving. Use this as the minimum size of the horizontal dimension of your page. Measure the diameter of the cylinder and multiply this number by Pi (3.1416) to determine the circumference of the cylinder. Use the circumference as the minimum size of the vertical dimension of your page.

The actual size of the page is not overly important. If you have a cylinder that's 5.23" (133.8 mm) long with a circumference of 2.3" (56.7 mm), use a page that's slightly larger, say, 6" x 3" (152 x 76 mm).

This image shows a page size of 6" x 3" (152 x 76 mm). The gray inner rectangle represents the cylinder that is 5.23" x 2.3" (133.8 x 56.7 mm). Insure your artwork fits within the cylinder size.

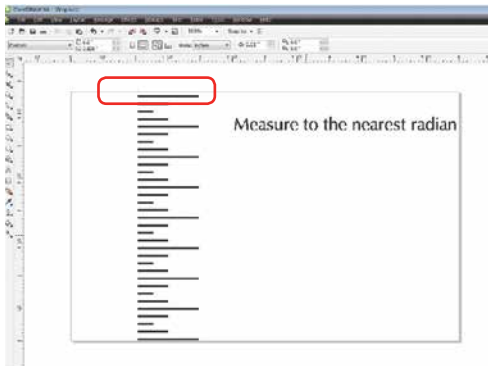
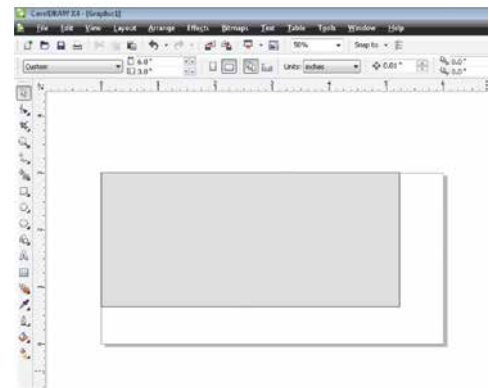

It's important that you set up your artwork so the top of the artwork is as close to the top of the page as you can comfortably place it.

Any white space between the top of the page and your artwork is considered part of the print job and your cylinder will rotate that amount until it reaches the first point of engraving.

## SECTION 11: OPTIONAL FEATURES

### 3-Jaw Chuck Rotary Attachment

#### Rotary Removal

1. Turn off power to the laser.
2. Open the door.
3. Depress the release tabs on the connectors and unplug the connectors.
4. Remove the Rotary Attachment.

#### Using the Fixture plates and additional rotary components

The 3-Jaw Chuck Rotary comes with additional attachments that make it easy to hold different sized and shaped cylinders. The photos below show different configurations that can be used to hold a wide variety of cylinders. The components can be mixed and matched. There is no single, correct method of holding a cylinder.

#### Attaching the Fixture Plate to the Chuck

Secure a large or small fixture plate to the spindle using one of the plate thumb screws.



The fixture plate will look like the photo when the spindle is assembled.

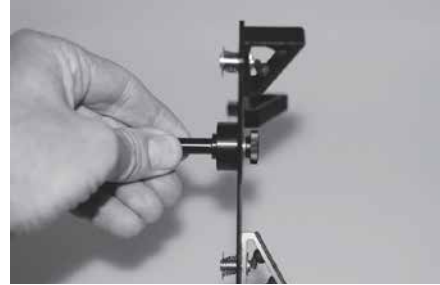

Slide the spindle into the chuck. Make sure the spindle is fully inserted into the chuck, then secure it using the chuck tightening pins.

Be sure to check that your Home Position is where you need it once the fixture plate has been installed.

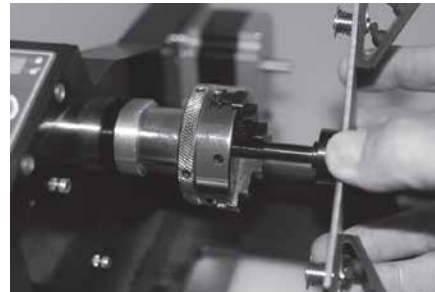

#### Attaching the Idle-Side Centering Fixture

The idle-side centering fixture is used to hold small diameter cylinders in place. It can be removed if the fixture plates are required for larger diameter cylinders. Remove or install it using the supplied hex wrench.



## SECTION 11: OPTIONAL FEATURES

3-Jaw Chuck Rotary Attachment

### Attaching the Idle-Side Fixture Plates

The fixture plates can be used on both the chuck side of the rotary as well as the idle-side. Attach the plate by placing it on the idle-side spindle and securing with a thumb screw.



The splines on all the fixture plates can be reversed to accommodate parts using the inside diameter (ID) or outside diameter (OD). To reverse the spline orientation, pull the spring-loaded splines away from the plate and rotate them 180 degrees.



This photo shows the small idle-side plate fixture. The small plate fixture can accommodate sizes up to 1" in diameter.

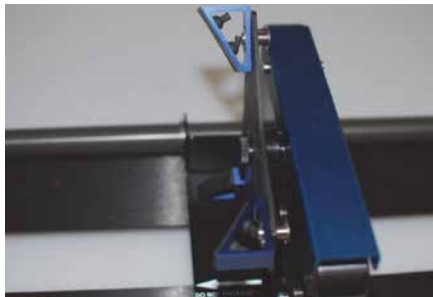

### Different Configurations for Fixturing Cylinders

This photo shows a typical example of a part that might be used with the 3-Jaw Chuck on the left side and the small idle-side plate fixture on the right.

This configuration is used when the cylinder diameter on the right side is too large for the centering fixture.

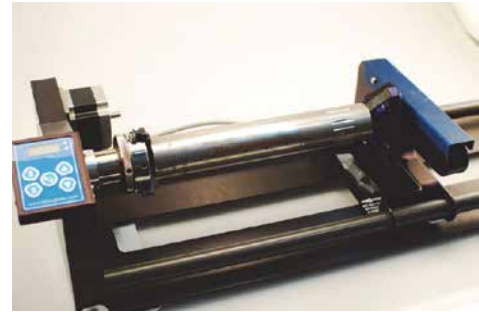

This photo shows a typical example of a larger part that requires a fixture plate on both the left and the right sides. Notice that the left side fixture plate is held in place with the 3-Jaw Chuck.

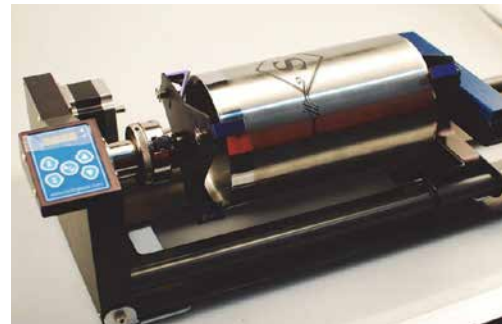

This photo shows the standard 3-Jaw Chuck on the left side and the idle-side centering fixture on the right. The idle-side centering fixture can accommodate sizes up to 1" in diameter.



The centering fixture is used to support small diameter parts that sag when held in place using only the 3-Jaw Chuck.



Some parts do not need the idle-side centering fixture for support and can be held using only the 3-Jaw Chuck.

### 3-Jaw Chuck Quick Start Guide

1. Lower the table far enough to accommodate the Rotary Attachment.
2. Turn off the machine.
3. Install the 3" lens.
4. Plug in the Rotary Attachment and position it in the upper left corner of the table.
5. Power up your laser.
6. Set up your artwork.
7. Print, and go to the Preferences window to set your laser parameters
  - Select Center-Center engraving mode.
  - Deselect Auto Focus.
  - Select the 3-Jaw Chuck option.
  - Input your cylinder diameter.
  - Set your Speed, Power, and other laser parameters.
  - Send the job to the laser.
8. Focus - Most users prefer to manually focus when using the 3-Jaw style rotary.
  - Press the Focus key on the Control Panel.
  - One second after pressing the Focus key the carriage will move back and to the right which places the manual focus gage directly over your cylinder.
  - Use the Joystick to move the table up and down to focus on your cylinder.
  - You can move the carriage by hand to focus anywhere along the length of your cylinder. You can also move the entire X-beam front and back by hand when the rotary is installed. Use caution when moving the beam by hand.
  - Press any menu key to exit Focus. The carriage and beam will move back to their Home Position.
9. Set Home
  - Press the **Jog** function on the Control Panel.
  - Turn on the Red Dot Pointer.
  - Use the Joystick to move the pointer to the point on your cylinder where you want your Home Position to be located.
  - Center click the Joystick to set a Home Position.
  - If desired, **double center click** to bring up the standard Jog sub-menu.
10. Close the top access door.
11. Press the **Go** key to start your job.

## eView Camera Module

The eView Camera Module is an option available only on the Fusion M2. By printing registration marks on your project, the camera system will align your artwork with the cutting and engraving in your project file for the most precise cutting alignment available.

### Attaching the eView Camera System to Your Computer

The eView Camera Module Accessories Kit includes:

- Preprogrammed Router
- Three Ethernet Cables
- One USB Cable

The camera module uses both USB and Ethernet communication that is optimized with an included, preprogrammed Gigabit router to handle the largest amounts of video data at the fastest speeds. Follow the four steps below to connect the laser, the router and the computer. All four cables must be connected to use the camera system.

- 1 Attach an Ethernet cable from a LAN port on the router to the Ethernet port on your computer. If you do not have an Ethernet port available, you can use a USB to Ethernet connector.
- 2 Attach an Ethernet cable from a LAN port on the router to the Ethernet port above Camera Out (on the back of the Fusion).

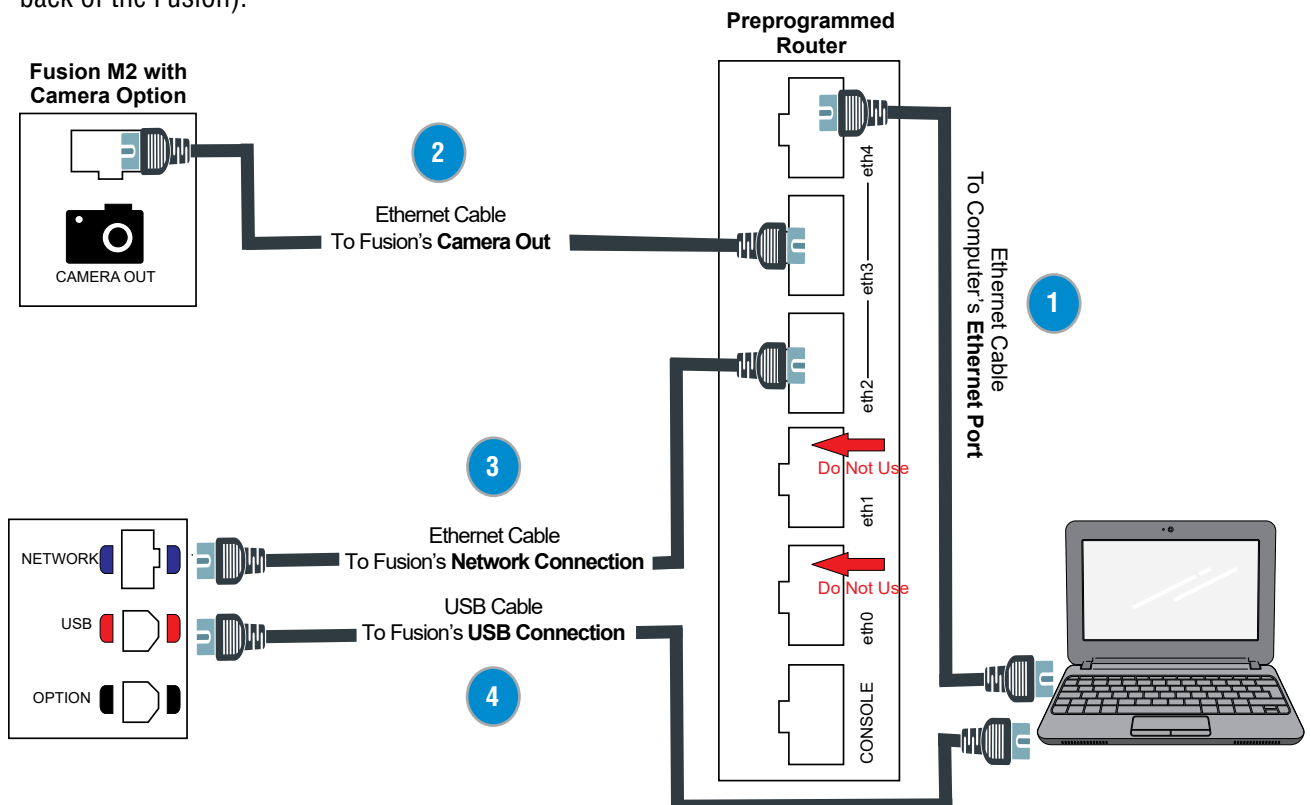

- 3 Attach an Ethernet cable from a LAN port on the router to the Network connection on the back of the Fusion.
- 4 Attach the USB cable from the USB connection on the back of the Fusion to a USB connection on your computer.

## Setting Up the Print File

Start by printing your artwork on acrylic, paper, cardstock, fabric, etc. On the printed artwork, include two registration marks that will allow the camera system to detect where on the laser bed your piece is located.

1. Each registration mark should be a 1/4" (6.35 mm) black, filled circle. Larger circles can be used, but .25" is the default.
2. The registration marks are vital to your printed artwork and provide a common point of reference between your graphic file, your printed material and the location of your printed material on your laser bed.
3. There are no hard and fast rules governing where the registration marks should be placed. It is preferable if they are placed on opposite sides of the graphic image.
4. When creating your artwork for printing you should overprint the outside edges of your artwork by approximately .060" (1.5 mm). The overprint area provides extra space to accommodate the cutting width of the laser beam.

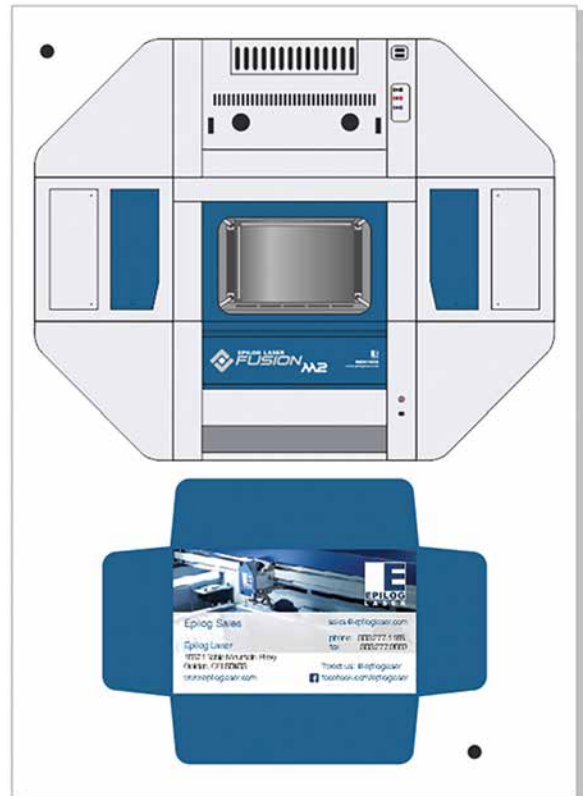

## Setting Up the File for Vector Cutting

Once we have our print file we need to add outlines to the registration marks and add vector cutting lines over the print file.

1. **Select the Registration Marks (Fiducials):** First, select each of the registration marks and give them a RGB outline color that will match one of the six basic colors available in the Color Mapping section of the driver (red, green, blue, cyan, yellow, magenta). In this example we used the color green. For more information on the colors available, see **“Color Mapping” on page 97.**



**Make sure you do not print these cutting lines on your printed item. These lines are only used with the laser!**

2. Create your vector lines and give them a separate color to be color mapped. In this example we used red for our cut lines and blue for our score lines. If you have different lines you would like to cut with different speeds and/or powers, give each of the lines a different RGB color.



**All vector cut lines and registration mark outlines must use RGB values.**

3. By placing your vector lines and printed items on different layers, you can quickly turn off the printed layer in the Object Manager so you can more easily print only the vector lines to the laser.

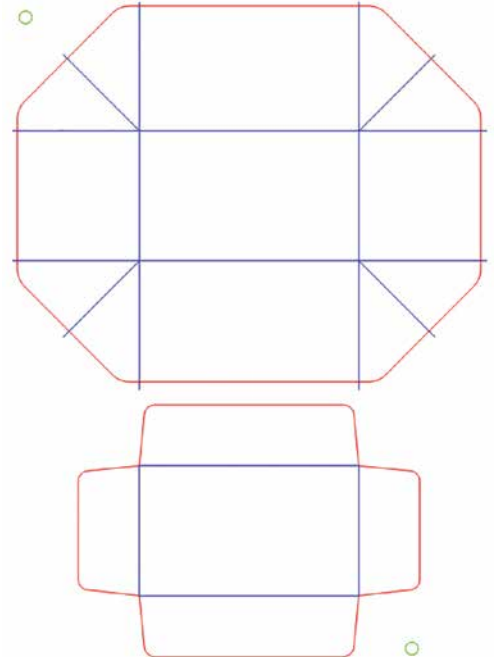
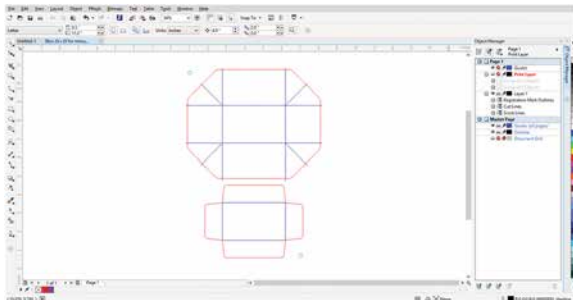

4. When you have your vector file prepared, choose **File > Print**. Go to **Preferences** and set your laser parameters, making sure that **Send to Manager** is checked.
5. For eView Camera jobs you must use Color Mapping. In the Color Mapping Tab, set your laser parameters for your cut lines. For instructions on setting Color Mapping settings, see **“Color Mapping” on page 97** in your manual.
6. You do not need to change the settings for the color you have assigned to the registration marks (green in this example) because they will not be processed as vectors. They are used only to identify which circles are registration marks.

# SECTION 11: OPTIONAL FEATURES

- Click **OK** to close the Preferences window and **OK** again to send the job to the Job Manager.

## Setting Up the Job in the Epilog Job Manager

- Place your item to be cut on the laser's table. **Make sure to leave the door to the laser open.** This allows the door cameras to show the table preview.

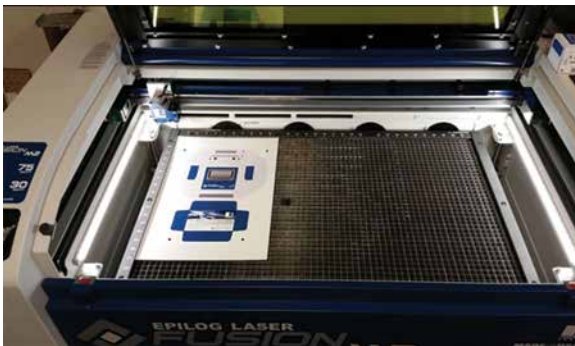

- Open the Epilog Job Manager. In the **Jobs Tab**, double click on the job you just printed to open the Job Information window.

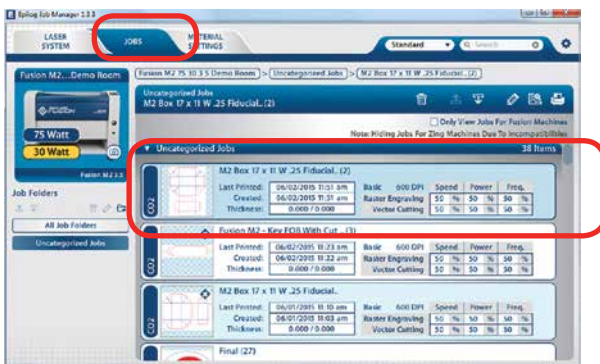

Make sure that when you set up your laser in the Job Manager that you checked the box to activate the eView Camera. For more information, see **“Activate a Laser” on page 36.**

- Designate the Registration Mark Color:** Click the **Colors Tab**. Find the color that represents the registration marks (green in this case). In the field at the far right (with a registration mark icon) click on the word **OFF** to toggle it to **ON**.

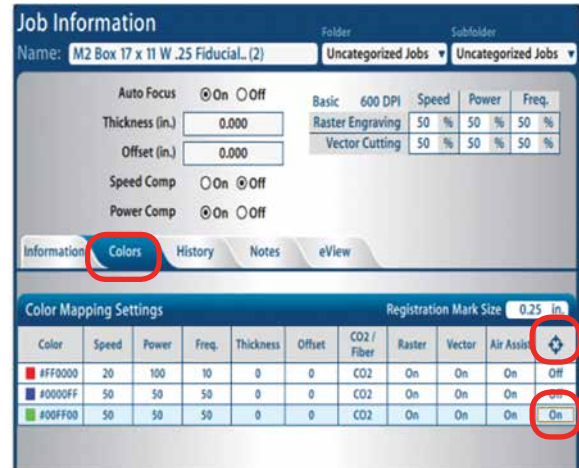

As soon as you click the Registration mark to ON the carriage will move as far back and to the left as it can go. This indicates that the Fusion is ready for the next step.

- Set Registration Mark Size:** After selecting the registration mark color, a field will appear allowing you to set the registration mark size. The default is .25” (6 mm), like we used in the file setup.

If you used a different size circle in your artwork setup you can designate that size here.

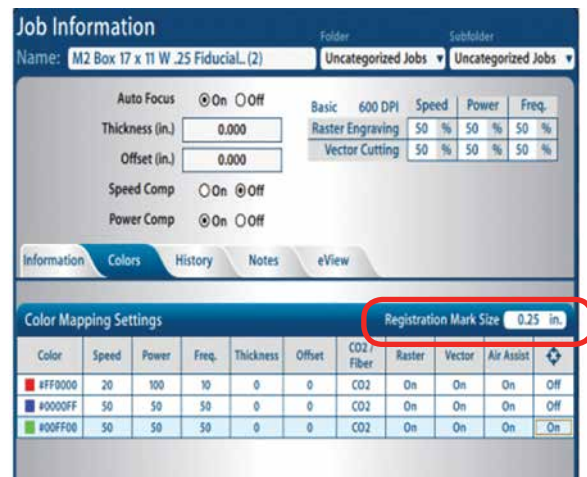



# SECTION 11: OPTIONAL FEATURES

- Click the **eView** tab.

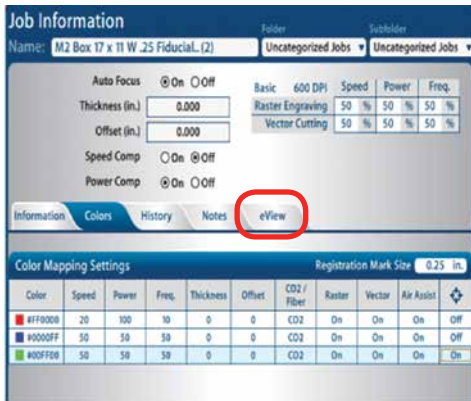

- The eView screen shows the video feed of the artwork on the laser bed.

The blue diamonds on the video feed have been identified as registration marks by the system.

You can adjust the brightness of the display to better see the table and registration marks by clicking on the Refresh key or sliding the Brightness Bar left or right.



- Designate Registration Mark 1:** In the upper right corner of the eView window you will see the Preview Window showing a line representation of the file. One of the registration marks is highlighted in pink.

Move your mouse to the corresponding registration mark in the video feed and click on the blue diamond icon that is on top of the registration mark in your artwork. Clicking the **blue icon** designates it as our first registration mark.



- After clicking on the blue icon in the video feed it will turn pink. Click the **Proceed** key (double arrow shape) in the lower right corner.

The registration icons in the Preview Window and the corresponding video feed will turn green. This means the system has successfully identified the first registration mark.



- Designate Registration Mark 2:** After clicking on Proceed, the other icon in the line representation will turn pink.

Move your mouse to the second corresponding registration mark on the video feed and click on the

# SECTION 11: OPTIONAL FEATURES

blue icon. It will turn pink. Click the **Proceed** key again in the lower right corner.



10. After clicking the second registration mark the video feed will show an overlay of vector lines to be cut. Insure the lines are in the correct location and orientation. If they are, you are ready to print to the Fusion.

Confirm and Print using the Proceed key in the lower right corner. The job will now print to the Fusion.



11. **Hunting Routine:** The laser carriage will start moving to find the first registration mark and precisely locate its exact location on the laser bed. The same process is followed to precisely locate the second mark.

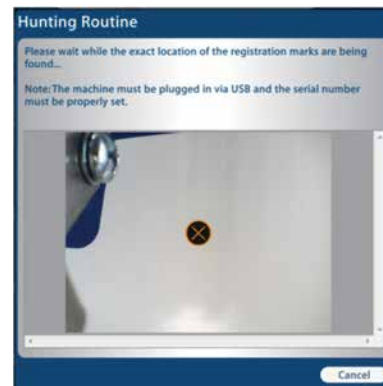

After locating the second mark, the carriage will stop moving while it is directly over the second mark. At this point, the vector files is transferred to the Fusion and the Fusion is ready to start cutting.

12. **Close the lid** of the laser. Click the **Go** key on the keypad to start the job. The laser will then move away from where it stopped over the second registration mark and start the job.

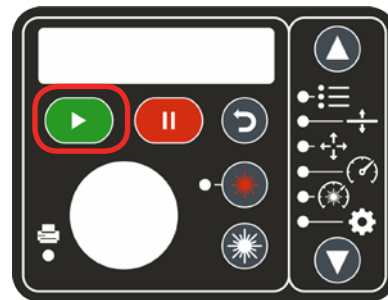

## Quick Print a Job

When you are cutting duplicate prints, you can quickly move from one piece to the next by using the Quick Print feature.

1. Quick print is determined by page size, so if you have set your page to the size of the material, place your item to be cut as close to the top left corner of the table as possible.

# SECTION 11: OPTIONAL FEATURES

2. After you have run your first laser cutting, open the door to the laser and place your next item to cut in the same direction and vicinity as the last so the registration marks are within 1.5" (38 mm) of the last position.
3. With the door to the laser closed, click on the Quick Print icon in the Job Manager. The camera system will move out to do a quick hunt for the registration marks then start the cutting process.

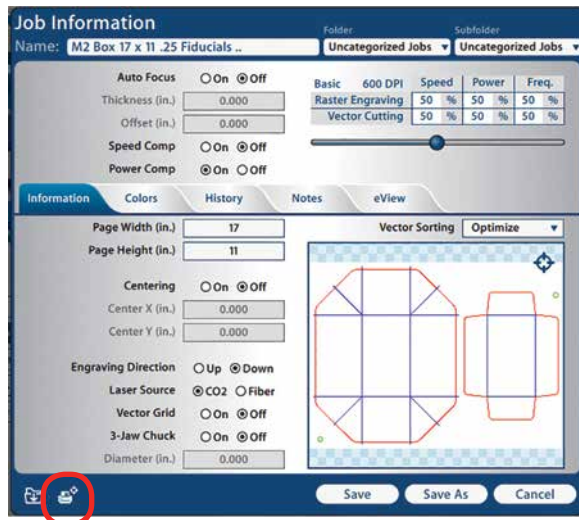

## Camera Calibration Routines

There are three camera calibration routines available to align the two overhead and one lens carriage camera. If you see severely blurry or double images from the overhead cameras, you will need to calibrate the system. Since the overhead cameras are used to approximate the location and orientation of the printed artwork, **slight imperfections in the video feed will not impact the precision of the vector cut paths.**

**All three calibration routines should be run *in the correct order* to correctly calibrate the cameras.**

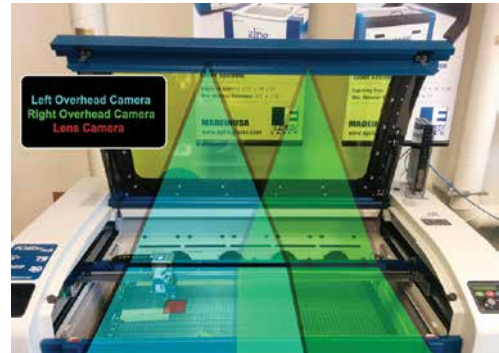

## Checking Camera Calibration

To check the overhead camera calibration, you must have set up your laser system in the Epilog Job Manager. For more details, see **“Activate a Laser” on page 36.**

1. To check the overhead camera calibration, **open the top door.** Open the Job Manager and find one of the eView Camera jobs you have sent to the laser. If you still need to setup a file, see **“Setting Up the Print File” on page 136.**
2. Click on the **eView tab**, and the screen will show the video feed from the overhead cameras. When the door cameras are properly calibrated, the image is crisp, clear and covers the entire table.
3. If there is a severe double image, then the cameras will need to be calibrated. **You will need to follow all three calibration steps that follow.**



# SECTION 11: OPTIONAL FEATURES



If you see a double image, first make sure the table is in focus. An out of focus image will cause distortions in the image.



Remember, the two overhead cameras in the door show the approximate location and orientation of your printed artwork on the laser bed. Slight imperfections in the video feed of the overhead camera will not impact the precision of the vector cut paths. If you see slight blurriness of the display, there is no need to run the calibration settings.

## 1) Overhead Camera Calibration

1. Click on the settings icon in the upper right corner of the Epilog Job Manager.



2. Click on the **Camera** tab, then **Calibrate Overhead Cameras**.

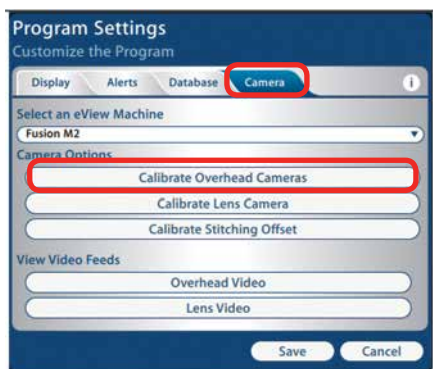

3. Select your laser from the drop-down menu, then click the **Proceed** key. The calibration routine will start immediately. The lens carriage will move across the bed left and right, from top to bottom, in order to map the entire Fusion table.

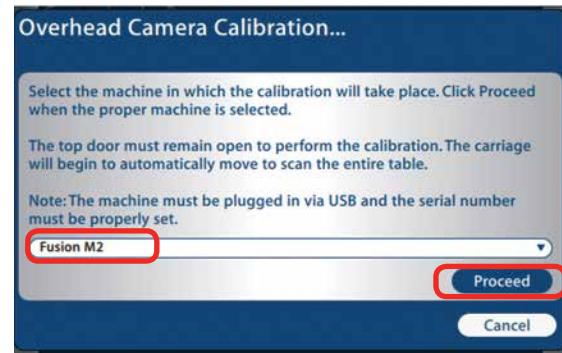

This will take approximately ten minutes but can take longer under low light conditions.

4. As the carriage moves across the table, the overhead cameras precisely map and record the exact location of the Lens Registration mark that is on top of the carriage. It then uses a complex calculation to precisely pinpoint where the carriage is located at any point above the laser bed.



5. When finished, the calibration video feed will disappear and the Calibration Complete window will appear. **Press OK**.

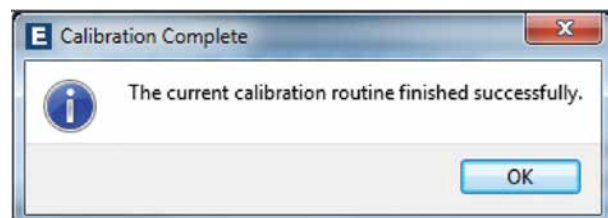

# SECTION 11: OPTIONAL FEATURES



After running the Calibrate Overhead Cameras routine, **you must run the Calibrate Lens Routine and the Calibrate Stitching Routine.** Move on to the Lens Camera Calibration.

## 2) Lens Camera Calibration

The second step requires the calibration of the camera located at the lens carriage. The lens carriage camera takes the images from the overhead camera and uses them to precisely define the location and orientation of your artwork on the laser bed.

1. In the Job Manager, click the Settings icon.



2. Click the **Camera** tab then, **Calibrate Lens Camera**.

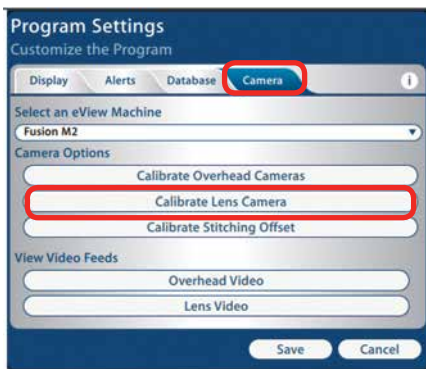

3. This process engraves five location points onto a piece of anodized aluminum. You will need a 6" x 6" (152.4 x 152.4 mm) or larger piece of anodized aluminum or other very high contrast material (such as black and white plastic) to complete this process.
4. Place the aluminum into the upper left corner of the laser bed.

5. Select your machine and click the **Proceed** key.

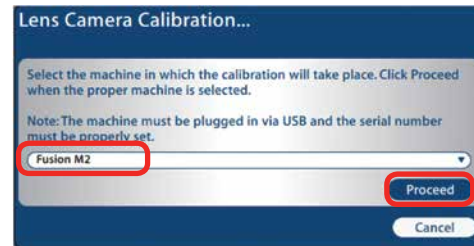

6. Clicking the Proceed key sends a job titled "**LensCamCalib**" to your laser. Close the top door and press the **Go** key on the Fusion keypad to run the job.

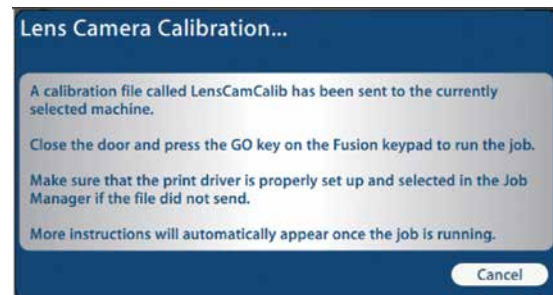

7. The job engraves five specially designed registration marks on the anodized aluminum piece.



Once the engraving is complete, open the door, but do not touch or move the engraving until all of the steps below have been completed. Press the **Proceed** key.

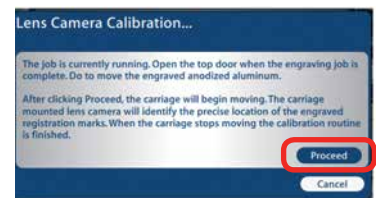
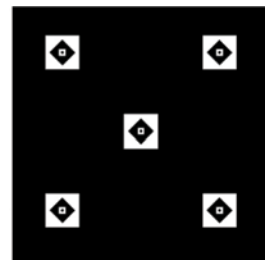

# SECTION 11: OPTIONAL FEATURES

- The system will now analyze the exact position of the registration marks by moving the carriage over the engraved piece. The system will annotate the images with cross-hairs as it calculates the precise location of the lens camera relative to the engraving.



- Once the Lens Camera Calibration routine has finished, the lens camera will be fully calibrated. Press the **OK** key and move on to the third step - calibrating the stitching offset.

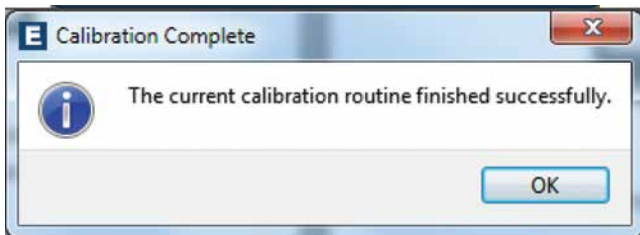

## 3) Calibrate Stitching Offset

After calibrating the overhead and lens cameras, you will need to run this routine. The calibration routine stitches the two overhead camera views together where they overlap in the middle of the table.

- Click the **Settings** icon.



- Select the **Camera** tab, then **Calibrate Stitching Offset**.



- You will need to print out the alignment form before you can proceed with this routine. Download the form at [www.epiloglaser.com/calibration](http://www.epiloglaser.com/calibration).

## SECTION 11: OPTIONAL FEATURES

Dual Source Option

- Place the arrow on the calibration printout up against the top ruler at the middle of the table. This routine identifies the size and location of the circles on the printed paper to perform the stitching calibration. You do not need to remove the vector grid to perform this routine.

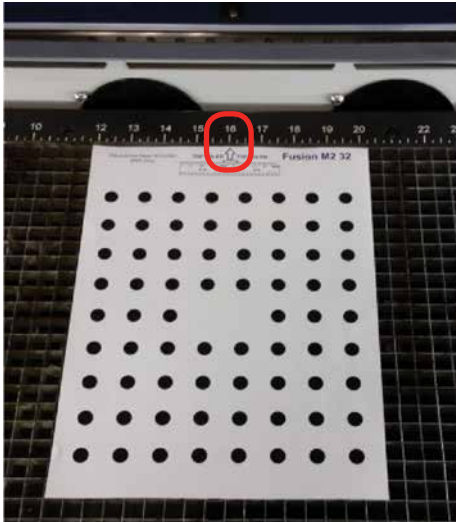

- After properly placing the calibration form, click the **Proceed** key.



- The carriage will automatically move back and the table will move to its focus position before the calibration routine begins. This routine only takes a few seconds.

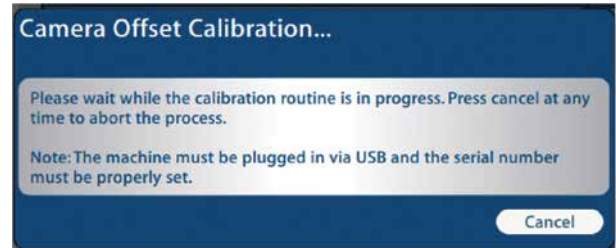

- When the stitching calibration is complete, the Finished window will pop up. Click **OK** and the calibration routine is complete. Press the Reset key on the Fusion keypad to return the carriage to its standard Home Position.

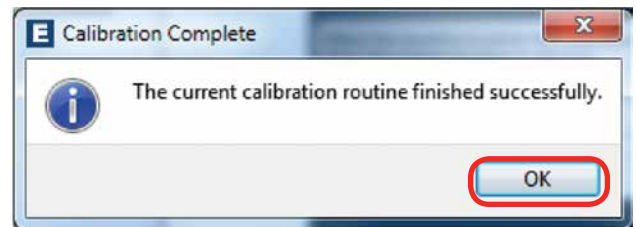

# SECTION 11: OPTIONAL FEATURES

## Dual Source Option

If you have chosen the dual source option on the Fusion M2, you get the benefit of a CO2 and fiber laser source both in one system. The operation of this system is fundamentally the same as running either the CO2 or fiber laser separately. In a typical job when you are using only the CO2 or only the fiber laser, you will set your laser source in the Default Settings section of the Epilog Dashboard Print Driver.

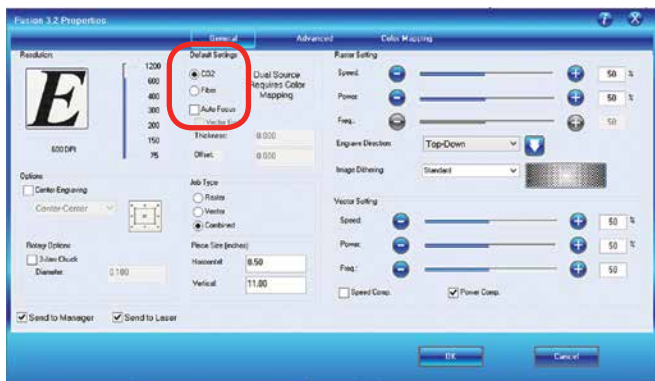

## Setting Up a Dual Source Job

If you are doing a project that requires both CO2 and Fiber laser sources in the same job, you will use Color Mapping to determine which parts of the job should be just CO2 and which should use the fiber laser source.

In this example we are engraving a bottle opener with a wood handle and metal opener. We've set up the file to use the default black settings for the CO2 wood engraving, and color mapped the red for the fiber metal etching.

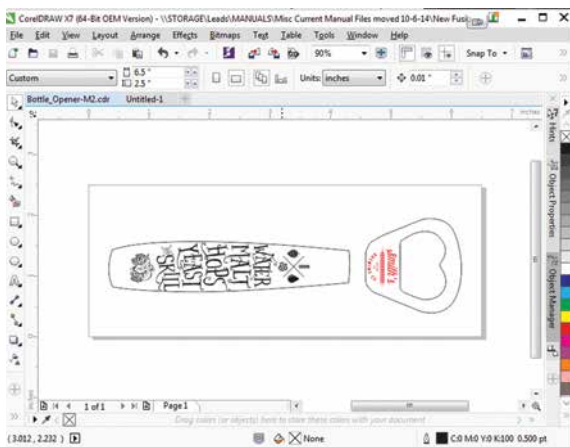

1. When your file is ready, print it to the laser. In the Laser Dashboard, set your engraving settings for the CO2 laser on the General Tab.

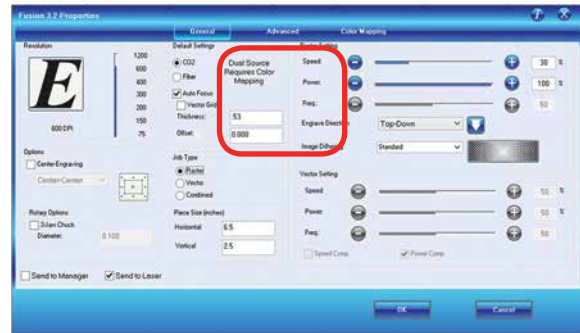

2. Set the Resolution, set the **Piece Size**, and choose **Raster** as the Job Type.
3. Under **Default Settings**, your settings will be for the non color mapped images. In this case, it is the handle image, which will be engraved in wood.
4. Set the default color laser source (CO2 in this case).
5. Turn on Auto Focus and set the thickness of the wood handle (.530" in this case).
6. Click on the **Color Mapping** tab and click the **check mark next to Color Mapping**.
7. Click on the Red color and set the speed, power, frequency, thickness and offset for the fiber graphic.
8. Next set the mode to Raster for engraving or Vector for cutting and which laser source you're using (CO2 or Fiber). For more information on using Color Mapping, see **"Color Mapping" on page 97**. Press the **right arrow** to apply your settings.





## Color Mapping Order of Operation

When printing a dual source job with Color Mapping, it's important to understand the order that the laser will follow for engraving and cutting.

1. First it will engrave any color mapped raster jobs in order from top to bottom of the color map list.
2. Next, any black raster engraving.
3. Next, color mapped vector jobs in order from top to bottom of the color map list.
4. Finally the black vector lines.

In the color map list, you can move between CO2 and fiber etching or CO2 and vector cutting and back again.

## Focusing a Dual Source Job

1. Start by restoring the zero position of the table by moving to the Focus function on the Keypad. **Double Center-click** the joystick then **tilt the Joystick to the right** to restore the table to the zero position.
2. In the Laser Dashboard, turn on Auto Focus on the General tab and set your piece thickness for the black and grayscale parts of your image.
3. In Color Mapping, set the thickness for each material you have color mapped.
4. If you are annealing a part or need to adjust the focal point into the object (such as if you are cutting acrylic), you can also set an offset for both the black portion of the job as well as any color mapped sections.

## PhotoLaser Plus

The PhotoLaser Plus software package (PLP) is an optional addition to your Epilog Laser System created by CadLink

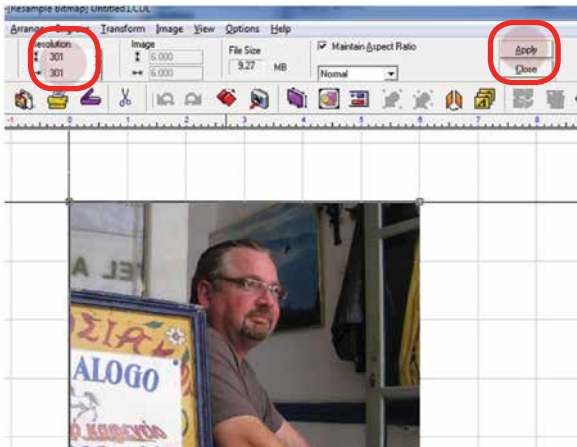

that provides an easy method of transforming photographs for your laser engraver, as well as incorporating variable badge making features. This software is not intended to replace your other graphic layout software, such as CorelDRAW or Illustrator; however it is a great complement to your other software.

Epilog only supports PhotoLaser Plus and badge layout functions in the software. The full EngraveLab software is a powerful standalone graphics package. Support for the full EngraveLab is available through CadLink.

## Setting Up the PLP Software

Epilog has teamed up with CadLink to bring you a special custom version of PhotoLaser Plus designed to only be used with an Epilog Laser system. Primary functions such as printing, Copy, Paste, etc are unavailable unless an Epilog print driver has been established as the default printer within PLP.

1. Go to **Devices and Printers** on your computer and check your print driver's name to be sure the word **Epilog** is included. If it is, you are ready to install the software.
2. If the word **Epilog** is not included in the laser's name, right click on the icon for the laser and select

### Printer Properties.

3. In the **General tab**, change the name of the printer in the first field to include the word **Epilog**.
4. Insert the CD that came with the software into the disk drive and follow the prompts for a Full Install.
5. After the install is complete, you will need to activate PLP. Open the software and click the OK key on the pop-up screen.

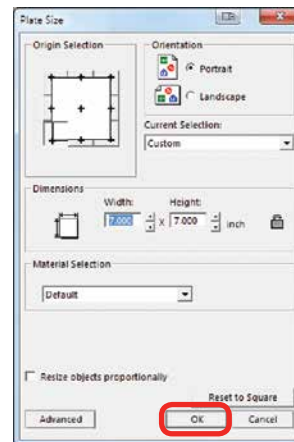

6. Place any graphic on the page. This can be an object, text, or an imported image. Print it by going to **File** then **Print**.

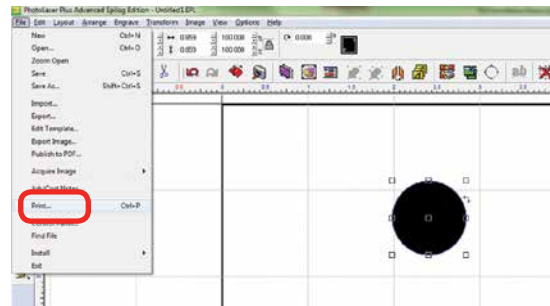

# SECTION 11: OPTIONAL FEATURES

- 7. **Select your laser in the driver list.** Make sure this has the name Epilog in the driver, or move back to step one. Next close the print window by clicking the red X.

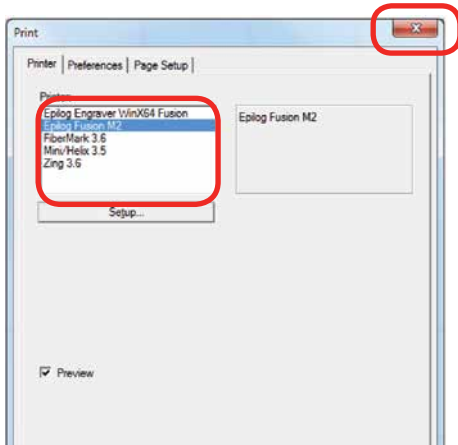

- 8. Close PLP, then reopen the software and you are ready to start using the software.

## PhotoLaser Plus Photograph Transformation

When you first open PLP, your first step is to set your plate size, which is your page size. You can set this to match the material you are engraving, or the size of the engraving table.

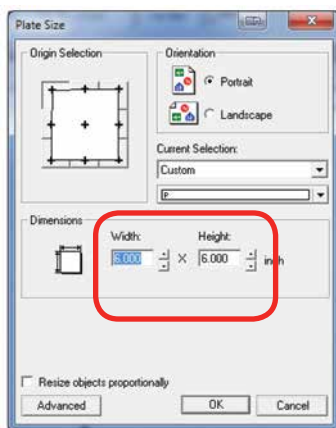

Import your photo to be transformed. Select **File** then **Import**.

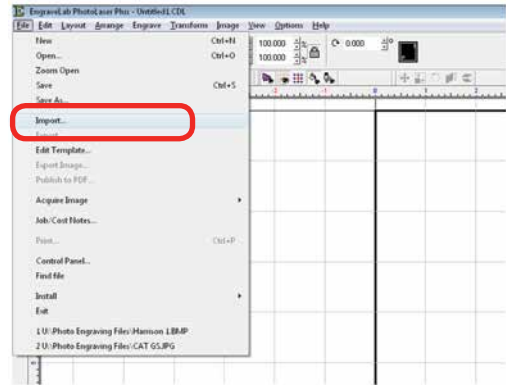

If the file looks bitmapped after the import, select **View** then **Show Reduced Bitmaps** to see the higher resolution version of the image.

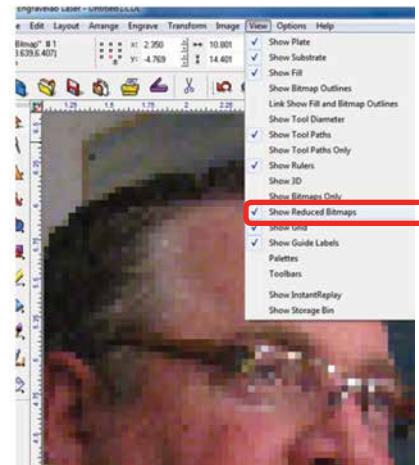

- 9. **Crop the Photo:** If you do not want to engrave the entire photo, double click on the photo to open the bitmap tools at the top of the page. Select the Rectangle or Ellipse tool to frame the area you want to crop. With the proper area framed, press the Crop key to finalize the crop.

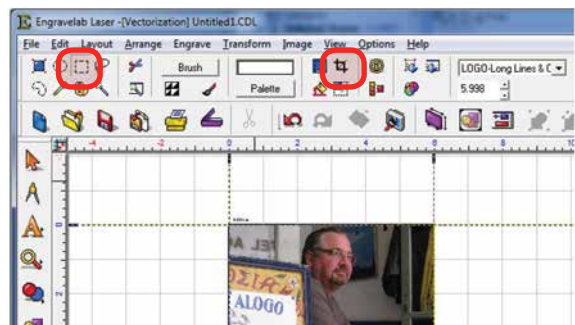

# SECTION 11: OPTIONAL FEATURES

10. **Resize the Photo:** You must now resize the photo to the size you want to engrave. With the photo selected, type in the X and Y dimensions of the photo.

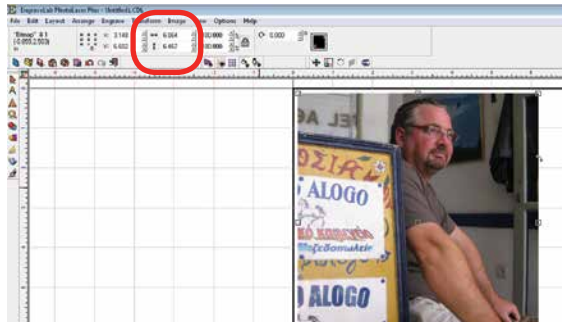

11. **Set the Resolution:** This number must match the resolution at which you will be engraving the photo. Select **Image** then **Image Size** from the menu. Type in the resolution and select **Apply**.



Make sure you have selected **Apply** or the new resolution will not be saved with the image.

12. **Transform the Photo:** With the photo resized and the resolution set, we are ready to transform the photograph. From the menu select **Transform** then **Photo Laser**. Choose **Interactive** to select the material you want to use. Choosing Automatic will apply the material settings you used on your last project.

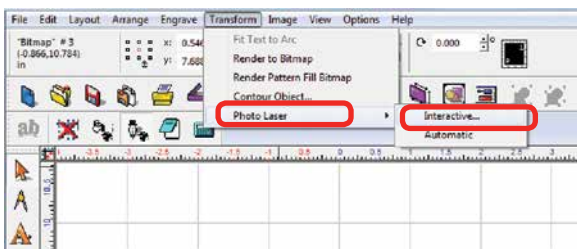

13. Select the yellow folder to open the materials folder.

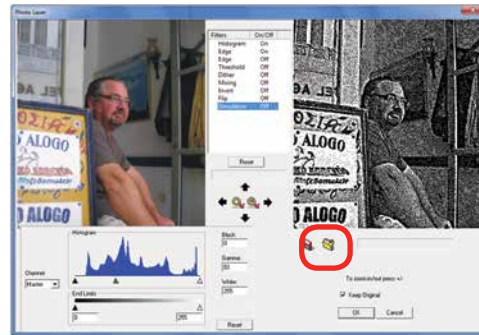

14. Choose the material you are going to engrave. If you don't see the Epilog settings, they can be downloaded from [epiloglaser.com/photolaserplus\\_instructions.htm](http://epiloglaser.com/photolaserplus_instructions.htm).

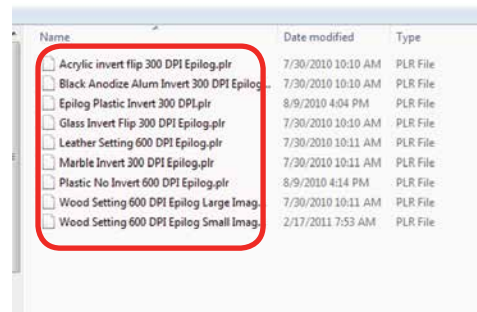

15. If you want to replace the photograph with the new 1-bit photograph, **uncheck Keep Original**, otherwise it will place the transformed image next to your original on the page. Press the **OK** key to finish.

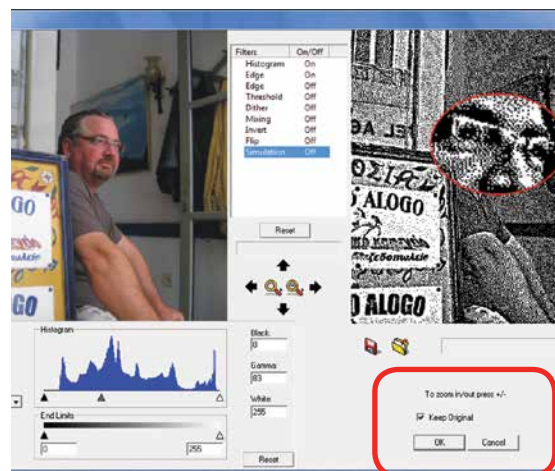

# SECTION 11: OPTIONAL FEATURES

16. You can now print the file to the laser.



Make sure you **print the image at the same resolution as you set in step 6**, or the image will not engrave correctly!

## Using CorelDRAW in Conjunction with PLP

This section takes you through the steps to prepare a file in CorelDRAW and use PLP to transform the image. This allows you to use the powerful layout features of Corel or other design software along with the photo transformation capabilities of PLP.

1. Start by setting up your file in CorelDRAW. We've designed an 8" x 10" plaque, added the text and placed a box as a placeholder for the photograph.

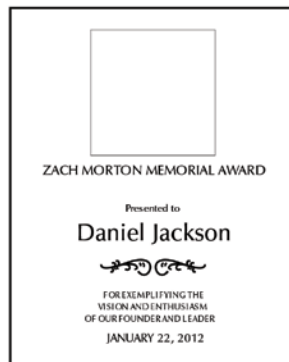

2. **Crop the Photograph:** Select the photograph, then select from the menu bar **Effects, PowerClip,** and **Place Inside Container.** Click the outline of the photo placeholder to place the photo inside the box.



3. To resize or move the photograph in the powerclip box, right click the photo and select **Edit Powerclip.** When you are finished adjusting the image, right click and select **Finish Editing this Level.**
4. **Convert to Bitmap:** With the photo selected click **Bitmaps,** then **Convert to Bitmap.**

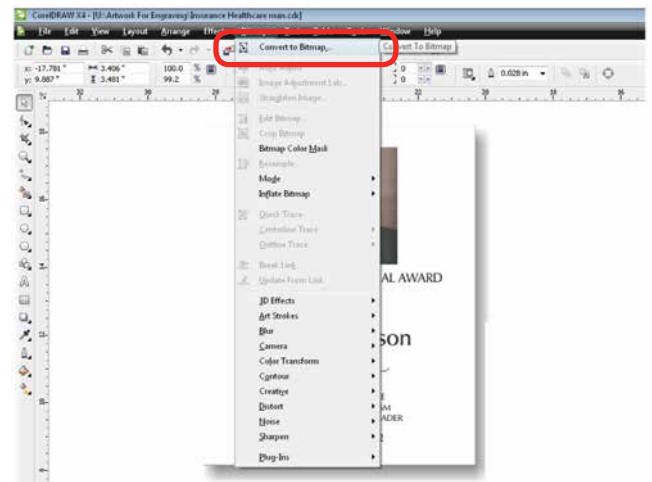

- Set the resolution to match your engraving resolution. This is usually 300 or 600 DPI. Set the color mode to either RGB, CMYK, or Grayscale (it doesn't matter which one).

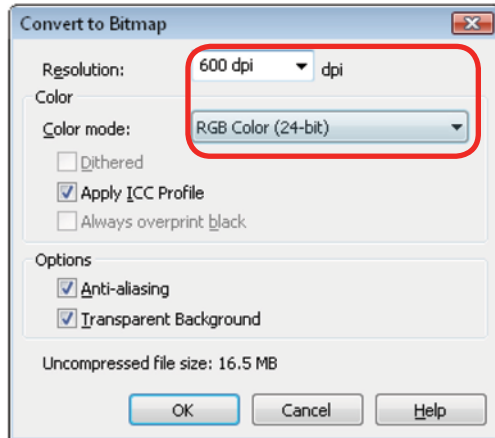

- Copy the photo in Corel by selecting **Edit**, then **Copy**.
- Open PLP and paste the image anywhere on the page by selecting **Edit**, then **Paste**.
- Transform the photo by following steps 6 through 9 in the previous section.
- After the transformed image is prepared, select **File** then **Export Image**. Export the file as a .bmp. Make note of where you saved the transformed file.
- In CorelDRAW select **File** then **Import** and select your transformed file. Place the photo in the designated space **without resizing the image**.

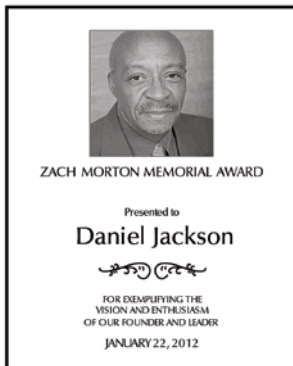

- Print the file from CorelDRAW as you normally would, using the same resolution that you selected in step 5.

## Creating Badges with Variable Names

Another feature of PhotoLaser Plus is its flexible badge layout function. We'll show you how to setup multiple items, such as badges, on one page with different names on each badge.

- Start by opening a new file and setting the plate size to the equivalent of one badge. 3" x 1" in this example.
- Setup the badge by importing any images.

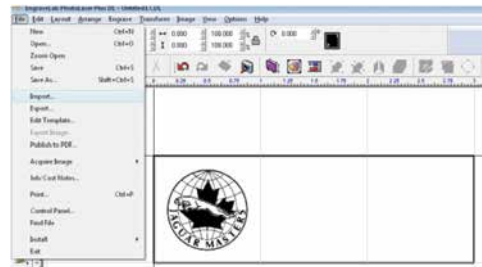

- For the variable name, go to the **Text** tool and select the second option, the **Text Compose** tool (this tool allows you to auto condense long names).

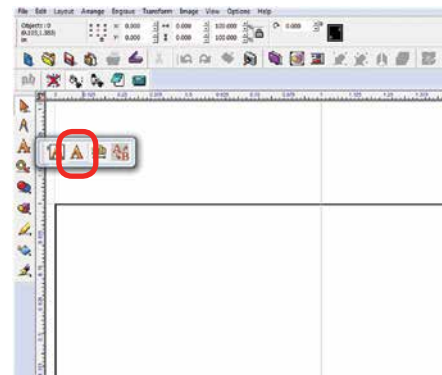

## SECTION 11: OPTIONAL FEATURES

- Click and drag a box within the badge. Size it to approximately accommodate your longest text string. Make sure it fits in the badge area.

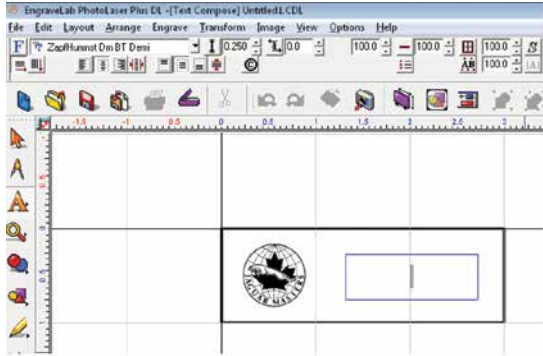

Be sure to click and drag after selecting the tool. Just clicking in the badge will invoke a different use for the tool and you will not be able to auto-condense your names.

- Type your variable in the text box. Here we used the word **Name**. Move it to its proper location on the badge.

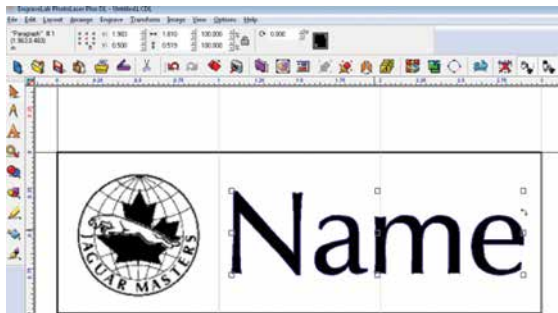

- We're now ready to create the badges. First, **select everything on the badge**. If you don't select everything, the unselected objects will not be repeated on the badges.

- Select the Badges icon in the tool bar.

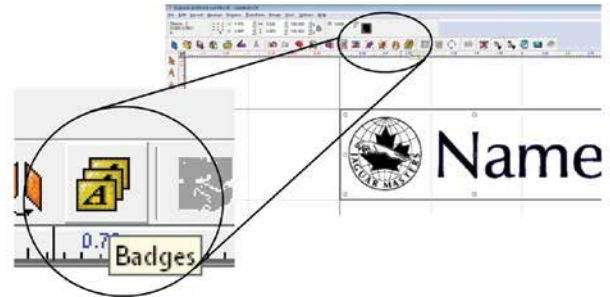

- Set the Badge Setup parameters as shown below:

- Number of Copies:** the number of badges you want to create.
- Score Lines:** Optional setting that you can use to vector cut badges if you're using material like plastic.
- Use Plate:** It's important that this be checked so that the graphic corresponds with the actual plate size you're using.
- Custom Size:** The custom plate size corresponds to the size of your material you're using to engrave the badges. We're going to laser a 12" x 12" piece of plastic, so we've set this parameter to 12" x 12".
- Compress text equally over copies:** You do not need to check this box. Long names will automatically be compressed.
- Replaceable Items/text:** Select the variable text you typed in earlier, in this case.
- Replacement Data File:** If this box is checked you can browse for a data file that has the names already entered, such as a tab delimited text file. If you do not check this box, a box will open allowing you to type in the data.

- After clicking OK, the text substitution box will open allowing you to enter or adjust the names for your badges.

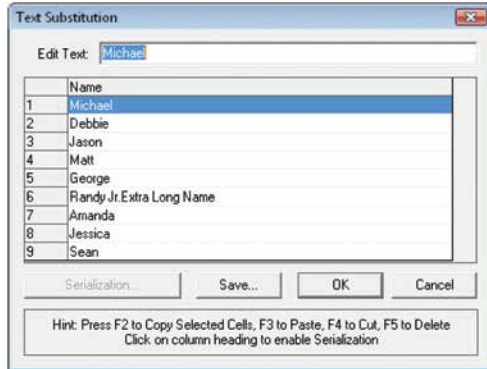

- After clicking OK, you will be taken back to your drawing page and badges will be properly laid out and populated. You can see that we have ten badges. One was left blank intentionally because we had ten badges and only nine names. You're ready to print your badges to the laser!

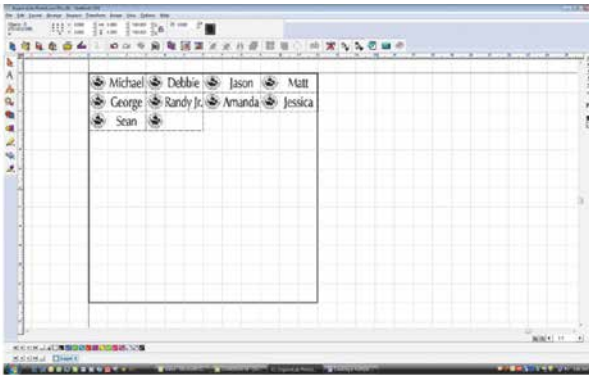

## Troubleshooting Badge Layout

**Problem:** The logo doesn't appear on the badges.

**Solution:** In step 6, you didn't select everything on the badges before clicking the Badge tool.

**Problem:** The word **Name** is repeated on all of the badges.

**Solution:** In the badge setup parameters you didn't highlight Name as the field to replace.



# SECTION 12: UPGRADING THE OPERATIONAL FIRMWARE

How to Upgrade Your Firmware

## How to Upgrade Your Firmware

Your laser system is capable of having its operational firmware upgraded. The firmware is the command software in your laser system that controls how your laser system operates (think of firmware as the “brains” of your system). A firmware upgrade reprograms your laser system to take advantage of new capabilities or enhancements to the system.

To accomplish the reprogramming, you just print a special file to your laser system. The process is explained below.

### Upgrading your laser is a two-step process:

1. Download the new firmware to your computer and extract (also known as Unzipping or decompressing) it.
2. Transfer the new firmware from your computer to your laser.

## Installing New Firmware onto Your Computer

Firmware upgrades are available at any time by downloading the firmware file from [www.epiloglaser.com](http://www.epiloglaser.com) under the **Support, Driver and Firmware Downloads**. You can also join our **Driver Notification mailing list** to be automatically notified when new versions of firmware or the driver become available). The firmware version that your system is currently running is displayed on the LCD panel when you first power up your laser system – it will read Version 1\_0\_X\_X.

**Downloading:** From the Epilog web site download the new firmware and save. Normally, the default Save location is onto your Download folder. Once downloaded, you can use a thumb drive, flash drive or other portable media to move the file from one computer to another if you need to.

When you download the firmware it comes as a compressed file in the following format: fibermark\_1\_0\_X\_X.exe. The

X's designate the actual version of the firmware. Once this file is on the computer that is attached to your laser you will need to extract (Unzip or decompress) the file. When you extract the file you will need to pay attention to the folder it is extracted:

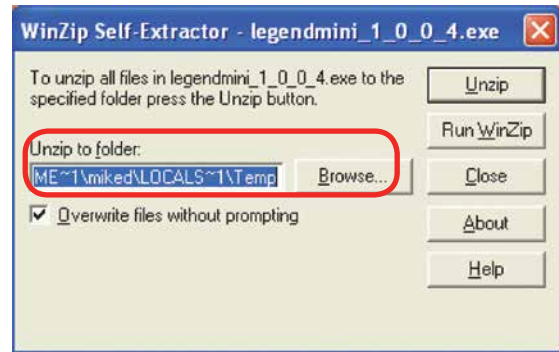

After extraction, the following message appears. Click the OK key.

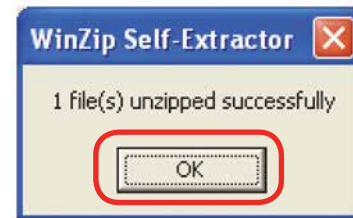

Once the file is extracted it changes from an .exe format to a .hex format that will be named fibermark1\_0\_X\_X.hex, (again, the actual number will change depending on revision level). It is the .hex format file that you will use to upgrade your laser.



**Important!** Keep track of the folder where you saved the extracted .hex file. You will need to access this file again in the next step.

# SECTION 12: UPGRADING THE OPERATIONAL FIRMWARE

How to Upgrade Your Firmware

## Transferring New Firmware from Your Computer to Your Laser

Use the following procedure to transfer the hex file to the laser:

Create a simple drawing in your graphics package. For this example, we've typed in the text **Firmware Upgrade**.

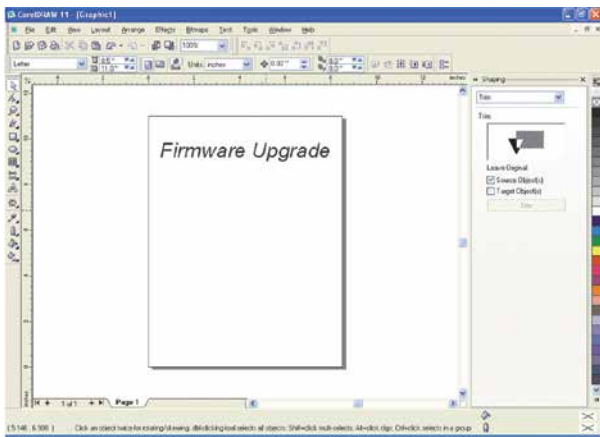

The next step is to **Print**, select the **Laser Dashboard**, and click on **Properties**.

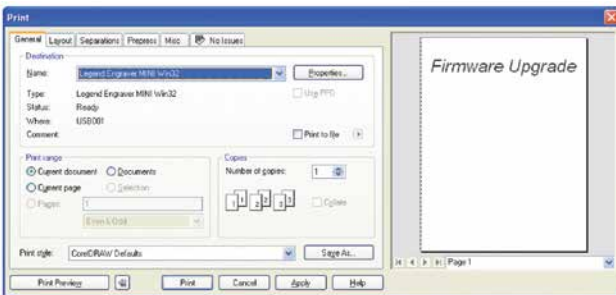

Go to the **Advanced** tab, check the **Update Firmware** box and then click on the **Load** key.

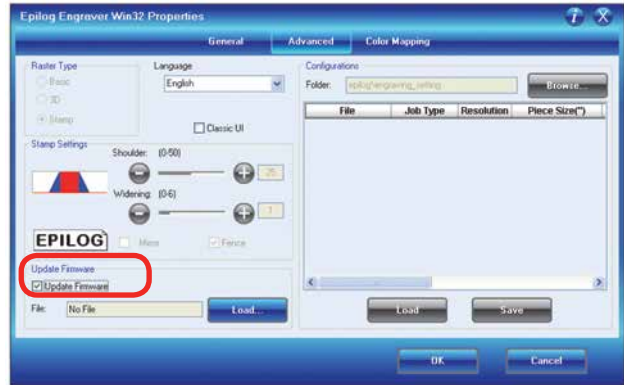

Go to the folder that contains the extracted file, select the **.hex** file and click on **Open**:

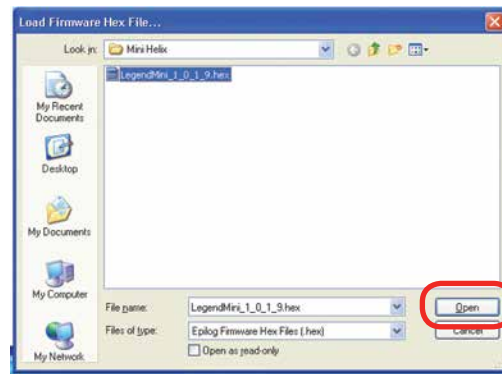

The **.hex** will show in the Update Firmware File box. Click **OK**.



## SECTION 12: UPGRADING THE OPERATIONAL FIRMWARE

How to Upgrade Your Firmware

Click **Print**.

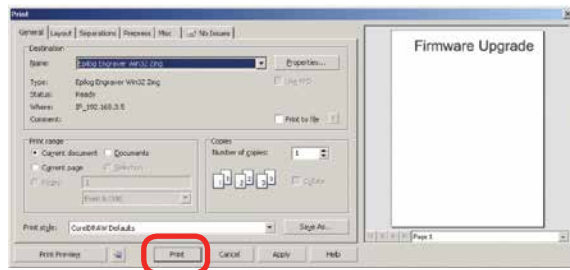

At this point, the .hex file will begin transferring to your laser. The laser knows that it is being upgraded and the graphic that you created will not print, nor will it show up as a Job. Instead, the cursor keys will light up. When the upgrade is complete, the display will read **Reboot!**



The programming process takes a few minutes to complete. **Do not disturb the laser during the upgrade process!**

After you have rebooted your laser, the process is complete and you will see the new version number of firmware on your LCD as the laser powers up.

Depending on the type of upgrade you may be requested to reboot more than once.

Close your design page and you are ready for your next job!



# SECTION 13: PRINTING FROM AUTOCAD

How to Print from AutoCAD to the Laser

## How to Print from AutoCAD to the Laser

AutoCAD is a very powerful software tool that is often used in conjunction with the laser for cutting applications. Like any tool, understanding how it works and its limitations are helpful in getting the most out of it. Below are general instructions for printing from AutoCAD. AutoCAD versions 14 to the present are mostly compatible with Epilog systems. Each version of AutoCAD uses slightly different printing conventions that may or may not affect the way you print from AutoCAD and each different version may produce different output from the laser.

### Printing/Plotting

Sending jobs from AutoCAD is heavily dependent on the print settings in the AutoCAD Print/Plot window. Since there are so many different settings that AutoCAD requires, it is important that you double-check all of the settings that are critical to success. Previewing your image before sending it to the laser is very helpful in preventing print problems.

AutoCAD is capable of producing extremely complicated drawings with many layers, colors, etc. Since there is no limit to the level of complexity that an AutoCAD drawing can achieve, users should keep in mind that the laser is a 2D cutting machine that usually cuts a single piece of material in any given job. While your laser system is capable of handling complex drawings, users may find that eliminating extraneous detail before “Printing/Plotting” may make their laser equipment more productive.

### Color Mapping

Creating objects of different colors in AutoCAD allows the user to take advantage of the Vector Color Mapping capabilities of the Epilog Dashboard print driver. Color mapping assigns different Speed and Power settings to an object based on its color allowing you to both cut and mark in a single setup. For a detailed description of how

Color Mapping works, refer to “**Color Mapping**” on page 97.

### Model Space, Paper Space, and Precise Location

AutoCAD was designed to print to paper plotters and some of the assumptions (especially Scaling and Margins) that AutoCAD makes when printing can cause frustration for laser users that are used to being able to send a job to the laser and have its precise location be very predictable. Printing from either Paper Space or Model Space will work. Be aware that the scaling and margin assumptions made by AutoCAD can affect both the size and location of the work.

### Helpful Hints

When printing from AutoCAD **you need to set up your AutoCAD page so that it is square**. This prevents the objects from rotating 90 degrees when you print them. The page in the example below is set to 24” x 24” (610 x 610 mm).

Place all of your objects in the upper portion of the AutoCAD page (see illustration below). If you are printing to a bed size of 24” x 12” (610 x 305 mm) and you have a 24” x 24” (610 x 610) page, the objects in the lower 12” (305 mm) will not be processed.

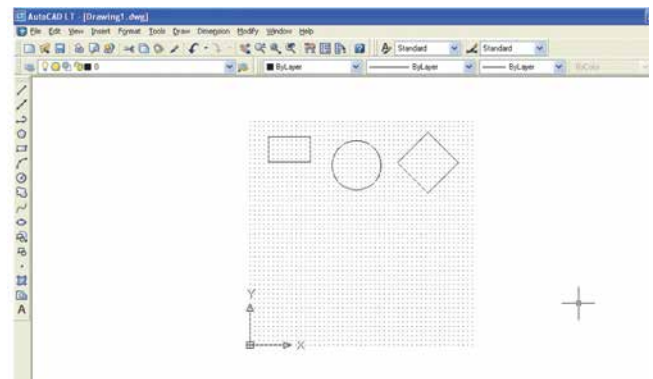

# SECTION 13: PRINTING FROM AUTOCAD

How to Print from AutoCAD to the Laser



Set the Piece Size to match your AutoCAD page size. Setting your AutoCAD page and the Dashboard print driver settings to a square configuration (36" x 36", for instance) is necessary to overcome AutoCAD's tendency to rotate your artwork 90 degrees.

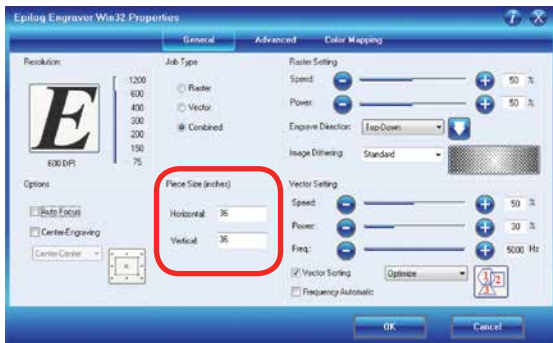

In the AutoCAD print window, set the pen colors that you are using to .001" (.0254 mm).

The AutoCAD default for all pens is .010 and a line weight this large disables vector cutting. If the line weight is not changed to .001 inch, vector cutting will not be possible.

When the laser receives a job where the line weights are

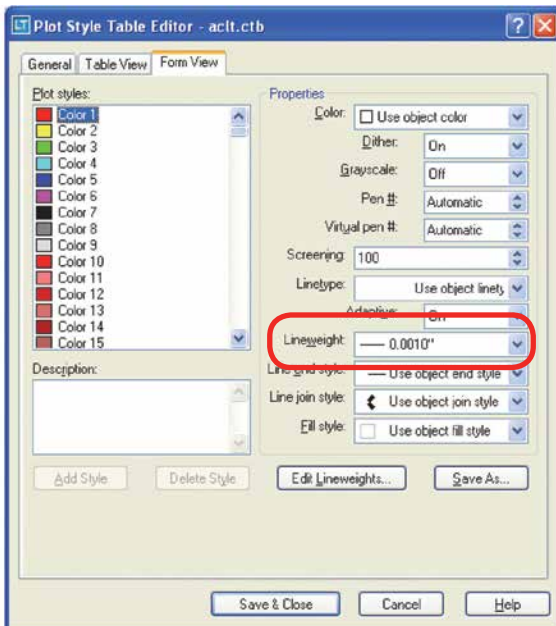

to run the job.

Other useful settings in the AutoCAD print window are:

- Set the page orientation to Portrait.
- Set Plot area to Limits.
- Scale set to 1:1.
- Pen Sizes .001 inch (0.0254 mm).

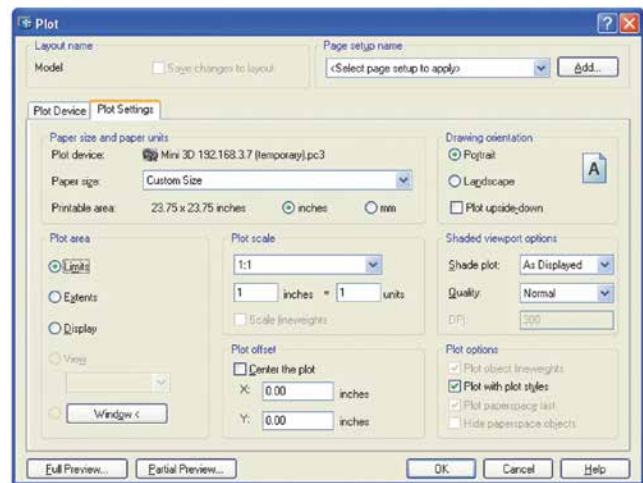

too large, the laser system will just beep when you attempt

# SECTION 14: MATERIAL ENGRAVING TECHNIQUES

## CO2 Laser Materials/Techniques

Your Epilog Laser system is very versatile. It can mark and cut many different materials. Following is information regarding some of the materials the laser will mark and cut. Check the Epilog website ([www.epiloglaser.com](http://www.epiloglaser.com)) periodically for new laser applications, tips and techniques to use with your laser. For specific information regarding materials not mentioned below, please contact your local Epilog representative.

### 3D Engraving

Earlier in the manual we discussed dot patterns and how those patterns are used to create raster images. 3D mode looks at the dots and the dot patterns in a very different way than basic raster engraving mode, especially when using grayscale images.

In 3D mode, instead of looking at the dots and determining where to fire the laser based on the dot spacing, we look at the dots and determine how much laser power (wattage) to apply to each dot. In basic raster engraving mode, every dot is fired at the same laser output. In 3D mode we have the ability to adjust the laser output for every dot.

An additional aspect of 3D mode is that, unlike basic mode, the laser fires continuously between most dots – even if it is engraving from a 10% fill pattern to a 30% fill pattern. This is by design so there is a gradual change in the depth of engraving when the artwork transitions from one shade of gray to another. The only time that this is not true is when the artwork changes from 100% black to 100% white (or visa versa). Because we adjust the way the laser fires in 3D mode we also have to adjust the artwork that is used to create good 3D images, and this is where 3D engraving can get difficult.

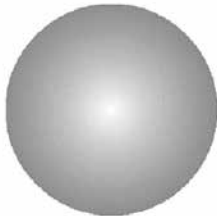

Since we're going to vary the laser power output for every dot, we want artwork that will produce more than one level of gray. We want artwork that gradually blends from one shade of gray to another. You need an object that looks something like this circle to create a 3D image.

Engraving this circle in 3D mode will create a dome with center being the high point (because it's a light shade of gray) and the outside edge being deep (because it's a darker shade of gray).

This explanation describes the most basic functions of 3D engraving and some of the theory behind



In this sample, the black background would be engraved away. Using this technique, the leaf stands up away from the background, with the edges of the leaf being the highest points and the stems being engraved the deepest.



This image would engrave deepest around the edges of the leaf and less deep in the body.

## SECTION 14: MATERIAL ENGRAVING TECHNIQUES

it. What it doesn't describe is the difficulty that most users will have in creating acceptable 3D artwork. Creating a 3D image that will look good after engraving can be very difficult to achieve because most software packages do not provide the necessary tools to take complex objects and blend them in more than one direction from dark to light (or, visa versa). There are some 3D graphics software packages available that will create 3D images, but they generally cost between \$3,500 and \$10,000 USD. Ask your Epilog representative if you would like more information on these software packages.

### Acrylic



**Fire Warning:** Your laser system uses a high-intensity beam of light that can generate extremely high temperatures when it comes into contact with the material being engraved, marked or cut. Some materials are extremely flammable and can easily ignite and burst into open flame setting the machine afire. This open flame is very dangerous and has the potential to destroy not only the machine, but the building in which it is housed.

Experience shows that vector cutting with the laser has the most potential to create an open flame. Many materials are susceptible to igniting, but acrylic -in all its different forms - has been shown to be especially flammable when cut with the laser.

For more information on fire hazards associated with lasers, please **read the full “Fire Warning” on page 1 of the manual.**

### Choosing the Right Type of Acrylic

There are two types of acrylics and each is suitable for different applications. **Cast acrylic** sheets and objects are made from a liquid acrylic that is poured into molds that can be set into various shapes and sizes. This is the type of acrylic used for the awards you see on the market. Cast acrylic is ideal for engraving because it turns a frosty white color when engraved. While it can be cut with a laser, it will not give you flame-polished edges.

The second type of acrylic that you will use with your laser is formed into sheets by a machine and is called **extruded acrylic**. It is formed through a higher-volume manufacturing technique, so it is typically less expensive than cast, and it reacts very differently with the laser. Extruded acrylic will cut cleanly and smoothly and will have a flame-polished edge when laser cut. But when it is engraved, instead of a frosted look you will have a clear engraving.

### Acrylic Engraving Techniques

- Most acrylic is engraved on the backside to produce a look-through effect from the front surface.
- Remove the protective adhesive paper from the back of the acrylic before engraving. Leave the front protective cover layer on to prevent scratching while handling the acrylic. Since you are engraving the backside of the acrylic, you will need to reverse or mirror your artwork before sending the job to the laser.



## SECTION 14: MATERIAL ENGRAVING TECHNIQUES

CO2 Laser Materials/Techniques

- Engrave the acrylic at a high speed and low power. A small amount of power is all it takes to mark acrylic and high power levels tend to distort the acrylic when engraving.
- There are a large number of acrylic products that are painted on one side to add color. You can engrave directly through the paint into the acrylic for a very nice presentation effect. Leave the speed the same as if you are engraving clear acrylic, and increase the power about 10% to get completely through the paint. Applying too much power to the paint will melt it and cause distortion.

### Acrylic Cutting Techniques

Acrylic is one of the most popular cutting materials available. It comes in a variety of colors and thickness. Laser cutting produces very nice edge quality without the need for polishing or secondary clean up.

- Use the Vector Cutting Table or Pin Table to elevate the acrylic before cutting. Air Assist will greatly reduce flaming when cutting acrylic and should always be used for this material. Information on accessing the Vector Cutting Table is included in **“Vector Cutting Table/Vacuum Hold-Down Table” on page 113.**
- To find the perfect settings for cutting acrylic, you will need to experiment. Test different speed and power settings by cutting a small shape from a scrap piece of acrylic you will not be using.
- Cutting acrylic is usually best achieved with relatively slow speed and high power. This combination allows the laser beam to melt the edges of the acrylic and produce an almost flame-polished edge.
- Acrylics generally require only a single pass to cut, but thicker acrylics may need two passes. Some users find that spritzing the protective adhesive paper with water produces a better edge when laser cut.
- Setting the focus distance at the center of your acrylic sheet will produce better edge quality than focusing on top of the acrylic sheet.



**Warning!** Never leave your laser unattended when vector cutting any material! Acrylic is very flammable. **Read the full “Fire Warning” on page 1 of the manual.**

### Anodized Aluminum

Anodized aluminum is a coated aluminum that comes in a variety of colors and can usually be easily engraved with a CO2 laser.

- Black anodized aluminum is great to work with because it turns white when engraved and provides the best contrast of all of the colors of anodized aluminum.

## SECTION 14: MATERIAL ENGRAVING TECHNIQUES

- Some colors of anodized – red for instance – will not turn completely white when laser engraved. Red anodized will produce a light pink color. Performing a second pass can result in some improvement, but usually a slight shadow of color will remain.
- Engrave anodized aluminum at high speeds and low powers for crisp, clean results. Too much power applied to the anodized coating will distort the engraving and tends to over-burn the image.
-  **Warning!** Metals are reflective. Using full power with them can potentially cause damage to the machine.

### Brass - Painted

Since the frequency of the CO2 laser is not compatible with bare metals, uncoated brass cannot be laser engraved. For bare-metal marking you will want to use an Epilog FiberMark system. In order to engrave brass with a CO2 laser you need to use brass that has some sort of coating – typically paint. The laser removes the paint and exposes the brass substrate.

There are two basic types of engraveable brass available, but they are not all compatible with the laser.

- By far, the most popular laser brass is actually brass-coated steel. First, a steel substrate is coated with a thin layer of brass. Next, the brass is polished to a reflective finish and a coat of lacquer is applied to the brass – Victory’s LaserBrite™ product has a lacquer finish. Finally, a paint coating is applied on top of the lacquer for the finished product. When laser engraving brass-coated steel, you are removing only the paint and exposing the polished brass coating that is protected by the lacquer. The lacquer prevents the brass from oxidizing and the bright reflective surface will stay bright for years.
- Some manufacturers also sell painted brass that is solid brass, not brass-coated steel. If the brass is polished before the paint is applied you will have a bright, reflective engraved surface. If the brass is not polished, the result will be a dull, tarnished brass that will require a secondary polishing process after laser engraving. This is time consuming and most engravers do not want to spend the time and effort necessary to turn this into an acceptable product.
- **Note:** Always ask before lasering painted brass if you don’t know the substrate! If you are unsure if your piece is brass-coated steel or genuine brass, you can test the material with a magnet. A magnet will stick readily to brass-coated steel, but since solid brass is not magnetic, a magnet will not adhere to solid brass.

### Painted Brass Engraving Techniques

- Engrave painted brass with a high speed and low power setting. It takes very little power to remove the paint coating and too much power will melt the paint and distort the image. If your mark on brass is turning out “fat” or has a balloon appearance to it, you are probably using too much power. Reducing the power will bring back the nice sharp images that are normally produced with painted brass.

## SECTION 14: MATERIAL ENGRAVING TECHNIQUES

- **Note:** Use caution when trying to engrave brass coated pens. Many pens have a very hard epoxy paint that is completely unacceptable for CO2 laser engraving. You should only use pens that you have experimented with or that are specifically designed for CO2 laser engraving. Be aware that there are many pens that can be laser engraved with a fiber laser but these pens are usually not compatible with the CO2 laser that you are using.
- Some paints are “almost” CO2 laser engraveable. If you engrave through the paint and there is a slight shadow remaining, try to clean the engraved area with alcohol or lacquer thinner. Depending on the paint, there is a good chance that the shadow will disappear and an excellent engraving result achieved.
- Use caution when trying to engrave blue painted brass. Blue paints contain very aggressive pigments that penetrate the metal surface and it can be extremely difficult to remove all of the blue color, but again, try alcohol or lacquer thinner to remove the shadow.

### Glass

When a laser strikes glass it fractures the surface but it will not engrave deeply or remove material. The fracturing of the glass surface will produce a frosted appearance but can cause roughness and chipping depending on the type of glass being engraved. While the frosted appearance is desired, the roughness and chipping are not. Below we explain how to eliminate the roughness and produce a very smooth frosted finish.

The composition and quality of glass varies widely and you cannot always predict the effect that you will achieve. It is always best to experiment with an unfamiliar glass source. Generally speaking, flat glass tends to have a very consistent hardness throughout, and the engraved areas do not tend to have lighter and darker areas. Bottles on the other hand, tend to have soft and hard spots that will cause the engraved area to appear lightly frosted in one area and heavily frosted in another. Engraving at medium speed and high power will somewhat compensate for this, as will two or more engraving passes.

While the laser beam itself is very hot, the heat does not build up easily and it should not prevent you from engraving onto full bottles of wine, champagne or other filled glass bottles. Laser engraving filled bottles is a very popular method of creating custom presentations for special occasions. The laser will not damage the liquid inside the bottle, and as long as you are not completely engraving away a large section of bottle you have very little chance of breaking the bottle.

### Glass Engraving Techniques

To produce a smooth frosted finish, here are some tips:

- **300 DPI:** Using a lower resolution, around 300 DPI, produces a better result on glass as you separate the dots you are engraving.
- **80% Grayscale:** Change the black in your graphic to 80% black to improve the engraving quality.
- **Jarvis Dithering:** Running with a Jarvis dithering pattern in the driver (you’ll find this under the raster speed and power settings) will also help provide a smoother finish.

## SECTION 14: MATERIAL ENGRAVING TECHNIQUES

- **Masking:** Some people find that applying a thin, wet sheet of newspaper or paper towel a little larger than the engraving area also helps with heat dissipation and improves the engraving. Just be sure that there are no wrinkles in the paper after it is applied.
- **Dish Soap:** Using your finger or a paper towel, apply a thin coat of liquid dish soap – any kind will do – over the area to be engraved. This will dissipate the heat when engraving.
- **Polish:** If there are small shards of glass, you can polish the area with a ScotchBrite pad or something similar.

**Note:** You need to be especially careful when laser engraving leaded crystal. The lead in the crystal expands at a different rate than the crystal does and this can cause cracking and breakage of the crystal. Using a lower power setting can help this problem, but we always recommend having a spare in case of breakage.

### Combining Laser Engraving with Sandblasting

Combining the best of both processes, you can use your laser to engrave the artwork then use sandblasting to provide a deep etch into glass. Using the laser to create the artwork mask is an ideal process for one-of-a-kind custom pieces as well as large production runs. This eliminates the photo process usually associated with sandblast mask.

1. Apply an adhesive-backed mask material to the glass that you are going to engrave.
2. Laser completely through the mask and into the glass.
3. Remove the glass from the engraver and sandblast to the desired depth.
4. You now have a sandblasted glass presentation with the detail of laser engraving!

### Notary Seals: Delrin

Notary seals can be easily manufactured using 1/16-inch (1.5 mm) thick delrin plastic. A seal consists of two pieces - a male die and a female die, both shown below. The male die consists of white lettering on a black background and the female die is an inverted and mirrored image of the male. Inverting and mirroring are easily accomplished in most graphics software packages. Simply duplicate the male die, invert the black and white colors, and then mirror the image.



Male Artwork



Female Artwork

## SECTION 14: MATERIAL ENGRAVING TECHNIQUES

The male image should be produced without the use of outlines around the text or graphics. Add a .007 to .010 inch (0.178 mm to 0.254 mm) outline to the text and graphics of the female die. This outline creates a large enough void between the male and female dies to emboss paper without tearing.

Apply a .001 outline around the seal to define the outside edge of the seal. Use the Combined Mode to first raster engrave the seal and then vector cut out the seal.

### Plastic Engraving/Cutting

There are two types of available engraving plastics: rotary plastics and laserable plastics. Rotary plastics are designed for rotary engraving systems that use a mechanical spinning bit to remove material. Therefore, the depth of the top layer or “cap sheet” was designed to make it easy to rotary engrave. Cap sheet thickness was approximately .010 inches (0.254 mm) thick and laser engraving was nearly impossible because by the time you applied enough power to get through the cap sheet the laser melted and deformed the plastic.

Laserable plastics have been developed with a thinner cap sheet that is .002” to .003” (0.051 mm to 0.076 mm) thick, providing much better engraving and cutting characteristics. These plastics are commonly referred to as micro laminates; micro-surfaced, or simply laser engraveable plastics. These plastics are generally very easy to engrave with a laser since they all have similar characteristics.

Because there is such a broad range of plastics it is necessary to experiment to determine if a particular type of plastic is laser compatible. Different color plastics, even if they are from the same manufacturer, will have unique speed and power settings. Use the guidelines in this manual as a starting point when determining the correct speed and power settings. If you do not get acceptable initial results with the recommended speed and power settings, start experimenting by first changing only the power setting. If adjusting the power setting does not work, start over and adjust only the speed setting. Once you have acceptable results, record those settings for that particular plastic so that you do not have to repeat the experimentation process.

### Plastic Engraving Techniques

- Always remove the clear protective cover layer before engraving.
- Once you have the correct speed and power settings you can improve your engraving results even more by taking the focus lens out of focus (lower the table) by about 1/16 (1.5 mm) of an inch. This technique enlarges the focus beam a little bit and provides more beam overlap on each pass of the laser. The greater overlap produces a smoother engraved surface on the plastic and eliminates the grooves that you sometimes see when engraving plastic.
- With some plastics it is best to engrave using two passes. The first pass cuts through the cap layer and the second pass cleans away the residue that some plastics leave behind.

## SECTION 14: MATERIAL ENGRAVING TECHNIQUES

- Another technique that can be useful is to mask the plastic before engraving with transfer or masking tape. This will prevent a buildup of residue on the plastic surface. Misting the transfer tape with water will reduce heat buildup and melting on sensitive plastics.

### Plastic Vector Cutting Techniques

- Use a Vector Cutting Table to elevate the plastic before cutting. Air Assist will greatly reduce flaming when cutting plastic.
- Vectoring plastics is similar to vectoring other materials. First, experiment to determine if the plastic can be cut with the laser. Plastics that are up to 1/16 inch thick can usually be cut in a single pass. Thicker plastics may need two passes.
- As with engraving, it is sometimes necessary to mask and dampen the plastic before cutting. Even masking and wetting both front and backsides of the plastic is desirable on sensitive plastics that have very low melting points.



**WARNING!** Never leave your laser unattended when vector cutting plastics! Plastic can be very flammable. **Read the full “Fire Warning” on page 1 of the manual.**



**WARNING!** Do not engrave PVC (Polyvinyl Chloride). PVC will destroy the optics and mechanics of your Epilog system. Cutting or engraving PVC will void your warranty. The only way to find out if there is PVC in your plastic is to check the manufacturer’s Material Safety Data Sheet (MSDS).

### Rubber Stamps

The Dashboard includes settings for producing rubber stamps. Unique stamp attributes are controlled from the driver including, Speed and Power settings, Shoulders, Widening, and more.

### Creating Your Layout for Stamps

Set up your artwork in Corel so that your computer image looks like the image that you want to stamp. Areas to be stamped (the raised areas on the stamp) should be black, with the area to be removed white. You can either invert (mirror) your graphic in the graphic software you are using or select “Mirror” in the print driver.

The artwork for a stamp file needs to be set up so that the background of the image will be engraved away and the words and letters remain standing. The two ways of setting up a stamp file are determined by the method you use to define the area that is to be engraved away.

## SECTION 14: MATERIAL ENGRAVING TECHNIQUES

**Fence Method:** This technique uses a closed outline to define the area to be engraved away. This image shows the stair-step outline of a Fence enclosing the logo to be stamped. The laser will engrave away only the background area outlined by the Fence, leaving the logo standing.

This method is useful because it allows you to be very precise about how much background you are going to engrave away, saving time and material. The fence must be .001" (.025 mm) thick and can be any closed polygon or ellipse. You can even place several stamps within one fence.

**Page Size Method:** Some software programs do not recognize closed outlines. For these programs (Illustrator and some third party custom stamp packages) you need to use the page size to define the area that will be engraved away. Set the page size to the size of the stamp. The laser will engrave away the entire background of the page, leaving the logo standing.

**Cutting Out the Stamp:** If you are using the Fence Method, any line within the area with a line weight of .001" to .007" (.025 - .175 mm) will be vector cut when sent to the laser.

**Creating a Perforated Cut:** To create a perforated cut around the stamp that will allow the stamp to be pulled away from the rubber, in the print driver set the vector frequency below 5. This keeps the stamp attached to the rubber sheet and makes cleaning easy while allowing the user to easily remove the stamp from the sheet.



# SECTION 14: MATERIAL ENGRAVING TECHNIQUES

## Examples of stamp layouts using Fence Method:

**Example 1:** Single stamp (will not be cut out):

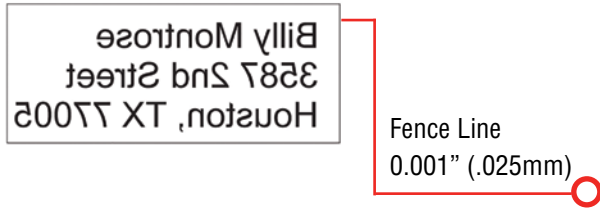

**Example 2:** Single circular stamp to be cut out:



**Example 3:** Multiple stamps to be cut:



**Example 4: Incorrect!** The file contains multiple fence lines. If creating multiple stamps in one file, use one fence around the entire layout.





# SECTION 14: MATERIAL ENGRAVING TECHNIQUES

## Sending a Stamp File to the Laser

Select Stamp as your Raster Type.

With Stamp mode selected, you can change the shoulder and widening settings (explained below).

The mirror function mirrors everything except the lines to be cut. Only use if not cutting out the stamps with the laser. Mirror your artwork when setting up your file.

Check the Fence box if using the Fence Method.

File	Job Type	Resolution	Piece Size
FusionQualityTest	Vector	600 DPI	12.00 x

Once you have successfully setup your stamp artwork, you are ready to print your design. In the Laser Dashboard go to the Advanced tab.



If the Stamp Mode is not able to be selected, check on the General Tab that the Job Type selected is either Raster or Combined mode.

### Shoulder Settings



The Shoulder setting in the Dashboard adjusts the angle of the shoulders of your characters. A higher shoulder number provides a wider angle and more support for the characters. The following drawing shows a side view of a character with the shoulders set to 6, 25 and 50. Many users feel the default setting of 25 is ideal.

### Widening Settings



The Widening setting in the Dashboard adjusts the width of the character at its top. A higher Widening number provides a bolder character. The following drawing shows a side view of the difference in characters when their widening set to 1 or 6. (Note that the Shoulder doesn't change). Many users feel the default setting of 1 is ideal.

## SECTION 14: MATERIAL ENGRAVING TECHNIQUES

### Stamp Match

The last setting that you may need to make is made from the laser's control panel. The Stamp Match setting is defaulted to 0 which is ideal for most stamp applications. If you notice that there is a little jaggedness at the edges of your stamp letters, adjust the Stamp Match by one or two digits (either up to 1 or 2, or down to -1 or -2 etc). This feature fine tunes the left to right alignment of each raster line and should straighten out any rough edges that may appear. This is a setting that once set should never need to be changed again. To change the Stamp Match setting, refer to the Engraving Machine Calibration / Maintenance section in this manual.

### Wood

#### Solid Wood

Wood is by far the most laser friendly material available because it can be engraved or cut very easily. When engraved, lighter colored woods like Cherry or Maple produce very nice contrast where the laser burns away the wood. This high visual contrast is what makes lighter woods so popular when combined with a laser. There are many types of other wood products that are designed for use with the laser and many more that are waiting to be discovered by you.

Every type of wood has its own characteristics. Some wood is denser than other wood, with the denser, harder woods requiring more laser power to cut or engrave. Epilog recommends that when working with wood other than the ones listed in this section that you investigate the engraving and cutting characteristics before committing to use. There are woodworking shops in nearly every large city that will have a wealth of information on nearly all woods. If you have access to the Internet, search on wood to see what you find.

- The most common woods used with the laser are Cherry, Walnut, Maple, Alder, & Oak. These woods are considered hard woods, and have grains that work well with lasers.
- Grain can vary greatly in density. Cherry, Alder, Walnut & Maple all have fairly little veins of grain in them, while Oak has medium to large veins in it. For example: If a large box was engraved into a piece of Cherry and a piece of Oak, the box engraved into the Cherry would have a very uniform appearance, the area engraved or the background would be smooth with little variation in height. The Oak on the other hand would vary greatly in height and have a very non-uniform appearance.
- Cherry and alder are the most popular woods for engraving. The light, red color of these two woods provides an excellent contrast when engraved.
- **Engraving bare wood:** When engraving bare wood, the smoke and debris produced while engraving can become embedded into the grain of the wood. To reduce this effect, always engrave with the Bottom-Top setting in the driver.
- **Engraving stained wood:** A stained wood is preferable for engraving because excess smoke and debris can be wiped off the surface of the wood after engraving with water.

## SECTION 14: MATERIAL ENGRAVING TECHNIQUES

### Manufactured Wood Products

When choosing a manufactured wood product for engraving and cutting, we have found MDF to be vastly superior to plywood when working with a CO2 laser. Since plywood is constructed of layers of wood glued together and the grain of the wood chips in the plywood run in different directions, it is difficult to obtain a consistent depth when engraving. Air bubbles within the plywood cause problems because they severely disrupt the laser beam when cutting. Because of the glue, air bubbles and other factors it is virtually impossible to cut cleanly through plywood.

MDF is an engineered wood product with glued together wood fibers. Since there are not layers of wood glued together, like in the plywood, the engraving and cutting is much better. You will produce some charring on the edge of MDF when cut, so you may need to sand the edges after cutting.

### Wood Engraving Techniques

- To create a quality image on wood, contrast and depth are usually desired. The higher the power levels, the higher the contrast and depth will be.
- **Speed and Power Settings:** Wood is a great material to laser engrave because it discolors when engraved and the depth of engraving is greater than most materials. The downside is that it takes a lot of power to deeply engrave wood at high speeds. Most wood can be engraved using full power no matter whether you are using a 30-watt laser or a 120-watt laser. Depending on the wattage of your laser, the best approach is to set the laser power at 100% and adjust the speed to obtain the desired depth.
- **Resolution Settings:** Wood is a very easy material to work with and you can produce very nice detail with as little as 300 DPI engraving. 600 DPI engraving into wood produces fabulous results, especially on photos.
- **Gray Scales:** Gray scales look wonderful when engraved into wood. The reason for this is that the wood will react much differently to each level of gray scale, providing amazing contrast. Experiment! Take a piece of clipart and ungroup it and change the colors so that they range from a dark color like red, to a light color like yellow, then engrave it. This will create a shading effect that is almost 3-D in its appearance.

### Wood Vector Cutting Techniques

Epilog Laser Systems are ideal for cutting through solid wood material. The thickness of the wood that you can cut varies with the wattage of the laser and the hardness of the wood, but in general you can cut approximately ¼ inch (6.35 mm) wood with a 30-watt laser and up to ½ inch (12.7 mm) wood with a 120 watt laser.

- When cutting wood of any thickness, Epilog recommends the use of the Vector Cutting Table and Air Assist options. The Vector Cutting Table raises the wood off of the solid metal engraving table and supports the wood on an aluminum grid. The grid greatly reduces backside burning of the wood and also provides ventilation that allows the fumes and smoke to be exhausted to the rear of the engraving cabinet. Information regarding accessing the Vector Cutting Table is located in “**Vector Cutting Table/Vacuum Hold-Down Table**” on page 113.

## SECTION 14: MATERIAL ENGRAVING TECHNIQUES

- Air assist greatly reduces flaming that may occur if too much laser power is applied to the wood piece being cut.
- Depending on the type of wood being vector cut, it is sometimes advantageous to apply a cover of masking or transfer tape to the surface before cutting. The masking tape will reduce residue buildup on the top surface of the wood surrounding the cut line.
- Reduce the frequency settings in the driver to around 20 for a better laser cut edge. The laser will pulse less frequency, reducing the charring and burning on the side of the wood.
- If you are cutting through thicker materials, focus the table up so that the new 2" focal distance will be to the center of the wood.



**Warning:** Wood is a combustible material. Never leave your laser unattended while vector cutting any material. Air assist greatly reduces flaming that may occur if too much laser power is applied to the wood piece being cut. **Read the full “Fire Warning” on page 1 of the manual.**

### Wood Cleaning Techniques

When laser engraving or cutting wood, resin in the wood comes to the surface, mixes with the smoke and is deposited as a residue. If the wood has a coating of polyurethane or lacquer the coating protects the surface of the wood from the resin/smoke damage. You can remove the resin from coated materials with a wet chamois or a sponge with a web cover. Some people like to use 409, Windex or other mild cleaning product, but water works well and is usually the most readily available wetting agent. The chamois that Epilog recommends has a sponge in the middle of it, and is available in the automotive car wash section of many Target stores or many automotive supply shops.

- If the wood is not coated with polyurethane, the resin and smoke will stain the surface and you will need to sand the surface to remove the resin.
- Never use a paper towel to clean the wood surface. The paper towel will shred and it is impossible to get the shredded fibers out of the engraved recesses of the wood. Most wood products that are designed for laser engraving will have a polyurethane coating so that they are very easy to clean.

### Wood Color Filling Techniques

Color filling engraved areas of wood adds either greater contrast or a splash of color to your wood presentation. Normally, color filling is not required for lighter colored wood materials such as maple or cherry, but walnut can often benefit from adding a black color fill to provide more contrast. You will need to take some precautions when color filling wood, because if you are not careful, the liquid color fill material will absorb into the grain of the wood on the surface of the plaque where it is not wanted.

The best way to add a black color fill is shown below:

1. Apply a thin coat of Johnson’s Paste Wax to the surface of the wood before you engrave it.

## SECTION 14: MATERIAL ENGRAVING TECHNIQUES

2. Engrave through the paste wax into the wood. Do not wipe off excess paste or residue after engraving.
3. Fill the engraved voids with Turtlewax "Color Core" black liquid car polish. The car polish will absorb into the engraved wood grain, but will not absorb into the wood grain that is covered with paste wax.
4. Wrap a paper towel around a block of material that has a flat surface. Rub the flat surfaced paper towel over the surface of the wood to clean off the excess car polish and paste wax. The flat surface prevents the paper towel from getting into the engraved recesses.

### Fiber Laser Materials/Techniques

The fiber laser can etch and mark a wide variety of metals and plastics. Below are a few techniques for creating different marks including annealing, polishing and etching into metals, as well as information on plastic marking with the fiber laser.

#### Metal Annealing

Annealing can be done on most metals that contain high levels of carbon and metal oxides. These are generally, but not limited to, steel alloys, iron, titanium, cobalt, molybdenum, and chrome-plated iron/steel. To anneal, you must use a slow rate of speed to heat and change the surface color of the material, but a higher wattage Fiber laser will help reduce the cycle times.

To change the surface color without penetrating the metal, the laser beam's focal point is crucial in achieving a dark mark. An annealed mark is accomplished with the focal point up (closer to) .070" to .110" (1.778 to 2.794 mm) or down (further away) -.060" to -.090" (-1.524 to -2.286 mm) from zero. Adjusting the speed, focus and frequency setting will vary the contrast of mark generally resulting in shades of blue, purple and black.

The frequency is the amount of laser power per pulse. The lower the frequency, the more burst of power is being applied. Because we're intentionally applying a broader beam of laser light to achieve an annealed mark, frequency is almost always set in the lower 1-5% range.

For best results, print at 600 DPI. 1200 DPI should be considered for metals that are more difficult to anneal, if there is inconsistent color change at the recommended settings, or when cycle times aren't a concern. The extra overlapping of pixels offered at 1200 DPI will assure a deeper, darker mark.

#### Metal Etching

Deep metal engraving is a common application for the fiber laser. Using a slow speed setting doesn't necessarily equate to depth. Longer laser dwell time typically results in more eruption of metal, leaving a raised mark instead of deep penetration.

## SECTION 14: MATERIAL ENGRAVING TECHNIQUES

We find for the best deep metal etching, moderate speed settings (20-30%) and more passes slowly chip away at the metal for a better mark. Deep metal engraving requires maximum wattage. For these applications, a 30 or 50-watt fiber laser is recommended.

Frequency is generally set between the 1-5% range. A lower frequency range provides more bursts of laser power per pulse and is crucial to ablating the metal. We've found that focusing "into" the metal by .010" to .030" (.254 to .762 mm) helps in the removal of metal. No technical data is available on whether refocusing after each pass is helpful or not. To better assist in removing metal cleanly, higher resolution (1200 DPI) with more overlap of laser pulses tends to provide a cleaner, more defined etch.

Deep engraving will require multiple passes, which can be easily accomplished by changing the number of copies in the print dialogue box for CorelDRAW. As with all materials including metals, the hardness or grade will ultimately determine what settings and how many passes are needed to achieve a certain depth. Use the guidelines above as starting points and experiment for best results.

### Metal Polishing

Polishing of metals is accomplished by quickly heating up the metal's surface, changing its color, resulting in a mirror-like finish. Polishing can be done on just about any metal including, but not limited to, raw alloys, heat-treated metals, plated metals and precious metals.

For a high-contrast mark, polishing is best done on darker, matte finish metals. Cleaning the surface prior to processing is recommended as oils, grease and other chemicals can affect the consistency and finish of the final marks. Dialing in the settings for a polished mark is the most difficult of the three most popular metal marking techniques. Speed, power and frequency play the biggest role.

- Speed is generally set on the high side, 50-100%, depending on wattage.
- The power is set in the 30-60% range, depending on wattage.
- Frequency is also set on the higher side, typically around the 50-100% range. A higher frequency setting equates to less power per laser pulse. Too strong of a laser pulse and the laser beam starts penetrating the metal instead of polishing, resulting in a dull or browning effect.

Focus should be set at zero. Printing resolution is in the range of 300 to 600 DPI but is mostly done at 400 or 600. Start by determining your base speed, frequency and resolution setting. From there, select a power setting and start fine tuning by adjusting the power in 1% increments or decrements.

### Plastic Marking

The term "plastics" is commonly used to describe various grades and types of polymers. To keep things simple, we'll refer to all polymers as plastic. There are many plastics that are compatible with the fiber laser's 1062 nm wavelength of light. We refer to these as "engineered plastics" because many were designed to be laser-etched

## SECTION 14: MATERIAL ENGRAVING TECHNIQUES

at some point during the manufacturing life cycle. These plastics are doped with an additive that results in a contrasting mark when the 1062nm wavelength of light is applied.

There are many other plastics that work just as well as the engineered ones. It's amazing how many different plastics we receive for applications testing, most of the time their trade name and chemical composition aren't disclosed or are unknown. The guidelines below will help in your quest to provide the best possible mark.

Most plastics that tend to work on the FiberMark are those that are mold-injected and are physically hard. Industries where injection molded parts are common include automotive, aerospace, medical device and general manufacturing, to name a few.

Some of the more common compatible plastics include PET, ABS, polycarbonate and colored delrin. Some that are more difficult to mark using this wavelength of light include polyethylene, polypropylene and nylon.

Settings for processing plastics:

- Moderate to fast speed, typically in the 50-80% range.
- Moderate power, generally around the 30-60% range, depending on wattage.
- Medium to high frequency (50-100%) is helpful for processing plastics as it provides a steadier stream of laser power per pulse. Using a low frequency would result in inconsistent contrast and possibly cause foaming of the surface.
- Focus is generally left at zero. Adjusting the focus up or down in .010" (0.254 mm) increments can provide slightly better contrast but instead, consider adjusting the speed / power / frequency for the same effect.

Most plastics are processed at 600 DPI for high contrast and detail. Cycle times are generally fast, so dropping the resolution would only affect print quality. Increasing resolution may prove helpful only on those plastics that are difficult to mark. The majority of compatible plastics will provide a high-contrasting mark using the above settings. Darker plastics will turn white or varying shades of gray. Lighter plastics will turn dark gray to black. Fine tune the mark by increasing/decreasing power or frequency. Speed and focus can be left alone.

Incompatible plastics will either be transparent to the 1062 nm wavelength of light or will require the use of metal marking settings (low to medium speed, high power, and low frequency). The final mark for these plastics isn't as appealing, consistent or contrasting as their compatible counterparts.

Pigmentation of plastic can also dictate what settings are needed to produce a nice mark. The core polymer may be compatible, but due to chemicals used to add color, some colors may mark better than others. Having to adjust the printing parameters for different colors of the same compatible plastic is not uncommon.





# SECTION 15: SPECIFICATIONS

## Fusion Laser Technical Specifications

	Fusion M2 32 (CO2)	Fusion M2 32 (Fiber)	Fusion M2 40 (CO2)	Fusion M2 40 (Fiber)
Maximum Engraving Area	32" x 20" (812 x 508 mm)		40" x 28" (1016 x 711 mm)	
Max Material Thickness	13.5 (342 mm) (2" lens)	10.5" (266 mm) (3" lens)	13.25" (336 mm) (2" lens)	10.25" (260 mm) (3" lens)
	Dual Source 12.5" (317.5 mm) (3" lens)		Dual Source 12.25" (311 mm) (3" lens)	
Laser Source Wattages	30, 40, 50, 60, 75 or 120 watt, CO2, air-cooled, all-metal tube, 10.6 micrometers.	20, 30 or 50 watt, Fiber Laser. Air cooled, includes collimator. 1064 nm. Beam quality: M2 < 1.1.	30, 40, 50, 60, 75 or 120 watt, CO2, air-cooled, all-metal tube, 10.6 micrometers.	20, 30 or 50 watt, Fiber Laser. Air cooled, includes collimator. 1064 nm. Beam quality: M2 < 1.1.
Standard Features	Radiance High Definition Optics (CO2), Air Assist, Red Dot Pointer, relocatable Home Position, LED lighting, integrated floor stand, brushless servo motors, Super-Silent Cooling Fans, Joystick controls, removable exhaust plenum.			
	Dual Source Fusion M2: Available with combination of 50, 60 or 75 watt CO2 and 20, 30 or 50 watt Fiber.			
Intelligent Memory Buffer	Store unlimited files up to 128 MB. Rolling buffer allows files of any size.			
Operating Modes	Optimized raster, vector and combined modes.			
Motion Control System	High-speed, continuous-loop, brushless DC servomotors using rotary encoding technology for precise positioning.			
X-axis Bearings	Ground and polished, stainless steel, Teflon coated, self-lubricating bearings.			
Belts	Advanced B-style Kevlar belts (X-axis) and steel cord (y-axis).			
Resolution	User controlled from 75 to 1200 DPI.			
Speed and Power Control (engraving depth)	Computer controlled speed and power in 1% increments to 100%. Color mapping links speed, power, frequency, focus, and raster/vector mode settings to any RGB color.			
Print Interface	10Base-T Ethernet or USB connection. Compatible with Windows XP/Vista/7/8/10 and Mac OS X 10.7 and up.			
Size (W x D x H)	52.5" x 35.5" x 40.75" (1334 x 851 x 1035 mm) 34.25" (870 mm) deep with Exhaust Plenum		60.5" x 41.25" x 42.25" (1537 x 1048 x 1073 mm) 43" (1092 mm) deep with Exhaust Plenum	
	500 lbs (227 kg)	500 lbs (227 kg)	643 lbs. (292 kg)	643 lbs. (292 kg)
Weight	Dual Source: 536 lbs (243 kg)		Dual Source: 679 lbs (307 kg)	
Electrical Requirements	Auto-switching 110 to 240 volts, 50 or 60 Hz, single phase, 15 amp AC.			
Ventilation Systems	650 CFM (1104 m3/hr) external exhaust to the outside or internal filtration unit is required. There are two output ports, 4" (102 mm) in diameter.			
Laser System Classification	Class 2 Laser Product - 1 mW CW MAXIMUM 600-700 nm.			

**Technical specifications and product configurations subject to change without notice.**

### Compatibility

Your Epilog Laser has been designed as an “open architecture” product that can be run from almost any Windows based software. Epilog provides both Windows 32-bit and 64-bit print drivers, as well as a Beta version of a Mac driver for OS X 10.7 and higher.

### Recommended PC

#### For Optimum Computer Performance

Investing in a new computer is a great way to make sure you’re getting the most out of your new laser equipment. Why? Because today’s software (CorelDraw for instance) requires a lot of computer processing speed and memory to function properly. A good computer won’t make a big difference in how your laser runs, but when compared to a slow computer it will save untold amounts of time and frustration setting up the artwork that you “print” to the laser. Many users do not purchase new computers for use with their new laser because their current computers are perfectly adequate. There’s no magical cut-off that makes a computer too slow. If you’re comfortable with the performance and speed of your current computer, there’s probably no reason to purchase another one. The following recommendations are just advice to consider if a new computer is necessary.

A new computer doesn’t have to be expensive to work great. Even many of today’s lower cost computers work great for laser applications. Read these recommendations and consider spending just a few dollars more for those components that will save you time and frustration.

#### Operating System

While the laser is compatible with Windows 32-bit or 64-bit XP, 2000, Vista, Windows 7 and newer operating systems, as well as OS X 10.7 and higher, the Epilog Job Manager will work with Windows 7 and newer.

#### RAM – Random Access Memory

4 GB is the minimum that is recommended. RAM is like short-term memory. It’s fast and readily available for the computer to access and makes time consuming tasks go much quicker if you have lots of it. Having more than 2 GB of RAM is nice if you demand a lot from your computer.

#### Processor Speed

A faster processor will allow you to do more tasks in less time. While it’s not necessary to purchase the fastest processor available, you’ll want adequate speed to operate your graphics program. Processor speeds are always improving, but processor speeds of about 2.0 GHz or faster are a good place to start.

#### 10/100 Network Interface Card (NIC)

All new computers have a 10/100 network connection as standard equipment. As well as allowing multiple computers to be linked together in a network, this technology also allows direct printing from the computer to the laser. Epilog supplies a network Crossover cable with each laser system that allows one computer to print to a single Epilog Laser system.

### Hard Drive

This is the permanent memory in your computer. Many users feel that you can never have a large enough hard drive. Luckily, most computer manufacturers put high capacity drives in new computers these days. When in doubt, buy bigger than you think you might need. It's so in-expensive that it's worth the peace of mind to have it available.

### Software

Many users use Corel as their graphics software. Many other Windows software applications can also be used, although all software is different and may not be predictable, user friendly or functional. Additionally, the technical support staff at Epilog may be less familiar with software other than Corel and less able to help with questions. Consult with your Epilog distributor on software compatibility issues. Epilog does not guarantee compatibility with any software.

PhotoLaser Plus is a third party software for converting photos to laser compatible format. This is an indispensable option for engraving photos. For more information **see "PhotoLaser Plus" on page 148.**

### Heavy Duty Surge Protector

The need for a surge protector varies greatly throughout the world. If the laser is operated anywhere that the electrical power is subject to spikes, outages, lighting, fluctuations, etc, a surge protector should be used on both the laser and the computer. A surge protector is a very cheap insurance policy against catastrophic electrical damage. A surge protector is designed to be an inexpensive device that absorbs any electrical problems before they can damage the expensive equipment (computer and laser) they are protecting.

## About The CO2 Laser Source

Your Epilog CO2 laser system uses the latest in laser technology to provide a powerful tool that is simple and safe to setup and operate. The Epilog Laser can mark, engrave, and cut a variety of non-metallic materials.

The CO2 laser beam itself is invisible and operates at a wavelength of 10.6 microns. The beam is about half the diameter of a #2 pencil. Unfocused, it will just make an ugly burn, leaving lots of charred material behind. The focus lens gives the beam an hourglass shape. At the center point the energy density is concentrated, allowing the very precise and clean material removal that is characteristic of laser engraving. The center of the hourglass is the focal point.

The laser beam path is completely enclosed within the cabinet. Please do not disassemble or modify any of the covers or windows on the machine. If at any time you notice that the laser operates with a door or window open, please contact Epilog technical support immediately.

The laser has two basic operating methods. For cutting (vector), the laser is driven along a path and the laser is left on all the time. The path could be the outline of a letter or a geometric shape like a circle. The laser will cut entirely through the material, separating the part from the background. For marking (engraving), the laser is swept across the work from left to right, and the laser is turned on and off at the correct points to produce the first line of the image. Then the carriage advances one line and the process is repeated, eventually assembling a full image.

### About the Fiber Laser Source

The fiber laser source generates a laser beam by pumping intense diode light into the end of fiber optic cables that have been doped with ytterbium. The energy from the diode light is absorbed by the ytterbium in the fiber optic cables. The ytterbium then releases the energy in the form of photons that travel down the optic cables. The photons that leave the optic cables create the laser beam. The wavelength of light generated from a fiber laser is 1062 nm.

The fiber laser source generates laser light by pumping intense diode light into fiber optics cables that are doped with the rare-earth element, ytterbium (Yb<sup>3+</sup>), which is referred to as the medium or gain medium. As this diode light energy travels into the fiber optic cable, it energizes the electrons in the ytterbium and the ytterbium electrons go from a ground or stable state, to an excited state.

Essentially, all that is happening in this first step is that the electrons in the medium are absorbing and storing the energy that's coming from the external energy source (diodes). For reference, the CO<sub>2</sub> medium is the CO<sub>2</sub> gas in the tube, and the external energy source is RF electrical current. In the fiber laser (and also most YAG lasers these days and YVO lasers) the external energy source is a laser diode.

The electrons in the medium don't really want to store the external energy they've absorbed, so they emit the extra energy by releasing a photon (a quantum packet of light). Once a photon has been emitted by one electron in the medium it stimulates other excited electrons to also emit photons, creating a chain reaction where the absorption and emission of energy is at a constant rate. The photons travel through the optic fibers and some are released through the end of the fibers as the laser beam.

By continually pumping energy into a medium, that medium tries to shed the excess energy by emitting photons. The type of medium is important because different mediums absorb different types of energy (for instance, a CO<sub>2</sub> gas medium is not going to absorb the energy from a diode in a way that will make the CO<sub>2</sub> gas lase). Different mediums also emit different wavelengths of photons, and hence, the different properties of different wavelength lasers.

### Federal Communications Commission (FCC) Notice



This equipment has been tested and found to comply with the limits for a Class A digital device, pursuant to Part 15 of the FCC rules. These limits are designed to provide reasonable protection against harmful interference when the equipment is operated in a commercial environment. This equipment generates, uses, and can radiate radio frequency energy; and, if not installed and used in accordance with the instruction manual, may cause harmful interference to radio communications. Operation of this equipment in a residential area is likely to cause harmful interference, in which case the user will be required to correct the interference at his/her own expense.

# SECTION 16: TECHNICAL SUPPORT

Contacting Technical Support

## Contacting Technical Support

The technical support department at Epilog is available to assist with solving problems you may encounter using your Epilog. Please review first the common problems and solutions as noted below, then if you are still in need of assistance you may contact Epilog's technical support department at the number or website listed below. Technical support is available in Golden, Colorado USA during the hours of 6 a.m. and 6 p.m. Mountain Time.



**Technical Support Direct Line:** 1 (303) 215-9171

**Email:** [tech@epiloglaser.com](mailto:tech@epiloglaser.com)

**Technical Support Online:** [support.epiloglaser.com](http://support.epiloglaser.com)

## What to do prior to contacting Epilog Technical Support:

1. Have the machine serial number available.
2. Have time to work on machine. Many issues will require troubleshooting.
3. Clean your machine (especially the optics), this will solve many issues.

The machine serial number can be found on the Certification/Identification Label. This engraved plate is located on the back of the machine's cabinet. The ID label shown is for the Model 13000 75-watt product.

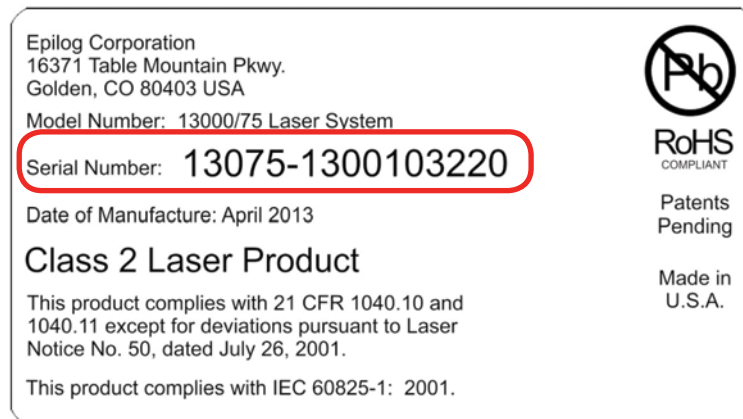

### Frequently Asked Questions

#### Engraver Will Not Vector

1. Verify that the print driver is set to Vector or Combined mode.
2. Verify that the lines that you want to vector are set to .001" (0.025 mm).
3. Make sure the images are vector lines. Scanned and raster images will not vector.
4. Filled or solid images will not vector (outlines only).

#### Vector Cutting Is Erratic out of CorelDRAW

You have not set the "Send beziers and paths to driver in CorelDRAW. For more information, see **"Setting Up CorelDRAW Beziers Setting"** on page 31. If this does not work, contact Technical Support at +1 (303) 215-9171.

#### Engraving Appears Lighter Than Usual

1. All mirrors and lenses need to be cleaned and inspected for damage. See **"Cleaning the Optics"** on page 85 for cleaning instructions.
2. Verify that the lens is in correct focus.
3. Verify correct Speed, Power and Frequency settings for the type of material that you are engraving.

#### The Exhaust Is Not Pulling Enough Air

1. Move the blower closer to the machine. The closer the two are, the better exhaust you will receive.
2. Clean your exhaust system on a regular basis, including the engraver and blower. Use a bottle-brush and a vacuum on the areas where the exhaust buildup accumulates.

#### The Engraving Quality is Poor/Blurry/Double Image

1. If you feel you are not getting quality you once were, this is probably a maintenance issue. See **"Cleaning & Maintenance"** on page 85.
2. Clean the lenses of the system. See **"Cleaning the Optics"** on page 85 for cleaning instructions.

3. If you are experiencing a double image problem or other quality issue, it is best to run a sample and send a photo to: tech@epiloglaser.com.

### The Laser Won't Turn On

Make sure the Emergency Stop key the front of the machine is not pressed in.

### When I Use the Joystick to Focus the Table, the Table is Moving Slowly

You are in "Fine" focus mode where the table moves up in small increments. Tilt the Joystick to the left or right to toggle between fine and course movement. **For more information, see "Job" on page 67.**

### The Laser isn't Communicating with My Computer

1. Is the computer's TCP/IP address set to a different number than the IP address of the laser? **See "8. Set Up TCP/IP Address in the Computer" on page 17.** (If you have the eView Camera Module enabled, this should be set to Obtain an IP Address automatically.)
2. Is the computer's ethernet connection enabled? Go to the **Network and Sharing Center**, select **Change Adapter Settings**. If the Local Area Connection says Disabled, right click and choose Enable.

### The e-View Camera Module is Showing a Blurry/Double Image?

The camera needs to be realigned. For the latest instructions on Aligning the Cameras, **see "Checking Camera Calibration" on page 141.**

### The eView Camera isn't Showing an Image

The Dust Shutter is closed on the camera. Slide the gray metal piece next to the camera out and away from the camera to open.

### How Can I Increase the Life of my Laser System?

- **Clean your system:** Debris in the laser and on the mechanics of the system can reduce the life of parts in your system. Wipe down your system on a regular schedule to keep the mechanics clean and long lasting.
- **Clean the lenses:** Lens life is greatly increased by keeping them clean and free of debris. Get in the habit of wiping them off on a regular schedule to keep them clean and well maintained.

- **Reduce speed when running very small items:** When you run at 100% speed on a graphic with a very short stroke, the lens assembly comes up to speed and slows down extremely quickly, which can place wear on the mechanics of the laser. Slow down to 80 - 90% speed and increase the lifetime of your laser system.

### How to Shorten Your Engraving/Cutting Time

- **Lower the Resolution:** How important is the highest resolution image? Processing jobs at 400 DPI vs. 600 DPI can reduce cycle times by up to 30%, and processing at 300 DPI could mean half the cycle time.
- **Reduce White Space:** Orientate the parts to minimize engraving dead space (area where head travels, but has nothing to engrave).
- **Horizontal Layout:** If an option, horizontal text will engrave faster than vertical or curved (fit text to curve) text.
- **Color Mapping:** Use the Color Mapping feature to save time by adjusting the order in which the objects engrave/mark.
- **Run Multiples:** If you need to engrave multiples of the same image. You'll find you have a time savings per piece.

If these do not correct your issue or your issue is not listed, please contact the Technical Support Team at +1 303-215-9171 or [tech@epiloglaser.com](mailto:tech@epiloglaser.com).



# SECTION 17: MATERIAL SUPPLIERS

Industry Material Supplier List

## Industry Material Supplier List

The following list contains supplier information for materials typically used with your Epilog Laser. Additional suppliers and links can be found on our website at [http://www.epiloglaser.com/industry\\_links.htm](http://www.epiloglaser.com/industry_links.htm).

### Acrylic

#### Acrylic Idea Factory

Norcross, GA  
800-543-9253  
[www.acrylicidea.com](http://www.acrylicidea.com)

#### Dimension Espacio

Naucalpan, Mexico  
Phone (52)(55) 5312-0333  
[www.dimensionespacio.com.mx](http://www.dimensionespacio.com.mx)

#### Inventables

Chicago, IL  
312-775-7009  
[www.inventables.com](http://www.inventables.com)

#### Polycrylic

Norton, VT  
800-809-4217  
[www.polycrylic.com](http://www.polycrylic.com)

#### RB Fabrication

Orange, CA  
877-790-1160  
[www.rbfabrication.com](http://www.rbfabrication.com)

#### U.S. Plastic Corp

Lima, OH  
800-809-4217  
[www.uplastic.com](http://www.uplastic.com)

### Cermark

#### CerMark Metal - Ferro

Mayfield Heights, OH  
800-245-4951  
[www.cerdecmark.com](http://www.cerdecmark.com)

### JDS

Sioux Falls, SD  
800-843-8853  
[www.jdsindustries.com](http://www.jdsindustries.com)

#### LaserBits, Inc.

Phoenix, Arizona  
623-879-0005  
[www.laserbits.com](http://www.laserbits.com)

### Custom Artwork and Graphics

#### Cascade Metal Designs

Darrington, WA  
425-530-6606  
[www.freedxf.com](http://www.freedxf.com)

#### Digital Art Solutions

Tempe, AZ 85281  
800-959-7627  
[www.digitalartsolutions.com](http://www.digitalartsolutions.com)

#### Gantry Company (3D Graphics)

Chippewa Falls, WI  
715-288-6100  
[www.gantryco.com](http://www.gantryco.com)

#### Laser Pattern Werx

Nehalem, OR  
503-368-3194  
[www.etsy.com/shop/laserpatternwerx](http://www.etsy.com/shop/laserpatternwerx)

### Color Fill Materials

#### Smoke-Wood

Elgin, OR  
800-248-2352  
[www.smoke-wood.com](http://www.smoke-wood.com)

### Corian and Fountainhead

#### Johnson Plastics

Minneapolis, MN  
800-869-7800  
[www.johnsonplastics.com](http://www.johnsonplastics.com)

### Cork

#### Jelinek Cork Group

Savannah, GA  
800-959-0995  
[www.thecorkstore.com](http://www.thecorkstore.com)

### Educational Materials

#### CoreIDRAW Help

Albany, OR  
[www.coreldrawhelp.com](http://www.coreldrawhelp.com)

### Fabric

#### Twill USA

Aurora, IN  
866-806-9120  
[www.twillusa.com](http://www.twillusa.com)

#### Webster Fabrics

Chesterfield, MO  
800-845-4323  
[www.websterfabric.com](http://www.websterfabric.com)

### Glass

#### DiscountMugs.com

800-569-1980  
[www.discountmugs.com](http://www.discountmugs.com)

## SECTION 17: MATERIAL SUPPLIERS

Industry Material Supplier List

**Gold Coast Graphics**  
Huntinton Beach, CA  
888-733-0061  
www.goldcoastgraphics.com

**Max Gift International**  
Beaverton, OR  
503-579-9804  
www.max-gift.com

### Laser Engraveable Products

**LaserBits, Inc.**  
Phoenix, Arizona  
623-879-0005  
www.laserbits.com

**LaserGifts**  
Prescott, AZ  
888-674-6612  
www.lasergifts.com

### Leather (and Laserable Faux)

**Tandy Leather Factory**  
Forth Worth, TX  
800-433-3201  
www.tandy-leather.com

**JDS**  
Sioux Falls, SD  
800-843-8853  
www.jdsindustries.com

### Marble

**Marble Max**  
www.max.com

**Jon-Ko**  
San Diego, CA 800-537-9092  
www.jon-ko.com

**Laser Sketch**  
Romeoville, IL  
630-243-6360  
www.lasersketch.com

### Medals (Engraveable)

**Catania**  
Avon Lake, OH  
800-633-2586  
www.cataniainc.com  
**Metals (Engraveable)**

**AlumaMark**  
Cleveland, OH  
800-482-7758  
216-475-0555  
www.horizonsisg.com

**Identification Plates, Inc.**  
Mesquite, TX  
800-395-2570  
www.idplates.com

**Inland Products**  
Riverside, CA  
800-481-5500  
www.inlandproducts.com

**JDS**  
Sioux Falls, SD  
800-843-8853  
www.jdsindustries.com

**NapTags**  
Grand Rapids, MI  
800-451-3330  
www.NapTags.com

**R.S. Owens & Company**  
Chicago, IL  
800-282-6200  
www.rsowens.com

**Victory**  
Chicago, IL  
800-327-5578  
www.buyvictory.com

### Metal Marking Solution

**CerMark Metal - Ferro**  
Mayfield Heights, OH  
800-245-4951  
www.cerdecmark.com

**JDS**  
Sioux Falls, SD  
800-843-8853  
www.jdsindustries.com

**LaserBits, Inc.**  
Phoenix, Arizona  
623-879-0005  
www.laserbits.com

### Mother of Pearl

**Duke of Pearl**  
Lusby, MD  
410-231-2641  
www.dukeofpearl.com

**Aqua Blue Maui, LLC**  
Kula, HI  
808-876-0217  
www.aquablumaui.com

### Paper/Pressboard

**Taskboard**  
Miami, FL  
800-401-0346  
www.taskboard.com

## SECTION 17: MATERIAL SUPPLIERS

Industry Material Supplier List

### Pen and Pencil Sets

IMARK Pen Co.  
Arlington, TX  
817-385-0306  
www.IMARK-Pen.com

### Plastics (Engraveable)

**Colorado Plastic Products**  
Lakewood, CO  
303-443-9271  
www.coloradoplastics.com

### Innovative Plastics

Algonquin, IL  
815-477-0778  
www.inoplas.com

### JDS

Sioux Falls, SD  
800-843-8853  
www.jdsindustries.com

### Johnson Plastics

Minneapolis, MN  
800-869-7800  
www.johnsonplastics.com

### Rowmark

Findlay, OH  
800-243-3339  
www.rowmark.com

### Southeast Plastics

866-491-9044  
www.southeastplastics.com

### Pressboard Plaques

### JDS

Sioux Falls, SD  
800-843-8853  
www.jdsindustries.com

### PDU

South El Monte, CA  
800-800-7711  
www.pdu.com

### Slate

**Laser Slate**  
866-491-9044  
www.laserslate.com

### Sports Materials

### MiniSticks

Buffalo, NY  
866-646-4784  
www.ministicks.com

### Tapes and Foils

### Innotech of Wisconsin

Racine, WI  
800-776-7194  
www.innotape.com

### Wood: Plaques and Specialty Products

### Colorado Heirloom

Loveland, CO  
970-667-4222  
www.coloradoheirloom.com

### Lee's Wood Products

Rocky Mount, VA  
800-552-5337  
www.leeswoodproducts.com

### Stanton Mfg. Co. Inc.

Lake Ozark, MO  
573-365-2441  
www.stantmfg.com

### Thinwoods.com

Wilmington, NC  
910-343-9000  
www.thinwoods.com

### Wood Design/WDI

Forest Lake, MN  
800-354-0196  
651-464-6190  
www.thewoodster.com



# APPENDIX A: WARRANTY STATEMENT

Warranty Statement for the Fusion Laser

## Warranty Statement for the Fusion Laser

Epilog Corporation warrants to the original purchaser of Epilog Fusion Models 13000/14000 that the product will be free from defects in material or workmanship when purchased, and under proper, normal use within two (2) years from the original date of purchase, with the exception of the motors which are warranted for three (3) years from the original date of purchase.

Epilog will replace or, at its option, repair the defective part(s). Normally, Epilog will supply a replacement part for the customer to replace. Once the replacement has been performed, the replaced part must be returned to Epilog. In the case where repair is required, Epilog requires that the defective part, or machine, be returned to the Epilog factory or other Epilog designated facility. Epilog will be responsible solely for the cost of repairs, including parts and labor, which are made at an authorized Epilog facility. All other costs for replacement or repair, including, but not limited to, packaging and shipping both to and from Epilog, shall be paid by the owner. A "Core" charge may be required by Epilog to insure the return of replacement and repair parts. This warranty excludes any damage from abuse (including, without limitation, incorrect voltages, power surges, fires, improper or insufficient ventilation "acts of God" or other situations out of the control of Epilog), failure to operate in accordance with instructions provided in the Owner's Manuals for the Epilog models 13000, including specific safety and operational warnings contained therein, cosmetic damage sustained in use, and damage caused by unauthorized modifications of any equipment. All warranties to original purchasers are non-transferable. The registered owner must initiate warranty claims within the warranty period.

**THE ABOVE AND FOREGOING IS THE ONLY WARRANTY OF ANY KIND, EITHER EXPRESS OR IMPLIED; INCLUDING BUT NOT LIMITED TO ANY WARRANTIES OF MERCHANTABILITY AND FITNESS FOR A PARTICULAR PURPOSE, THAT ARE MADE BY EPILOG ON MODEL 13000. ANY WARRANTIES IMPLIED BY LAW ARE HEREBY EXPRESSLY DISCLAIMED.**

No oral or written information or advice given by Epilog, its dealers, its distributors, agents, officers, or employees shall create a warranty or in any way increase the scope of this warranty. Neither Epilog nor anyone else who has been involved in the creation, production, or delivery of the Epilog Fusion Models 13000/14000 shall be liable for any direct, indirect, consequential, or incidental damages, including but not limited to damages for loss of business profits, business interruption, loss of business information, adverse health impacts, fire, and the like, arising out of the use or inability to use these products.

Epilog Corporation provides no warranties whatsoever on any software used in connection with Epilog Fusion Models 13000/14000.



# APPENDIX B: MATERIAL SETTINGS

Fusion Series Suggested Material Settings (CO2)

Fusion Series Suggested Material Settings (CO2)							
Material	DPI/Freq.	30 watt	40 watt	50 watt	60 watt	75 watt	120 watt
<b>Acrylic</b>							
Photo Engraving	300 DPI	90s 60p	90s 55p	90s 50p	90s 45p	90s 40p	90s 30p
Text/Clipart Engraving	300 DPI	90s 80p	90s 75p	90s 70p	90s 65p	90s 60p	90s 55p
Text/Clipart Engraving	600 DPI	90s 75p	90s 70p	90s 65p	90s 60p	90s 55p	90s 50p
Cutting 1/8" (3 mm)	100 f	5s 100p	6s 100p	7s 100p	8s 100p	10s 100p	12s 100p
Cutting 1/4" (6 mm)	100 f	2s* 100p	3s* 100p	1s 100p	2s 100p	3s 100p	7s 100p
Cutting 3/8" (9.5 mm)	100 f			2s* 100p	3s* 100p	1s 100p	3s 100p
Cutting 1/2" (13 mm)	100 f						1s 100p
<p>Cutting Note: Adjusting the standard focus distance so it is closer to the lens by about .080" (2 mm) will produce better edge quality when cutting 1/4" (3mm) acrylic and thicker. Two passes can be used for cutting thicker materials. There are two types of acrylic: cast is better for engraving (it creates a frosted look when engraved) and extruded acrylic produces a much better flame polished edge.</p> <p>* The Fusion has two sets of Speed control for vector cutting applications. Checking the Speed Comp selection box in the print driver will reduce the speed setting you have selected by one half. Speed Comp is most useful for speeds of 1 to 10. Example: Cut a square at 5% speed. Then repeat the job at 5% speed and also select Speed Comp. The second square will take twice as long to cut as the first square. Speed Comp gives you more slower speed setting to work with. Always use Air Assist when cutting.</p>							
<b>Alumamark</b>							
Engraving	300 DPI	90s 55p	90s 45p	90s 35p	90s 25p	90s 20p	90s 15p
Engraving	600 DPI	90s 45p	90s 35p	90s 25p	90s 15p	90s 10p	90s 5p
<b>Anodized Aluminum</b>							
Photos/Clipart	400 DPI	90s 55p	90s 50p	90s 45p	90s 40p	90s 35p	90s 30p
Photos/Clipart	600 DPI	90s 50p	90s 45p	90s 40p	90s 35p	90s 30p	90s 25p
Text	600 DPI	90s 60p	90s 55p	90s 50p	90s 45p	90s 40p	90s 35p
We find when engraving anodized aluminum, text appears best at 600 DPI, but photos and clipart can be engraved with great detail down to 400 DPI.							
<b>Cork</b>							
Engraving	300 DPI	90s 50p	90s 45p	90s 40p	90s 35p	90s 30p	90s 25p
<b>Fleece</b>							
Engraving	150 DPI	90s 35p	90s 30p	90s 25p	90s 20p	90s 15p	90s 10p
When engraving fabric, try changing the graphic to 80% gray and use the Jarvis dithering pattern for the best results. Every fabric you are cutting will need to have adjusted setting - find a small swatch of the fabric you can test first.							
<b>Glass</b>							
Engraving	300 DPI	15s 100p	20s 100p	25s 100p	30s 100p	35s 100p	40s 100p
When etching glass, try changing the graphic to 80% gray before engraving and using the Jarvis dithering pattern. You can also diffuse heat by covering the glass with a thin sheet of dish soap.							
<b>Leather</b>							
Photo Engraving	300 DPI	90s 40p	90s 35p	90s 30p	90s 25p	90s 20p	90s 15p
Text/Clipart Engraving	600 DPI	90s 45p	90s 40p	90s 35p	90s 30p	90s 25p	90s 20p
Cutting 1/8" (3 mm)	50 f	50s 100p	45s 100p	40s 100p	35s 100p	30s 100p	25s 100p
<b>Mat Board</b>							
Cutting	50 f	20s 60p	20s 50p	25s 40p	25s 30p	30s 40p	30s 30p

# APPENDIX B: MATERIAL SETTINGS

## Fusion Series Suggested Material Settings (CO2)

### Fusion Series Suggested Material Settings (CO2)

Material	DPI/Freq.	30 watt	40 watt	50 watt	60 watt	75 watt	120 watt
<b>Marble</b>							
Photo Engraving	300 DPI	90s 55p	90s 50p	90s 45p	90s 40p	90s 35p	90s 25p
Text Engraving	600 DPI	90s 65p	90s 60p	90s 55p	90s 50p	90s 45p	90s 35p
Every marble is very different for settings. Start low and increase the power with a second run if you haven't used that marble before.							
<b>Painted Brass</b>							
Engraving	300 DPI	90s 45p	90s 40p	90s 35p	90s 30p	90s 25p	90s 15p
Engraving	600 DPI	90s 40p	90s 35p	90s 30p	90s 25p	90s 15p	90s 10p
<b>Plastics</b>							
Engraving	300 DPI	90s 40p	90s 35p	90s 30p	90s 25p	90s 20p	90s 15p
These settings work well with many plastics, including plastic phones and covers. Even one color plastics can achieve a great look when engraved.							
<b>Plastic (2 Layer Laser Engraveable)</b>							
Engraving	300 DPI	90s 80p	90s 75p	90s 70p	90s 65p	90s 40p	90s 35p
Engraving	600 DPI	90s 75p	90s 65p	90s 50p	90s 35p	90s 25p	90s 20p
Cutting 1/16" (1.5 mm)	100 f	10s 85p	10s 75p	10s 65p	10s 55p	10s 40p	20s 40p
<b>Rubber Stamps</b>							
Engraving	600 DPI	15s 100p	20s 100p	30s 100p	40s 100p	60s 100p	80s 100p
Cutting	100 f	5s 100p	10s 100p	15s 100p	20s 100p	25s 100p	30s 100p
<b>Stainless Steel w/Cermark</b>							
Engraving	600 DPI	20s 100p	25s 100p	30s 100p	35s 100p	45s 100p	55s 100p
<b>Twill</b>							
Cutting	25 f	50s 40p	50s 35p	70s 100p	90s 100p	90s 80p	90s 60p
<b>Wood</b>							
Photo Engraving	600 DPI	30s 100p	40s 100p	50s 100p	60s 100p	70s 100p	100s 100p
Clipart/Text Engraving	300 DPI	20s 100p	30s 100p	40s 100p	50s 100p	60s 100p	90s 100p
Clipart/Text Engraving	600 DPI	25s 100p	35s 100p	45s 100p	55s 100p	65s 100p	85s 100p
Deep Engraving	600 DPI	5s 100p	10s 100p	20s 100p	25s 100p	30s 100p	60s 100p
Thin Veneer (Cutting)	10 f	30s 100p	30s 80p	40s 100p	40s 90p	50s 80p	50s 60p
Cutting 1/8" (3 mm)	10 f	3s 100p	6s 100p	8s 100p	10s 100p	20s 100p	40s 100p
Cutting 1/4" (6 mm)	10 f	3s* 100p	1s 100p	2s 100p	3s 100p	5s 100p	12s 100p
Cutting 3/8" (9.5 mm)	10 f			2s* 100p	3s* 100p	1s 100p	8s 100p
Cutting 1/2" (12 mm)	10 f						3s 100p
When cutting wood, multiple passes may allow cutting of thicker materials. Using Color Mapping you can adjust the focus point between passes down to the center point of the cut for the best results.							
* The Fusion has two sets of Speed control for vector cutting applications. Checking the Speed Comp selection box in the print driver will reduce the speed setting you have selected by one half. Speed Comp is most useful for speeds of 1 to 10. Example: Cut a square at 5% speed. Then repeat the job at 5% speed and also select Speed Comp. The second square will take twice as long to cut as the first square. Speed Comp gives you more slower speed setting to work with. Always use Air Assist when cutting.							



## APPENDIX B: MATERIAL SETTINGS

### Fusion Series Suggested Material Settings (CO2)

- **These are only suggestions:** Every type of material will react differently with the laser, even from one plastic to the next. Use these settings as your starting point then adjust one variable at a time until you achieve the result you desire. Settings for any material are a matter of personal preference. Not every material that can be run at high speed should be run at high speed. A better mark can often be achieved by slowing your laser and giving the laser longer to react to your material.
- **Test your material:** If you have a small area of the material you won't be using, or an extra item, take advantage of this area to test out your settings by engraving a small square or cutting a small circle. You can fine tune your settings in these areas.
- **Similar materials use similar settings:** When you are working with a material you aren't familiar with, think about a similar material and what settings you would use with that product. Most anodized aluminums will react well with similar settings, as will most plastics.
- **When in doubt, start low:** Remember, you can always re-run your job as long as you don't move it in the machine. Let's say you're running a photograph in a one-of-a-kind wood plaque. Start with a lower power setting, look at the engraving, then run the project a second time at high speed and lower power a second time to add a little more depth if needed.
- **Run only one part of the file:** If running a job on a new material, you can always just select one piece of the engraving, like a piece of text, and run that part first to make sure your settings are perfect before running the whole file.



To print a copy of these settings to keep next to your laser, go to [www.epiloglaser.com/material-settings.htm](http://www.epiloglaser.com/material-settings.htm).

# APPENDIX B: MATERIAL SETTINGS

Fusion Series Suggested Material Settings (Fiber)

## Fusion Series Suggested Material Settings (Fiber)

Material	DPI/Freq.	20 watt	30 watt	50 watt
<b>Aluminum (Anodized)</b>				
<b>Etching/Marking</b>	600 DPI	Speed: 30 - 40% Power: 100% Frequency: 1% Focus: +.06 to +07	Speed: 40 - 50% Power: 100% Frequency: 1% Focus: +.06 to +07	Speed: 50 - 60% Power: 100% Frequency: 1% Focus: +.06 to +07
The contrast / brightness of marks achievable on the fiber laser are excellent and can often be much brighter than marks from a CO2 laser. Taking the fiber laser out of focus by +.06" - .09" broadens the beam and produces a very bright mark on anodized coating. Lower frequency and higher power settings help offset the change in focal point. Different grades of anodized & core aluminum alloy will affect how the final marks look.				
<b>Aluminum (Bare)</b>				
<b>Etching/Marking</b>	600 DPI	Speed: 20 - 30% Power: 100% Frequency: 50 - 60% Focus: -.01 to +.01	Speed: 30 - 40% Power: 100% Frequency: 50 - 60% Focus: -.01 to +.01	Speed: 40 - 50% Power: 100% Frequency: 50 - 60% Focus: -.01 to +.01
Engraving aluminum will result in various shades of gray, not black. Fine tuning the settings can provide a bit more contrast but the range of applicable marks is very narrow. If the application calls for a black etch, consider using an oxidizer after engraving. Oxidizers are used most commonly if the aluminum has a protective coating (urethane, clear coat, clear anodized) covering the area that is not engraved. Deep metal engraving on aluminum can be done using multiple passes. Consider deep engraving and using a black epoxy/color fill. Although the marks on aluminum are not black like they are on steel, we have no difficulty getting 2D, UID barcodes to scan and verify				
<b>Brass</b>				
<b>Etching/Marking</b>	600 DPI	Speed: 20 - 30% Power: 100% Frequency: 5 - 20% Focus: 0	Speed: 30 - 40% Power: 100% Frequency: 5 - 20% Focus: 0	Speed: 40 - 50% Power: 100% Frequency: 5 - 20% Focus: 0
<b>Laserable Plastic</b>				
<b>Etching/Marking</b>	600 DPI	Speed: 40 - 50% Power: 60-70% Frequency: 50% Focus: 0	Speed: 50 - 60% Power: 60-70% Frequency: 50% Focus: 0	Speed: 60 - 70% Power: 60-70% Frequency: 50% Focus: 0
<b>Stainless Steel</b>				
<b>Annealing</b>	600 DPI	Speed: 5-10% Power: 100% Frequency: 1% Focus: +.08 to +.110	Speed: 7-12% Power: 100% Frequency: 1% Focus: +.08 to +.110	Speed: 10 -15% Power: 100% Frequency: 1% Focus: +.08 to +.110
<b>Etching/Marking</b>	600 DPI	Speed: 20 - 30% Power: 100% Frequency: 1-5% Focus: -.01 to +.01	Speed: 30 - 40% Power: 100% Frequency: 1-5% Focus: -.01 to +.01	Speed: 40 - 50% Power: 100% Frequency: 1-5% Focus: -.01 to +.01
<b>Polishing</b>	600 DPI	Speed: 50 - 60% Power: 35 - 40% Frequency: 50 - 60% Focus: 0	Speed: 60 - 70% Power: 35-40% Frequency: 50 - 60% Focus: 0	Speed: 70 - 80% Power: 35 - 40% Frequency: 50 - 60% Focus: 0

# APPENDIX B: MATERIAL SETTINGS

## Fusion Series Suggested Material Settings (Fiber)

Fusion Series Suggested Material Settings (Fiber)				
Material	DPI/Freq.	20 watt	30 watt	50 watt
<p><b>Etching:</b> Like our CO2 counterparts, the slower the speed setting, the deeper the etching. However, many metal applications can be processed at higher speed settings in the range of 50-100%. Again, consider the marking requirements. If the only stipulation is permanency, you'll find the FiberMark can engrave a broad range of metals at higher speeds, regardless of laser wattage. Don't be afraid to turn up the juice!</p> <p><b>Annealing:</b> To achieve an annealed mark, the focal point should be significantly away from zero. The unfocused, broader beam provides the heat to change the surface color without actually penetrating the metal. The focal point can be either closer to or away from zero. Focusing away from the material should be in the range of -.060" to -.090". Focusing closer to the material is generally in the range of +.070" to +.110". Both focusing methods will result in a dark black annealing of the metal. Focusing up typically results in a slight indentation of the metal. Multiple passes can darken the mark even more (no data to confirm whether multiple passes offer more permanency).</p> <p><b>Polishing:</b> Some steel alloys are easier to polish than others. For best results, clean off the surface with alcohol prior to processing. Any leftover grease, oils or residue can affect how well the polished mark turns out. Polishing the metal where the final marks result in a bright white engraving requires finer tuning of settings, more so than the etched or annealed marks. Determine a base speed and frequency setting and adjust the power in small increments/decrements. If you are unable to get a white bright mark, increase the frequency setting and try again by adjusting only the power.</p>				
<b>Titanium</b>				
<b>Annealing</b>	600 DPI	Speed: 5-10% Power: 100% Frequency: 1% Focus: +.08 to +.110	Speed: 7-12% Power: 100% Frequency: 1% Focus: +.08 to +.110	Speed: 11-15% Power: 100% Frequency: 1% Focus: +.08 to +.110
<b>Etching/Marking</b>	600 DPI	Speed: 20 - 30% Power: 100% Frequency: 1-5% Focus: -.01 to +.01	Speed: 30 - 40% Power: 100% Frequency: 1-5% Focus: -.01 to +.01"	Speed: 40 - 50% Power: 100% Frequency: 1-5% Focus: -.01 to +.01
<p>Titanium and Ti alloys are highly amenable to marking at this wavelength. Similar to aluminum, a black mark from the etching process is difficult to achieve. Various shades of gray can be made, from very dark gray to light gray. Annealed marks can also be made on titanium materials using the same processing parameter described for stainless steel. Depending on the Ti alloy, marks of various colors can be achieved by changing the frequency values for 1% up to 100%. It is common to see red, blue, green, orange, yellows and purple marks, depending on the frequency selected.</p>				
<b>Plated Metals</b>				
<b>Etching/Marking</b>	600 - 1200 DPI	Speed: 10-20% Power: 100% Frequency: 1-5% Focus: -.09 to -.100" +.09 to .100"	Speed: 20-30% Power: 100% Frequency: 1-5% Focus: -.09 to -.100" +.09 to .100"	Speed: 30-40% Power: 100% Frequency: 1 - 5% Focus: -.09 to -.100" +.09 to .100"
<p>Metals are often plated to assist with conductivity, to provide a protective coating against rust and elements and for aesthetic purposes. Plating thickness will depend on application and purpose. Most of the plated metals processed through the applications lab are electronic components (to enhance conductivity) and various fittings (protection against environment &amp; rust). The typical plating thickness varies from .001" up to .005". Our recommended settings for general metal engraving works well for ablating through the plating; exposing the base metal. Ablating the plating will also provide high contrast. Using an oxidizer will enhance the look.</p> <p>Our recommended settings for polishing of metals are a good starting point where ablating through the plating isn't an option. This is likely the most common plated metal application as exposing the raw metal underneath will break continuity and / or expose the bare metal to rust and other elements. Note that the contrast of polishing of plated metals won't be as consistent or contrasting as a direct ablation. Multiple passes will help and end results will vary based on the metal used for plating, thickness of plating &amp; size of mark. Our recommended settings for annealing will often work for plated metals where the plating has a thicker wall and material used has high levels of carbon or metal oxides.</p>				

# APPENDIX B: MATERIAL SETTINGS

## Fusion Series Suggested Material Settings (Fiber)

### Fusion Series Suggested Material Settings (Fiber)

Material	DPI/Freq.	20 watt	30 watt	50 watt
<b>Powder Coating</b>				
<b>Etching/Marking</b>	600 DPI	Speed: 30 - 40% Power: 100% Frequency: 100% Focus: +.05 to .07"	Speed: 40 - 50% Power: 100% Frequency: 100% Focus: +.05 to .07"	Speed: 50 - 60% Power: 100% Frequency: 100% Focus: +.05 to .07"
Two to three passes are suggested (one pass to ablate the powder coating, 2nd or 3rd pass to polish up the metal underneath). A little less power, higher frequency and less focus adjustment will be required for the 2nd or 3rd pass, depending on the base metal. The idea is to ablate then polish. An alternative to running two or more passes is to run one pass and then use a common cleaner such as Simple Green or a citric-based cleaner with short, stiff bristle brush to scrub out the residual material remaining in the mark area. If using this technique, it may be necessary to raise or lower the marking table from around 0.07" to 0.10".				

- **These are only guidelines:** Brightness or darkness of a mark is a matter of personal preference and can be very dependent of the type of material being marked. As such, there is no "correct" setting. Working with the four different fiber settings becomes fairly intuitive in a very short period of time for most users. If you have a material that is not listed, try to compare it to similar materials listed and use those settings as your starting point.
- **Speed Settings:** The speed setting scale of 1% to 100% is not linear – i.e. 100% speed will not be twice as fast as 50% speed. This non-linear scale is very useful in compensating for the different factors that affect engraving time.
- **Power Settings:** The power settings are linear – i.e. 50% power is half as much as 100% power.
- **General Metal Engraving / Base Settings:** In the world of metals the grade, type, hardness and chemical composition are endless. Metal alloys are engineered for specific applications and have their own strengths and weaknesses. With such an unlimited selection, we've yet to come across a metal which proved to be incompatible with the FiberMark. Metals can be engraved at just about any settings. Of course, there are many variables to consider for metal engraving. The lasers wattage, hardness of metal, desired mark (etch, polish, anneal) and the required time/contrast/depth will have to be considered when deciding on the final settings.
- **General Annealing Settings:** Producing an annealed mark is very dependent on the material being out of focus. Run the laser at slow speed and full power then adjust the focus while the machine is running until you achieve the annealed mark you need.
- **Test your material:** If you do not achieve the results you are looking for with the recommended settings, try resending the job and start by changing only one variable at a time. Changing only one variable at a time will help to determine the correct setting for your material.
- Laser settings can sometimes be confusing because many materials can be marked over such a broad range of settings. If you have difficulty in finding the correct setting you can send a sample to the Epilog Laser Applications lab. We will determine if the material can be marked and provide appropriate setting for your laser.



To print a copy of these settings to keep next to your laser, go to [www.epiloglaser.com/material-settings](http://www.epiloglaser.com/material-settings).

# INDEX

## Index

### Symbols

3D Engraving 54, 161  
3-Jaw Chuck. *See* Rotary Attachment  
10/100 Network Interface Card 180  
21 CFR 1040 6  
21 CFR 1040.10 3  
21 CFR 1040.11 3  
32-bit Operating System 180  
64-bit Operating System 180  
110 Volt 15  
220 volt 15  
240 Volt 15

### A

Acrylic 162–163  
    Cast Acrylic 162  
    Cutting 163  
    Engraving 162  
    Extruded Acrylic 162  
    Suppliers 187  
    Type of Acrylic 162  
Activate a Laser 40  
Advanced Tab 54  
AirA Raster 72  
Air Assist 93  
    Acrylic Cutting 163  
    Color Mapping 56  
    Fire Warning 1  
    Plastic Cutting 168  
    Wood Cutting 173  
AirA Vector 72  
Air-Cooled 12, 179  
Air Filter. *See* Exhaust Fan  
    Laser Tube 12, 91  
Air Temperature 12  
Alder 172  
Alumamark 193  
Aluminum (Bare) 196  
Anodized Aluminum 193, 196  
    Black 163  
    Red 164  
ANSI 4  
Artwork Layout 122, 131  
AutoCAD 159–160  
Auto Delete 72  
Auto Focus 94  
    Mac Driver Setting 59

New Z-Axis Home 69  
Table Home 71

### B

Bearing Rail 87  
    Lubrication 87  
Bearings 88, 179  
    X-Axis Rail 87  
    Y-Axis Rail 88  
Bed Size 73  
Belts 179  
Beziers 31  
Blower. *See* Exhaust Fan  
Brass 196  
    Brass-Coated Steel 164  
    Painted 164–175  
    Solid 164

### C

Calibrate Joystick 73  
Camera System. *See* eView Camera Module  
Center Engraving 50, 105–107  
    Center-Center 105  
    Center-Left 106  
    Center-Top 106  
    Mac Driver Setting 59  
    Page-Center 106  
Cermark 194  
Cherry 172  
Class A 182  
Cleaning and Maintenance 85–91  
    Air Filter 91  
    Bearing Rails 87  
    Exhaust Plenum 88  
    Laser Tube 91  
    Optics 85  
CO2 Laser Match 72  
CO2 Laser Source 181  
Color Fill 174  
    Material Suppliers 187  
Color Mapping  
    Adjust Focus 101  
    Autocad 159  
    Combined Mode 103  
    Functions 99  
    Non-Mapped Colors 103  
    Object Order 102  
    Speed and Power 99  
Color Mapping Tab 56  
Computer Recommendation 180  
Config Key 70

# INDEX

- Configurations 55
- Control Panel
  - Display 65
- Cooling Requirements 12
- CorelDRAW Help 187
- CorelDraw Settings
  - Beziers 31
- Corian Supplier 187
- Cork
  - Settings 193
  - Suppliers 187
- Crash Bar 95
- Create a Cut Line 78
- Custom Artwork Designers 187

## D

- Data Light 66
- Delrin 166
- Dish Soap 166
- Dithering 53, 60, 96, 165
  - Floyd-Steinberg 97
  - Jarvis 97
  - Photograph Modes 97
  - Stucki 97
- Door Interlocks 3
  - Interlock Safety 6
- Down-Draft Ports 89
- Drive Wheel 122
- Dual Source Option 140
  - Focusing 147
  - Order of Operation 147
  - Setting Up a Dual Source Job 146

## E

- Electrical Requirements 15, 179
- Electrical Safety 4
- Emergency Stop 107
- Engraveable Medal Suppliers 187
- Engraving Direction
  - Bottom-Top 52, 60
- Engraving Techniques 161–177
- Epilog Job Manager
  - Activate a Laser 40
  - Installation 37
  - Instructions 37
  - Job Preview 44
  - Material Setting Configurations 43
  - Organizing Your Print Jobs 42
  - Program Settings 46
  - Setting up eView Camera Module 41
  - Troubleshooting Installation 39

- Vector Sorting 45
- Ethernet 11, 16, 25, 179
- Ethernet Installation 19, 25
- eView Camera Calibration
  - Overhead Camera Calibration 142
- eView Camera Module 134
  - Aligning the Camera 140
  - Associate with a Laser 41
  - Calibrate Stitching Offset 144
  - Camera Calibration Routines 141
  - Checking Camera Calibration 141
  - Fiducials 137
  - Hunting Routine 140
  - Lens Camera Calibration 143
  - Quick Print 140
  - Registration Marks 137
  - Setting Up the Job in the Epilog Job Manager 138
- Exhaust Fan 13, 109
  - Connection 13
- Exhaust Plenum 88
  - Cleaning 88
  - Fusion 40 108

## F

- Fabric
  - Suppliers 187
- FCC 182
- Federal Communications Commission 182
- Fiber Laser Match 72
- Fiber Laser Source 182
- Fiducials 137
- Finding Job History 45
- Fire Extinguisher
  - Halotron 1
- Fire Warning 1, 5, 7, 162, 163, 168, 174
- Firmware 55, 117, 126, 155
  - Upgrading 155–157
- Focus. *See* Auto Focus
  - Key 67
- Focusing a Dual Source Job 147
- Focusing Manually 93
- Focus Sub-Menu 68
- Frequency 53
  - Color Mapping 56
  - Mac Driver Setting 60
- Front Access Door 107
- Full Table Home 73

## G

- Gateway 72
- General Tab 50

# INDEX

Glass 165–175, 193  
  Engraving 165  
  Suppliers 187  
Go Button 65  
Go Table Home 72  
Go XY Home 72  
Grayscale 165, 173

## H

Hard Drive 181  
Home Position  
  Restore XY Home 70  
  Restore Z-Axis Home 72  
  Setting X-Y Home 69  
  Setting Z-Axis Home 68  
  Set XY Home 72

## I

IEC 60825-1 6  
Inside Diameter 130  
Installing Firmware 155. *See* Firmware  
Interlock Safety 6  
  Status Lights 110  
IP Address 16, 72  
IP Address Setup in the Computer 17

## J

Jarvis 165  
Job Manager. *See also* Epilog Job Manager  
  Defaults 49  
Job Manager Features 51  
Jobs Key 67  
Job Storage 75  
Job Type 51  
Jog Key 69  
Jog Laser PWR 71  
Jog Sub-Menu 69  
Joystick 65  
  Calibration 73

## K

Keypad. *See* Control Panel

## L

Landscape vs Portrait 81  
Lasable Plastics  
  Engraving Techniques 167  
  Suppliers 196  
LaserBrite™ 164

Laser Dashboard  
  Advanced Tab 54  
  Color Mapping Tab 56  
  Defaults 49  
  General Tab 50  
  Settings and Use 49–58  
  USB/Ethernet Connection 16  
Laser Engraveable Products 188  
Laser Installed 72  
Laser Match 72  
Laser On Button 67  
Laser Safety 3  
Laser Status Indicators 110  
Laser System Classification 179  
Laser TI 73  
Laser Tube 91  
  Air Filter 91  
Laser Type 51  
Leather 188, 193  
Lens. *See* Optics  
Lock Config 74

## M

Mac Driver 59–64  
  Epilog Viewer 63  
  Installation 32  
  Project Setup 62  
  Raster Settings 60  
  Sierra OS Installation 33  
  Vector Cutting Lines 63  
  Vector Settings 60  
Maintenance 85. *See* Cleaning and Maintenance  
Manifold Options 109  
Manual Focus 93  
Manufactured Wood Products 173  
Maple 172  
Marble 194  
Marble Suppliers 188  
Masking 166, 168, 174  
Material Settings 193, 196  
Material Supplier List 187  
Maximum Engraving Area 179  
Max Material Thickness 179  
MDF 173  
Medals (Engraveable) Suppliers 187  
Memory Buffer 179  
Metal Etching 175  
Metal Etching Techniques 175  
Mirror 55  
Mirrors. *See* Optics  
Mother of Pearl Suppliers 188  
Motion Control System 179

# INDEX

Movable Home Position 104  
Multiple Pages 57  
Multiple Passes 57, 167

## N

Notary Seals 166

## O

Oak 172  
Object Order 102  
Open Architecture 180  
Operating Modes 179  
Operating System 180  
Operating Temperature 12  
Optics  
    3" Lens 126  
    Cleaning 85–86  
Options 113–154  
Organizing Your Print Jobs 42  
OSHA 4

## P

Page-Center 106  
Painted Brass 164, 165, 194  
Paper/Pressboard Suppliers 188  
Passcode  
    Disable Your Passcode 74  
    Establishing a Passcode 73  
    Verify Config Locked 74  
Pause Button 66  
Pen and Pencil Set Suppliers 189  
Photo Engraving 77, 96, 194  
Photograph Modes 97  
PhotoLaser Plus 147  
    Badge Creation 152  
    Material Selection 150  
    Photograph Transformation 149  
    Setting Resolution 150  
    Setting Up 148  
    Using with CorelDRAW 151  
Piece Size 52  
Pin Table 114–116, 163  
Plastic 167–175, 194  
    Cutting 168  
    Engraveable 194  
    Engraving 167  
Plastic (Engraveable) Suppliers 189  
Plastic Marking 176  
Plated Metals 197  
Plotting 159

Plug Type 15  
Plywood 173  
Pointer Button 66  
Polish 166  
Polishing Stainless Steel 196  
Polyvinyl Chloride. *See* PVC  
Portrait vs Landscape 81  
Powder Coating 198  
Power 159, 173, 179  
    Connection 15  
    Control Panel 70  
    Laser Dashboard 52  
    Mac Driver Settings 60  
Power Comp 53, 61  
Power Connection 15  
Power Key 70  
Power Label 7  
Previewing Your Job 44  
Print Driver. *See* Laser Dashboard  
    Mac Driver 32–36  
Print Interface 179  
Print Range 57  
Processor Speed 180  
Pulse Stretch 73  
PVC 10, 168

## Q

Quick Table Home 71

## R

RAM 180  
Raster Settings 52  
Raster Type 54  
Red Dot Pointer 3, 6, 103  
    Button 66  
Reducing Engraving Time 81  
Registration Marks 137  
Regulatory Compliance 6–8  
Reset Button 66  
Reset Home Position 103  
Resolution 179  
    Difference Between Different 79  
Restore Home Position 103  
Restore Table Home 71  
Restore XY Home 70  
Rotary Attachment  
    3-Jaw Chuck 50, 126–134  
    Firmware Preparation 126  
    Fixture Plates 125, 133  
    Installation 126  
    Outside Diameter 130



# INDEX

- Setting Home 127
- Vector Speed Limitations 130
- Adjusting Your Artwork 123
- Standard Rim-Drive Rotary Attachment 117–124
  - Artwork Layout 122
  - Drive Wheel 122
  - Firmware Preparation 117
  - Installation 117
  - Removal 124
  - Setting Home 118
- Rotary Installed 73
- Rotary Options 50, 52
- Rotary Version 73
- Rubber Stamps 194
- Rulers 110

## S

- Safety Enclosure 6
- Safety Features 6–8
- Safety Interlock Indicators 110
- Safety Labels. *See* Warning Labels
- Sandblasting 166
- Selecting Registration Marks 137
- Serial Number 183
- Set Table Home 72
- Set the Fusion's IP Address 16
- Setting a Vector Cutting Line 78
- Settings Key 70
- Set XY Home 72
- Shoulders 55
- Sierra OS 33
- Slate Suppliers 189
- Software 181
- Speed and Power Control 179
- Speed Key 70
- Sports Material Suppliers 189
- Stainless Steel 194, 196
  - Annealing 196
  - Etching/Marking 196
  - Polishing 196
- Stamp Mode 54
- Stamp Settings 54
- Standard Features 179
- Status, Laser Indicators 110
- Stop / Pause Button 66
- Stretching Artwork 123
- Subnet Mask 72
- Supplier List 187
- Surge Protector 181
- System Version 74
- Sys Unit 73

## T

- Task Plate 108
- TCP/IP Address Setup in the Computer 17
- Technical Specifications 179
- Technical Support 183
- Temperature 12
- Temporary Memory 75
- Test your material 195, 198
- Thin Veneer 194
- Thumbscrews
  - Exhaust Plenum 110
- Titanium 197

## U

- Unpacking the Laser 11
- Upgrading Firmware. *See* Firmware
- USB
  - Connecting the Laser 15
  - Setting Serial Number 72
  - Windows 7 Installation 22
  - Windows 8 Installation 28

## V

- Vacuum Hold-Down Table 108, 109, 113
- Vector Cutting Table
  - Acrylic 163
  - Auto Focus 51, 94
  - Auto Focus (Mac Driver) 59
  - Control Panel Setting 72
  - Fire Warning 85
  - Installation 113
  - Plastics 168
  - Wood 173
- Vector Grid Box 51, 59
- Vector Grid In 72
- Vector Line Creation 78
- Vector Settings 53
- Vector Sorting 45
  - Inside/Out 46
  - Optimized 46
- Vector Speed Limitations 130
- Vent Cleaning 89
- Ventilation 179
- Vinyl 10

## W

- Walnut 172
- Warning Labels 6
- Warranty 191
- Wattages 179

# INDEX

## Wavelength

- CO2 Laser Source 181
- Fiber Laser Source 182

## Weight 179

## Widening 55

## Windows 7

- Ethernet Installation 19
- USB Installation 22

## Windows 8

- Ethernet Installation 25
- USB Installation 28

## Windows 10

- Ethernet Installation 25
- USB Installation 28

## Windows 32 180

## Wood 172–175, 194

- Bare Wood 172
- Cleaning 174
- Cutting 173
- Engraving 173
- Grain 172
- Plaque Suppliers 189
- Solid 172, 173
- Specialty Product Suppliers 189
- Stained 172

## X

### X Drive Version: 73

### X Home 71

### X Scale Adjust 72

### X/Y Axis Home Position 69

## Y

### Y-Axis Rail 88

### Y Drive Version 73

### Y Home 71

### Y Scale Adjust 72

## Z

### Z-Axis Home Position 68