

NOT, AND, OR

NAND

NOR

# EEL201: Digital Electronic Circuits

$$1) \overline{A + B} = \overline{A} \overline{B}$$

$$2) \overline{AB} = \overline{A} + \overline{B}$$

Department of Electrical Engineering,  
Indian Institute of Technology, Delhi,  
Hauz Khas, New Delhi 110016

$$3) A + B = B + A$$

$$4) AB = BA$$



$$5) (A + B) + C = A + (B + C)$$

$$6) (AB)C = A(BC)$$

$$7) A(B + C) = AB + AC$$

$$8) A + BC = (A + B)(A + C)$$

$$= A \cdot A + A \cdot C + B \cdot A + B \cdot C$$

Department of Electrical Engineering,

Indian Institute of Technology, Delhi

Hauz Khas, New Delhi 110016

$$= A + BC$$

$$9) A(1 + B) = A$$

$$10) A + 0 \cdot B = A$$



---

$$\overline{A+B} = \bar{A} \cdot \bar{B}$$

---

$$\overline{A+B+C} = \bar{A} \bar{B} \bar{C}$$

---

$$\overline{A+BC+D\bar{E}} = \bar{A} (\bar{B} + \bar{C}) (\bar{D} + E)$$

---

$$A(B+C)(D+\bar{E}) = \bar{A} + \bar{B}\bar{C} + \bar{D}E$$

Hauz Khas, New Delhi 110016



$$AB + CD + E$$

SUM OF  
MINTERMS

"bubble"

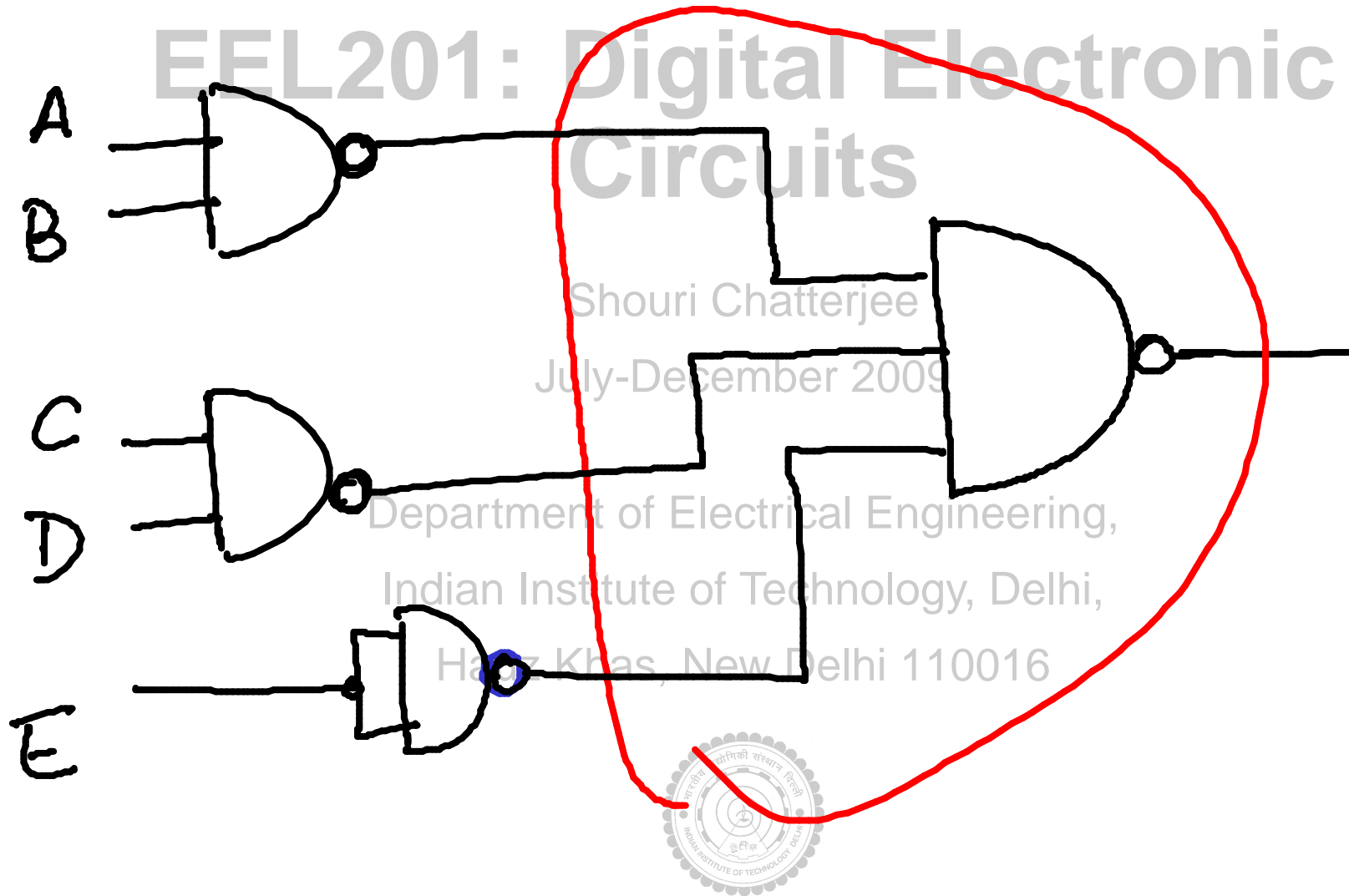

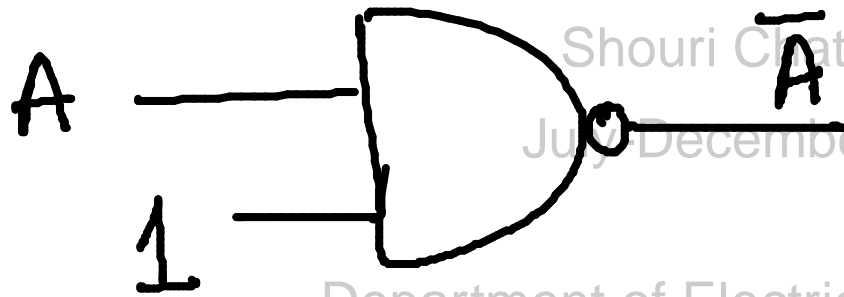
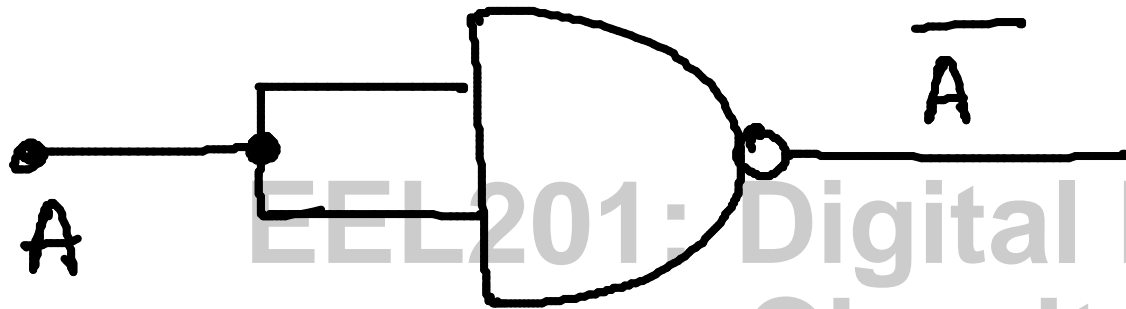

AND



OR

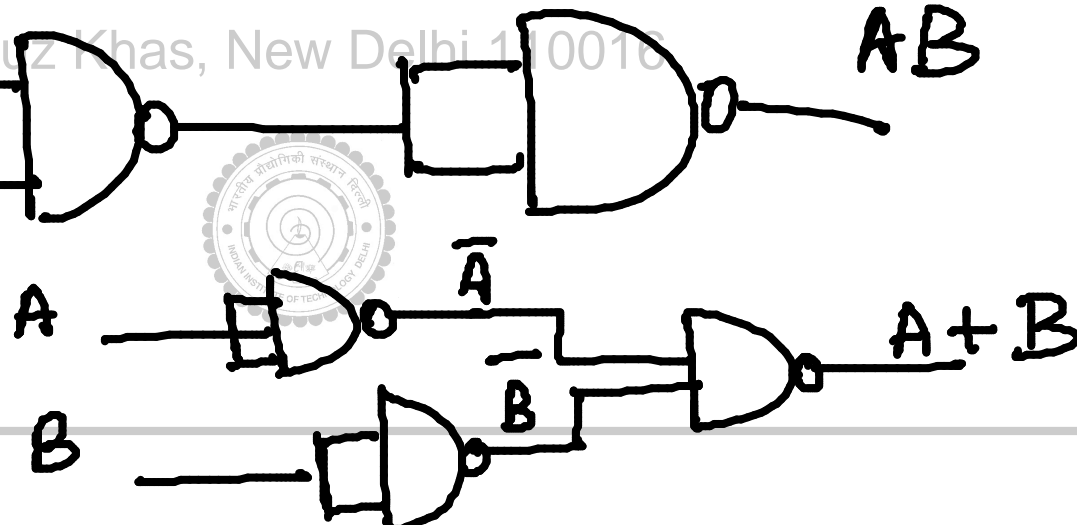

# EEL201: Digital Electronic Circuits

Shouri Chatterjee  
July-December 2009

Department of Electrical Engineering,  
Indian Institute of Technology, Delhi,  
Hauz Khas, New Delhi 110016



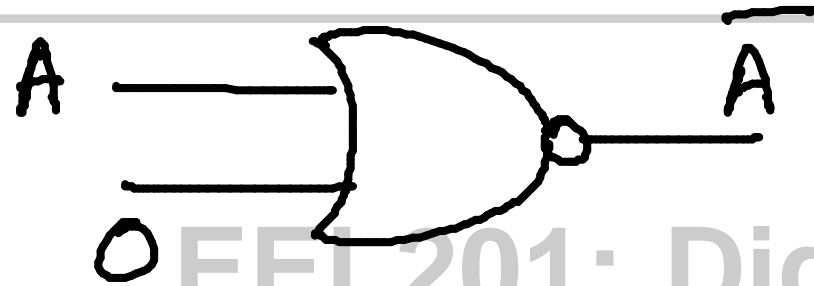

# EEL201: Digital Electronic Circuits

OR

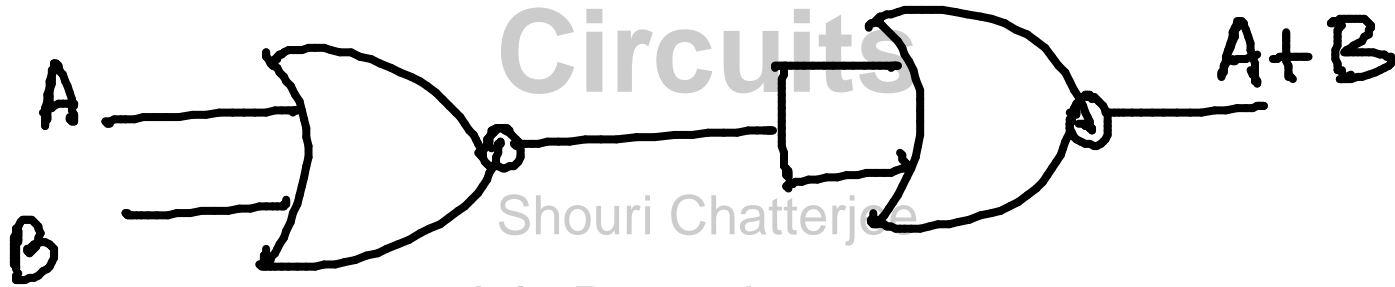

Shouri Chatterjee  
July-December 2009

AND

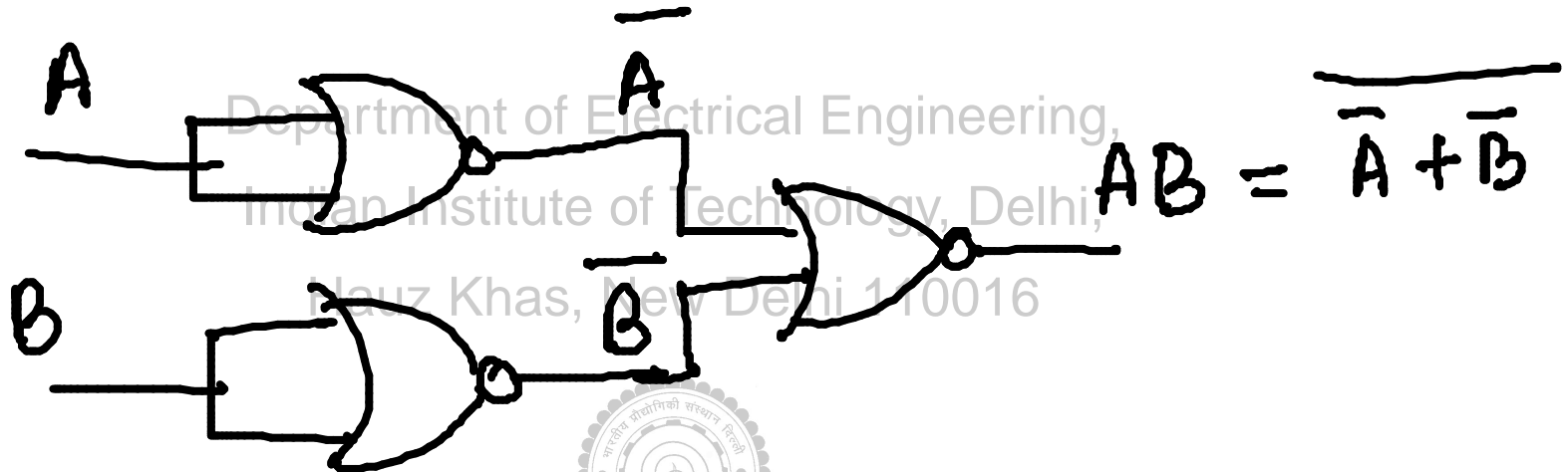

$$(A + B)(C + D)$$

PRODUCT OF  
MAXTERMS

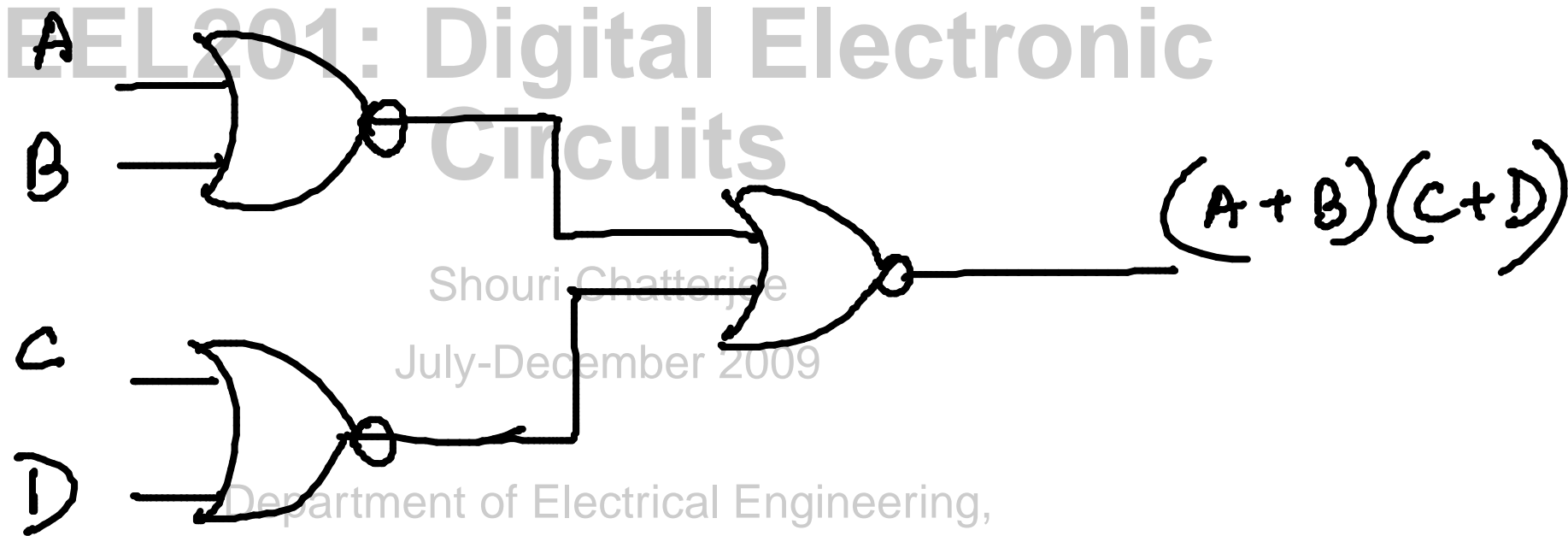

EEL 201: Digital Electronic  
Circuits

Shouri Chatterjee

July-December 2009

Department of Electrical Engineering,

Indian Institute of Technology, Delhi,

Hauz Khas, New Delhi 110016

